

AIR CONDITIONERS LINEUP

SPLIT
MULTI SPLIT
VRF
VENTILATION
AIR TO WATER



PRODUCT CATALOGUE 2016





Creation of Comfort

Fujitsu General creates high-quality and environmentally-friendly products that provide good comfort in accordance with our basic policy to a “create comfortable environment” by utilizing the air conditioning technology and creativity we have fostered over many years.

004 MISSIONS

- 006 Green Aspect for Refrigerant
- 007 Our Pioneering Efforts Make Green Future
- 008 Energy Efficiency Classifications

010 ABOUT US

- 012 Our History
- 014 Global Network
- 016 High Quality Development & Production Facilities
- 018 Global Business Activities
- 020 Project Reference

022 CORE TECHNOLOGY

- 024 High Efficiency
- 026 Energy Saving Control
- 028 Comfort Performance
- 030 Easy-to-use Control
- 032 Smart Design

034 SUPPORT

- 036 AIRSTAGE™ Support
- 038 Design Simulator
- 040 WATERSTAGE™ Support Tool
- 042 Quick Service and Maintenance

044 PRODUCT CATEGORY

- 046 2015 Fujitsu General Solutions
- 050 Split
- 090 Multi Split
- 114 Optional Parts For Split & Multi Split
- 128 VRF
- 200 Ventilation
- 208 Optional Parts For VRF
- 214 Air to Water



MISSIONS

We always keep the future in mind to ensure that the air conditioning technology that makes people comfortable is also environmentally friendly.

006 Green Aspect for Refrigerant

007 Our Pioneering Efforts Make Green Future

008 Energy Efficiency Classifications

Green Aspect for Refrigerant

EU strengthen F-Gas Regulation introduced 2014. We are active on that scenario for future.

Phase down scenario of HFC

EU strengthen F-gas Regulation introduced 2014.

New EU F-gas Regulation aims prevention of emissions and reduction the use of higher GWP F-gases.

Key elements

- Phase down approach
- Quota allocation
- Restrictions on the placing on the market
- Traceability of HFC contained in pre-charged equipment

Fujitsu General work on the reduction of HFC with innovative efforts

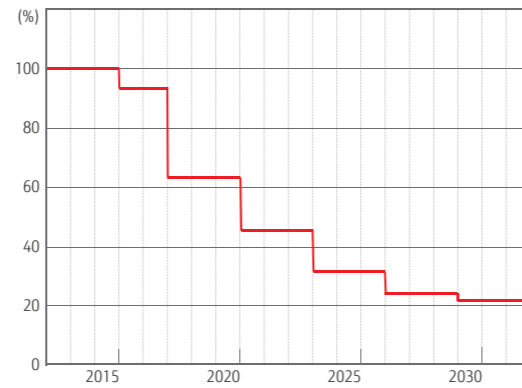

HFC phased reduction (Article 15, phased reduction from 2015)
CO₂ conversion (Compared with the production and import quantity from 2009 to 2012)

Road to 2025

From 2025, single split A/C containing less than 3 kg of F-gas (GWP_{eq} >= 750) will be banned.

As our investigation and evaluation, Fujitsu General think R32 is best balanced alternative gases. We will gradually adopt R32 for our product range.

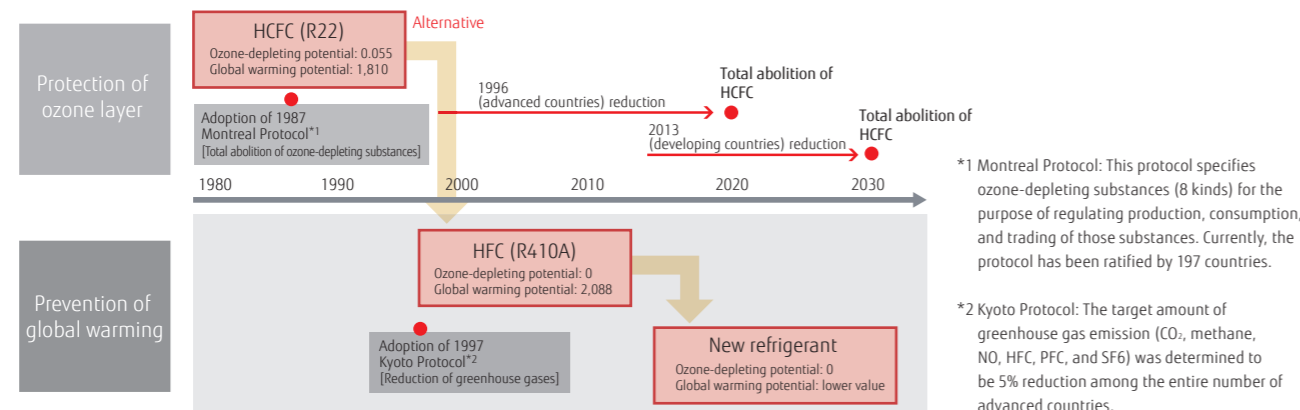

*1 Montreal Protocol: This protocol specifies ozone-depleting substances (8 kinds) for the purpose of regulating production, consumption, and trading of those substances. Currently, the protocol has been ratified by 197 countries.

*2 Kyoto Protocol: The target amount of greenhouse gas emission (CO₂, methane, NO, HFC, PFC, and SF₆) was determined to be 5% reduction among the entire number of advanced countries.



Our Pioneering Efforts Make Green Future

Approach to New Energy Efficiency Standard

Fujitsu General following The EU Climate Action Plan 20/20/20 by 2020

20% LESS
Primary Energy Use

Fujitsu General products with high efficiency and therefore low electricity input and low primary energy usage

20% LESS
CO₂ Emissions

Fujitsu General products sharply following the F-gas regulation 842/2006/EC

20% SHARE
of Renewable Energy

Fujitsu General promoting air sourced heat pumps as renewable energy source heating systems

Pursuit of Energy Saving Taking Actual Operation into Consideration

The heat load varies greatly depending on the time and season. However, the operation ratio EER or COP up to now has been calculated based on the rated value and the annual operating hours per outdoor temperatures was not taken into consideration. For this reason, SEER and SCOP* have been made the standard in terms of actual operating hours throughout the year.

*: SEER = Seasonal Energy Efficiency Ratio
SCOP = Seasonal Coefficient of Performance

Fujitsu General provides air conditioners with higher SEER and SCOP.

*SEER and SCOP are indexes that express the annual energy efficiency calculated based on the regulations of (EU) 626/2011

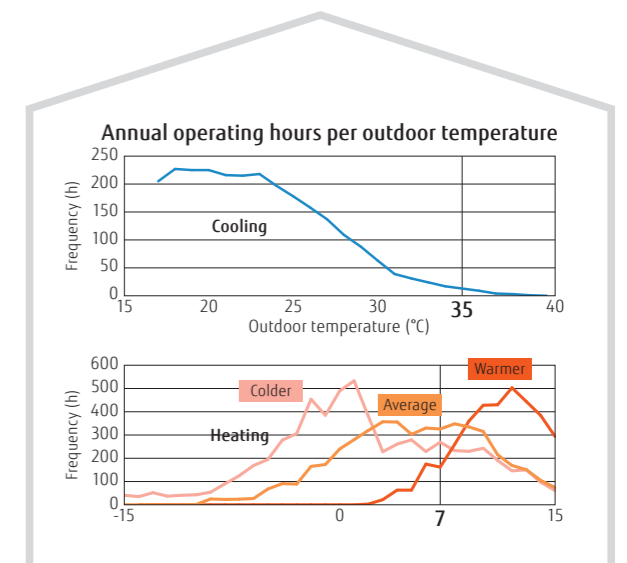

Energy Efficiency Classifications

For Air Conditioners

New Energy Labelling Requirement 626 / 2011 / EU :
Our models have reached the "Class A" ranking, the highest energy efficiency level that is now shown on energy labels in Europe.

Current Energy Label

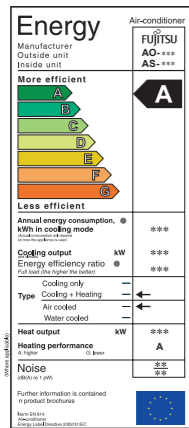

- Performance notation based on multiple points calculations that better matches the actual operation
- Energy labelling revision
- Raising of the "Class A" level

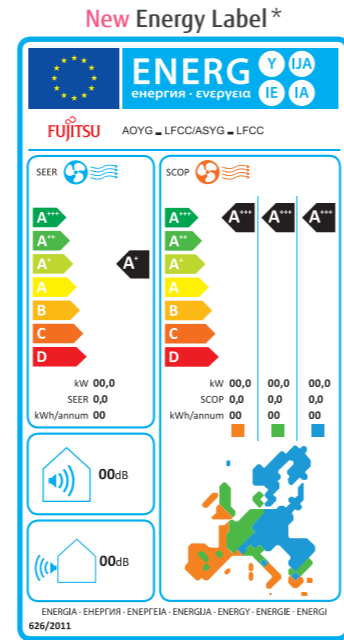

- Three climate zone for heating (Average zone: mandatory) (Warmer and colder zone are optional)
- Seasonal efficiency
- Sound power level

For Air to Water

New Energy Labelling Requirement 811 / 2013 / EU :
Our models have reached the "Class A" ranking, the highest energy efficiency level that is now shown on energy labels in Europe.

For Air to Water

	Seasonal heating efficiency (Except low temp HP)	Seasonal heating efficiency (Low temp HP)
A+++	$\eta_x \geq 150$	$\eta_x \geq 175$
A++	$125 \leq \eta_x < 150$	$150 \leq \eta_x < 175$
A+	$98 \leq \eta_x < 125$	$123 \leq \eta_x < 150$
A	$90 \leq \eta_x < 98$	$115 \leq \eta_x < 123$
B	$82 \leq \eta_x < 90$	$107 \leq \eta_x < 115$
C	$75 \leq \eta_x < 82$	$100 \leq \eta_x < 107$
D	$36 \leq \eta_x < 75$	$61 \leq \eta_x < 100$
E	$34 \leq \eta_x < 36$	$59 \leq \eta_x < 61$
F	$30 \leq \eta_x < 34$	$55 \leq \eta_x < 59$
G	$\eta_x < 30$	$\eta_x < 55$

From 26 September 2015, Ecodesign Requirements will apply to space heaters and combination heaters (including heat pumps) All these products have to meet the requirements for energy efficiency and sound power level. A printed energy label and product fiche must be provided for all products. There are three type of labels for space heaters of low-temperature, space heaters of high-temperature and combination heaters.

2015 Space heaters for high-temperature

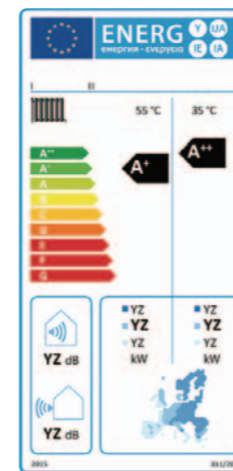

2019 Space heaters for high-temperature

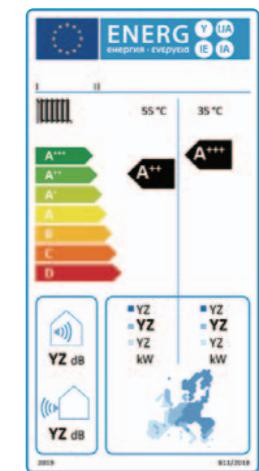

Space heaters for low-temperature

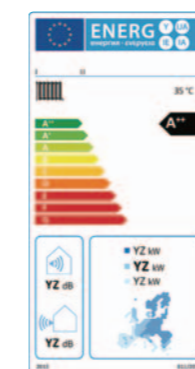

Combination heaters

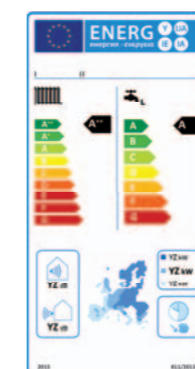

Space heaters for low-temperature

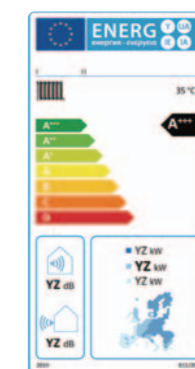

Combination heaters

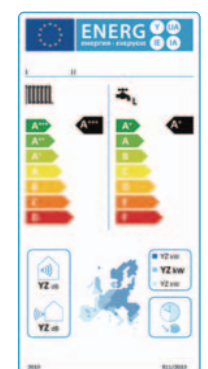

EER (Cooling mode)	COP (Heating mode)
A: $3.20 < EER$	A: $3.60 < COP$
B: $3.20 \geq EER > 3.00$	B: $3.60 \geq COP > 3.40$
C: $3.00 \geq EER > 2.80$	C: $3.40 \geq COP > 3.20$
D: $2.80 \geq EER > 2.60$	D: $3.20 \geq COP > 2.80$
E: $2.60 \geq EER > 2.40$	E: $2.80 \geq COP > 2.60$
F: $2.40 \geq EER > 2.20$	F: $2.60 \geq COP > 2.40$
G: $2.20 \geq EER$	G: $2.40 \geq COP$

Gradual ranking regulation up to A+++ (2013 ~ 2019)

- 2013~: A, B, C, D, E, F, G
- 2015~: A+, A, B, C, D, E, F
- 2017~: A++, A+, A, B, C, D, E
- 2019~: A+++ , A++, A+, A, B, C, D

* Enforcement on January 1, 2013 Air conditioners below 12 kW

SEER (Cooling mode)	SCOP (Heating mode)
A+++ : $SEER \geq 8.50$	A+++ : $SCOP \geq 5.10$
A++ : $6.10 \leq SEER < 8.50$	A++ : $4.60 \leq SCOP < 5.10$
A+ : $5.60 \leq SEER < 6.10$	A+ : $4.00 \leq SCOP < 4.60$
A : $5.10 \leq SEER < 5.60$	A : $3.40 \leq SCOP < 4.00$
B : $4.60 \leq SEER < 5.10$	B : $3.10 \leq SCOP < 3.40$
C : $4.10 \leq SEER < 4.60$	C : $2.80 \leq SCOP < 3.10$
D : $3.60 \leq SEER < 4.10$	D : $2.50 \leq SCOP < 2.80$
E : $3.10 \leq SEER < 3.60$	E : $2.20 \leq SCOP < 2.50$
F : $2.60 \leq SEER < 3.10$	F : $1.90 \leq SCOP < 2.20$
G : $SEER < 2.60$	G : $SCOP < 1.90$

Current Energy Labelling Points

Rated efficiency

- Full capacity
- One point temperature condition

→ EER COP

Operating power consumption

Sound pressure level

Annual efficient operation

Reduce total power consumption

Low noise products

New Energy Labelling Points

Seasonal efficiency

- Integrates part load capacity
- Optimised for several rating temperatures

→ SEER SCOP

Total power consumption

- Operating power consumption
- Standby power consumption
- Crank case heater
- Thermo off

Sound power level

New criteria



ABOUT US

Since we began our air conditioning business in 1971, our products have been popular around the world and we continue to improve them.

012 Our History

014 Global Network

016 High Quality Development & Production Facilities

018 Global Business Activities

020 Project Reference

Our History

1960
Air conditioning business starts.
Japan-domestic business starts.

1971
Air conditioner exports to Middle East.

Overseas Air Conditioning Business since

1971



1977
"Super Power, Super Quiet" series

1982
Window type 3 Super series
AL/AX series

1985
Large wall mounted and multi air conditioner introduced.

1991
Air conditioner with the world's first lambda heat exchanger



1995
Air conditioner with the world's first power diffuser



2001 AIRSTAGE™ series is released. VRF air conditioners for large-sized buildings.



2006 VRF Heat Pump type Max. 42 HP
AIRSTAGE V



2004 Small VRF series
AIRSTAGE J

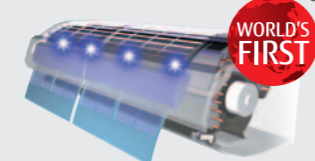

2003 **nocria™**
Air conditioner with the world's first automatic self-cleaning filter system



2009
VRF Heat Pump type Max. 48 HP
AIRSTAGE V-II



2009
Air to Water system is released.
WATERSTAGE™



2012 VRF Heat Recovery type Max. 48 HP
AIRSTAGE VR-II



2011 Small VRF series
AIRSTAGE J-II



2011
Hi-spec Design model



2014 The small VRF series is small & light weight outdoor unit.
AIRSTAGE J-IIS



2014
Air to Water system Monobloc type: Compact series
WATERSTAGE™



2014-2015
VRF Heat Pump type Max. 54 HP
AIRSTAGE V-III



2015-2016
New Wall Mounted & Cassette/Duct models

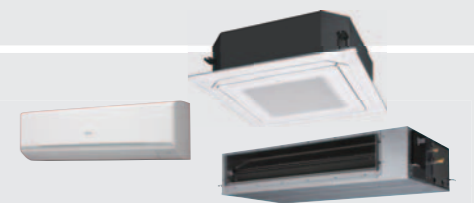

2015-2016
New Air to Water system
WATERSTAGE™



2016
New Small VRF series
AIRSTAGE J-III



1936 Established as Yaou Shouten Ltd.

~1999

2000-2010

2011-2015

2016 TOPICS

Manufacturing Company Establishment

1955
Headquarters in Kawasaki

1964
Electronic components factory in Ichinoseki

1977
Air conditioner manufacturing company in Hamamatsu (now Hamamatsu business office.)

1991
Air conditioner manufacturing company in Thailand.

1994
Air conditioner manufacturing company in Shanghai, China.

1998
Air conditioner motor manufacturing company in Thailand.

2006
VRF air conditioner manufacturer, sale, and service company in China.

2007
Air conditioner technology building completed on Main Office group. Air conditioner R & D Center in Kawasaki

2009
Operation of compressor factory begins in Thailand.

2012
Joint venture in Thailand to manufacture compressors

2016
Commercial use air conditioner R & D Center in Thailand



Sales Company Establishment

1976
North America sales company

1977
Europe sales company (UK)

1978
Australia sales company
Europe sales company (Germany)

1980
Brazil sales company

1997
Asia sales company (Singapore)

1998
Middle East sales company (UAE)
New Zealand sales company

2000
Air conditioner manufacturing and sale technical partnership in India

2002
Taiwan sales company

2006
China sales company

2013
Moscow representative office

Global Network

Fujitsu General's air conditioning business has acquired a major share of the overseas market. We have many production and sales facilities overseas, and we continue to develop and sell products that are accepted around the world by their "easy-to-use and environmentally-friendly technology".

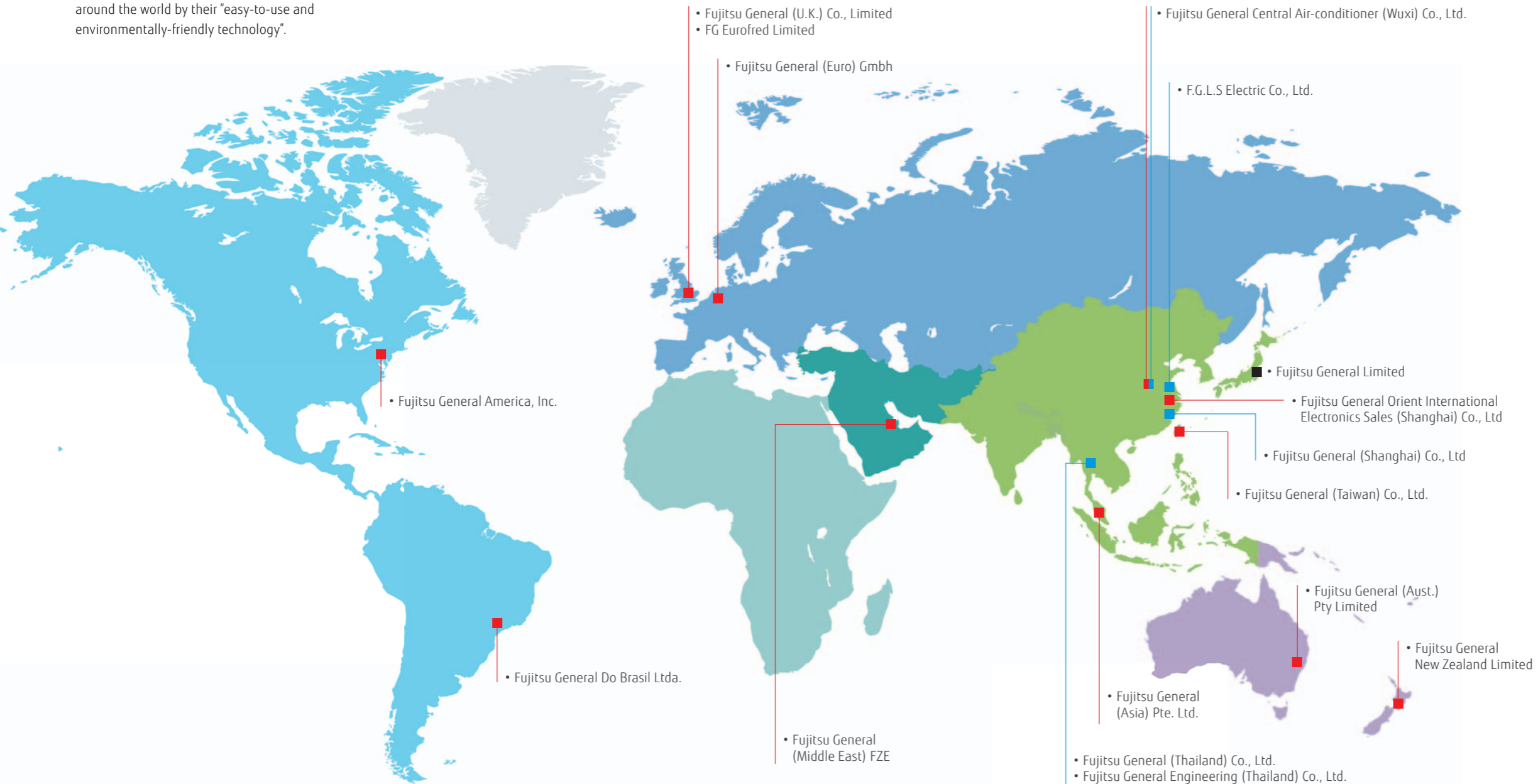

Fujitsu General (Shanghai) Co., Ltd.



F.G.L.S. Electric Co., Ltd.



Fujitsu General Central Air-conditioner (Wuxi) Co., Ltd.



FGA (Thailand) Co., Ltd.



Fujitsu General (Thailand) Co., Ltd.
Fujitsu General Engineering (Thailand) Co., Ltd.



TCFG Compressor (Thailand) Co.,Ltd.

JAPAN Head Office
R & D Center and 60 m Height Difference Testing Tower

11 Overseas Sales Companies &

- Head Office
- Sales Companies
- Manufacturing Companies

6 Overseas Manufacturing Companies



High Quality Development & Production Facilities

Advanced Research Facility and Equipment

Performance Testing



Air flow testing Calorimeter testing Sound testing

Reliability Testing

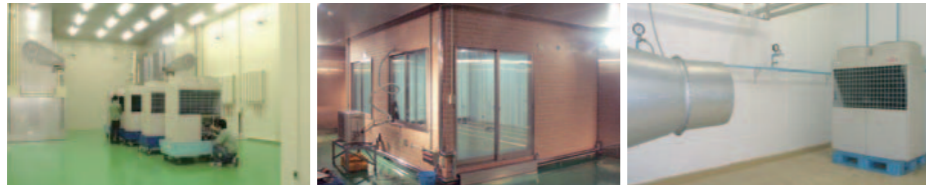

Severe environmental testing Water shower testing Vibration testing

Transportation & Handling



Compressibility testing



Vibration testing

Testing Laboratory

Fujitsu General EMC Laboratory Limited

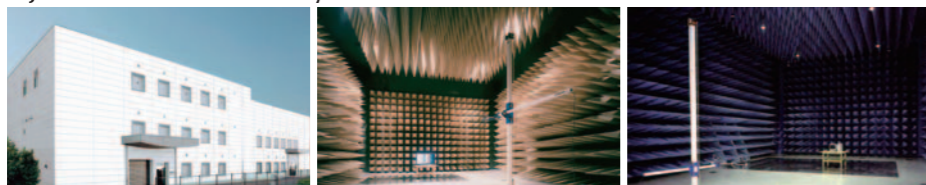

60 m Height Difference Testing Tower

Objective is to confirm oil circulation of compressor for reliability



Acquisition of ISO 9001 and ISO 14001



High Product Quality Assurance

All Fujitsu General factories have acquired ISO 9001, and have built a quality control system common around the world. High quality products are offered to all over the world based on stringent quality inspections.

Receiving inspection

Parts procurement requires a supplier's test report. European regulation RoHS inspection is also performed by special test department in-house. Total number inspection is performed especially on main parts to remove defectives.

Stringent product quality inspection

Stringent quality inspection is carried out at all production processes. High quality is maintained by stringent checks by inspectors and repetitive inspection.

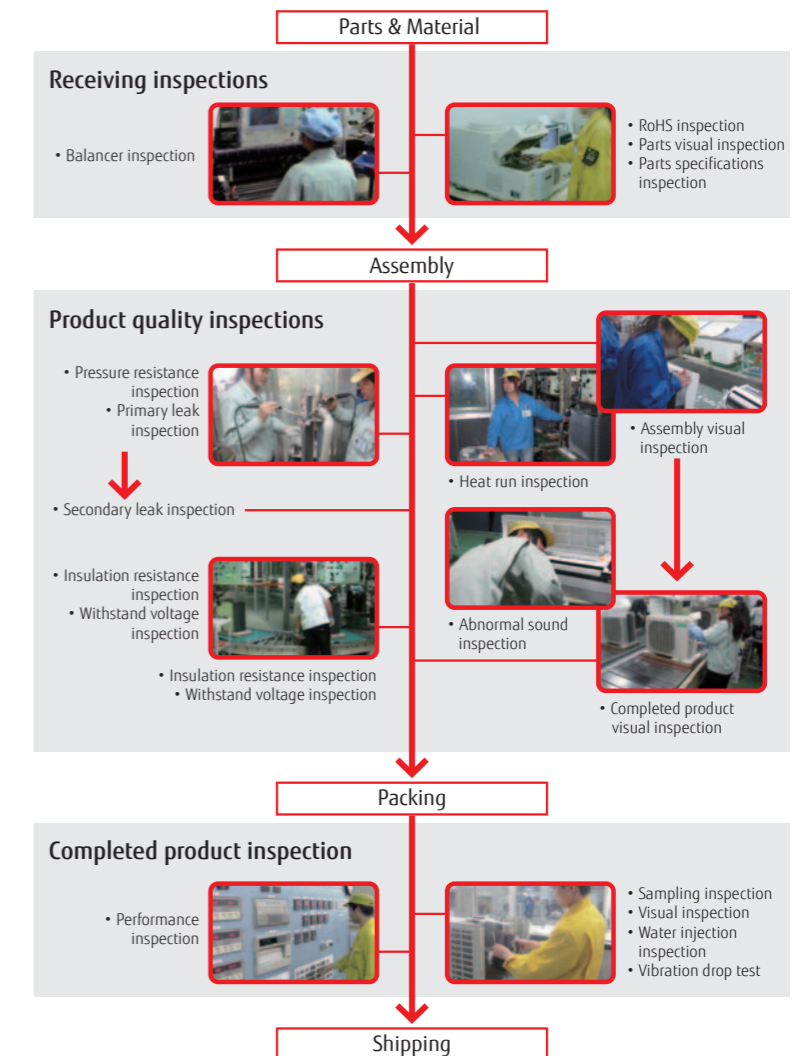

Global Business Activities

We are engaging in advertising, human resource development, CS activities, and social contribution activities worldwide. These activities have been recognized throughout different regions by the awards we have been honored with.

America



HVAC trade show in Brazil

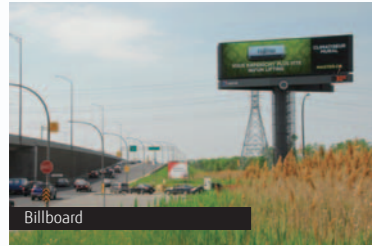

Billboard



Distributor meeting



Call center



"Dealer Design Awards" of "the NEWS"



Gold Award (Category: HVAC & PLUMBING) in Reader's Choice Awards



TOP OF MIND 2016" First prize in "MARCA DE EQUIPAMENTODE AR-CONDICIONADO" category of "CLIMATIZACAO" division

Middle East



Distributor meeting



Technical seminar



Training for dealers

Europe



HVAC trade show in Europe countries



Presentation & training

International authoritative design awards



The iF Product Design Award is given each year by "iF International Forum Design GmbH" for industrial products from around the world.



reddot design award winner 2012

The product design competition has existed since 1955. Its award, the "red dot", is an internationally recognised quality seal.

Oceania



HVAC trade show in Australia



Charity (Christchurch)



Service & Maintenance

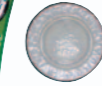

Coolworld Industry Awards "Most Efficient Air Conditioner"



Canstar Blue Most Satisfied Customers Award

Asia



Distributor meeting



Presentation for sales companies



SE training



Call center



China State Construction Engineering Luban Prize



The Good Design Award is sponsored by the Japan Institute of Design Promotion and is awarded once a year for an item of excellent design.



Project Reference

The VRF is popular because of its high quality, energy saving, and easy installation, and so has been installed in a wide range of building types including high-rise office buildings, stores, hotels, public facilities, schools, and hospitals.

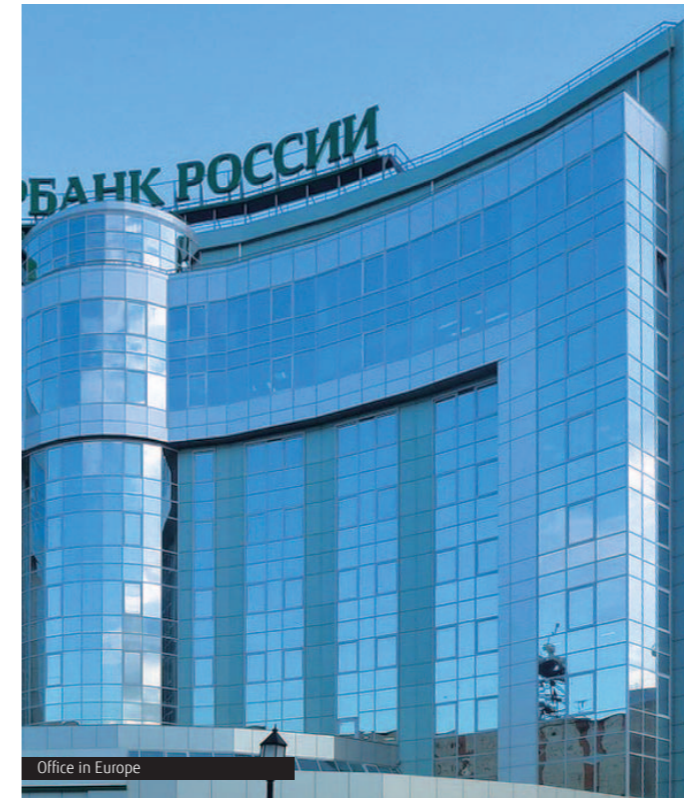

Fujitsu General's VRF has been installed in over 50 countries worldwide.



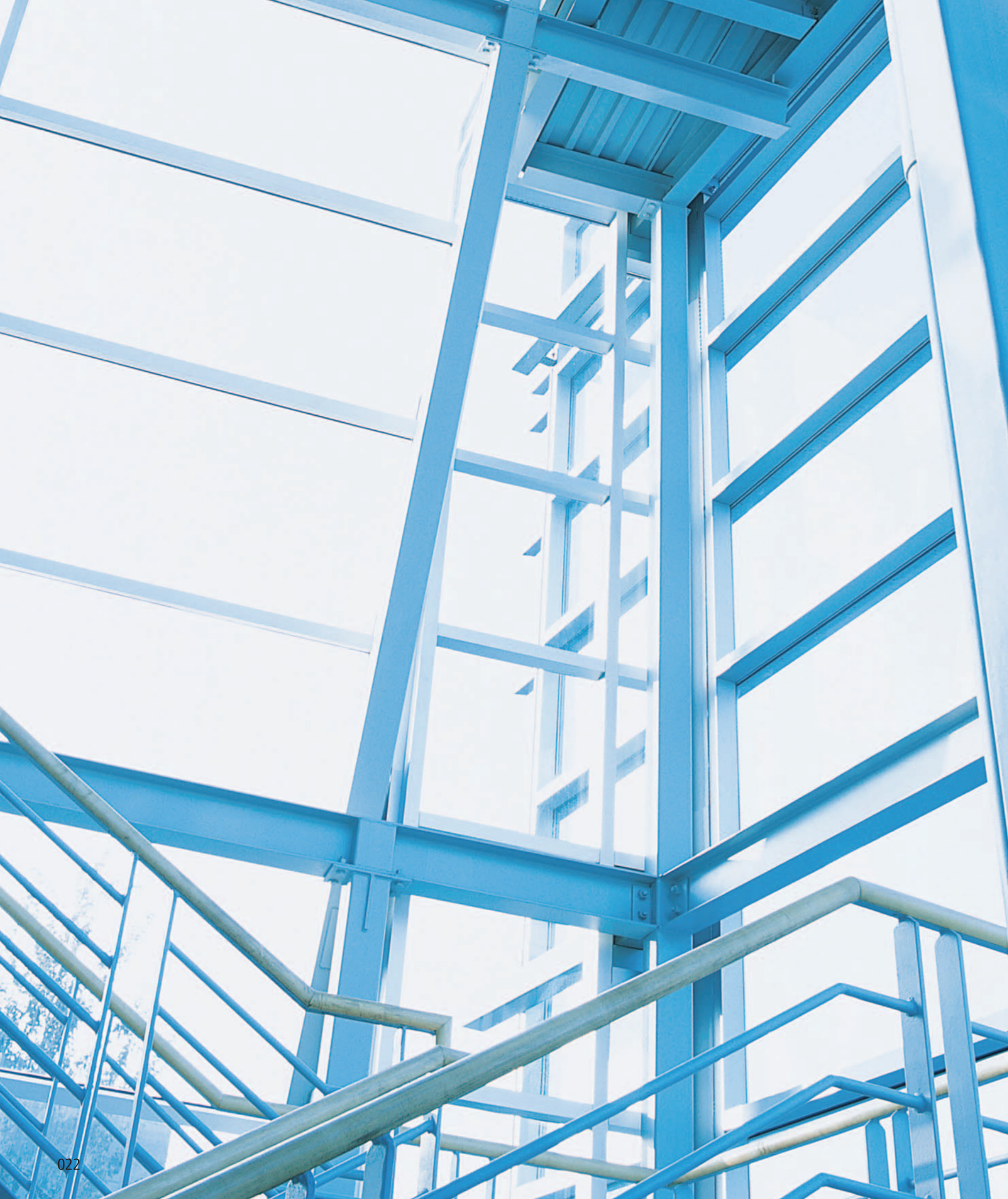

CORE TECHNOLOGY

Our advanced technology is providing comfort in a wide variety of situations from residential applications to commercial use.

- 024 High Efficiency
- 026 Energy Saving Control
- 028 Comfort Performance
- 030 Easy-to-use Control
- 032 Smart Design



Pursuit of Seasonal Efficiency

Over 90% of actual operation time, air conditioners are operated at partial capacity instead of rated capacity. We focused on high seasonal efficiency by all DC inverter control and high efficiency technology.

CORE TECHNOLOGY

High Efficiency

Optimized Inverter Control



i-PAM (IPM*+PAM) inverter control

i-PAM inverter control is a technology which reduces loss by adjusting the current waveform to a better sine waveform. This promotes the effective use of the input power supply to attain high performance.
IPM*: Intelligent Power Module



V-PAM (Vector + I-PAM) inverter control

V-PAM inverter control reduces the effects of magnetic flux and increases the maximum speed and efficiency of the compressor by vector control technology. With this technology, further miniaturization, higher efficiency, and better performance are attained.



All DC Inverter Technology



DC twin rotary compressor

The high efficiency DC inverter type "2-cylinder rotary compressor" is used for our product ranges. It has achieved higher energy efficiency compared with similar compressors by optimizing the structure inside the compressor.

DC fan motor

DC fan motor produces high power, wide operation range, and high efficiency.

Sine-wave DC inverter control

High efficiency operation is realized by using a sine wave DC inverter control.



High Efficiency Heat Exchanger

High density multi-path heat exchanger

Heat exchange performance is substantially improved by thin and high-density heat exchanger and multi-path efficiency technology.

High performance sub-cool heat exchanger

Higher performance achieved by mounting of counter type bypass circuit. (Large multi type, VRF)

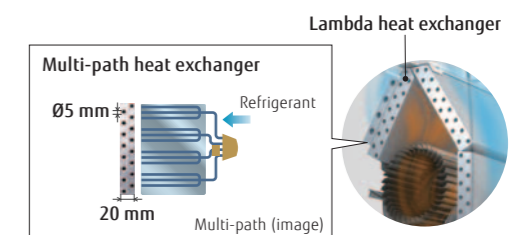



It's Smart Operation

CORE TECHNOLOGY

Energy Saving Control

Smart Operation



Human sensor control

Human sensor catches movements of people in a room, and operates with lower capacity when people leave the room. When people come back to the room, it automatically returns to the previous operating mode.



Economy operation

Limits the maximum operation current, and the power consumption is cut down and the maximum load is suppressed.



Room temperature set point limitation

The minimum and maximum temperature range can be set giving further energy saving while considering the comfort of the occupants.



Set temperature auto return

- The setting temperature automatically returns to the previous setting temperature.
- The time range in which the set temperature can be changed is 10 to 120 minutes.



Auto-off timer

- The indoor unit is turned off automatically when it reaches to the preset operating time frame.
- The time frame of the "Auto off timer" can be flexibly scheduled.
- Off time can be set from 30 to 240 minutes.

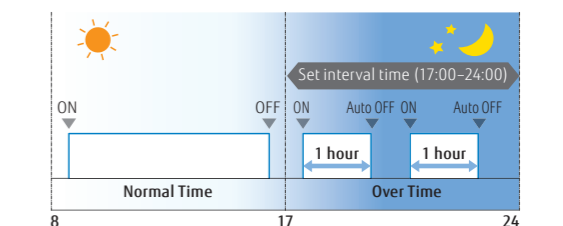
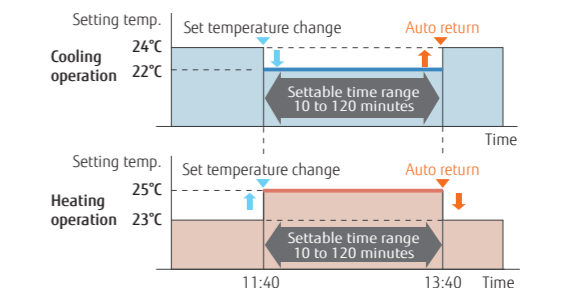
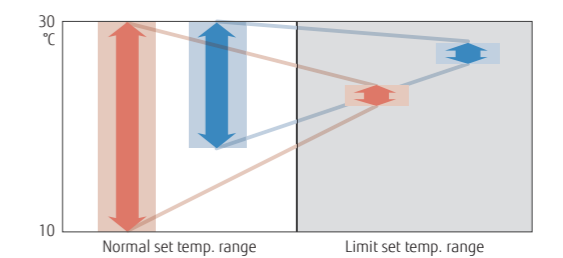
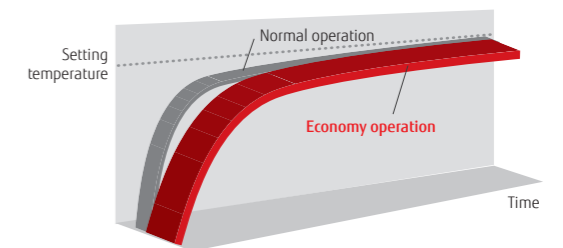
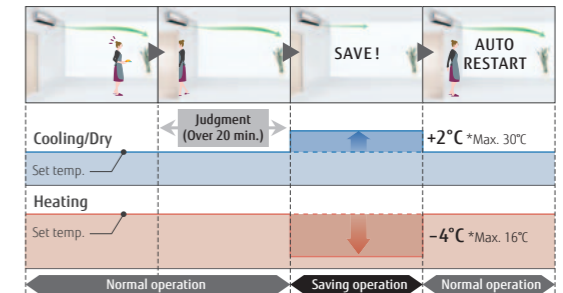

Comfort Performance

Quick Comfort



Power diffuser

Precision wind direction control is realized and ventilation efficiency is also improved by 3 technologies. Our airflow control makes your environment more comfortable.

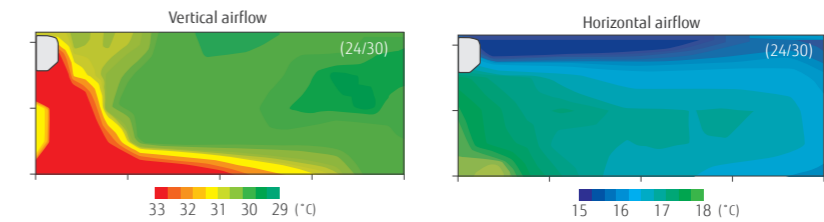

Powerful operation

Continuous operation by maximum airflow and maximum compressor speed after a certain period of time allows the temperature to reach the setting temp. quickly.

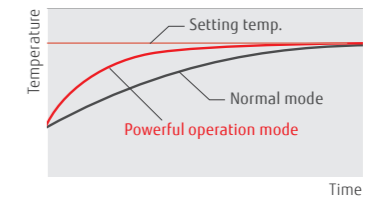

10°C HEAT operation

When you leave, minimum heating operation is performed to maintain the room temperature. (Maintained at 10°C)

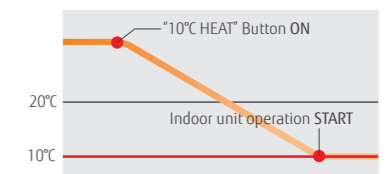

Quiet and Comfort Control



Outdoor unit low noise operation

Users can choose low noise levels, depending on the installation environment. The operation time can be set using the timer.

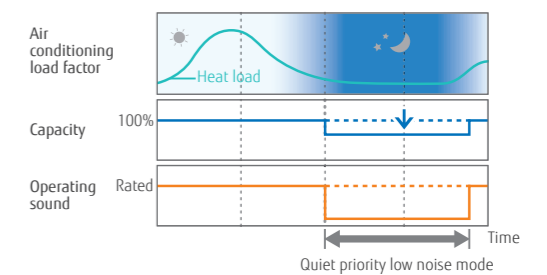

Auto-changeover function

At Auto setting, the cooling/heating mode is automatically switched according to the set temperature and room temperature.

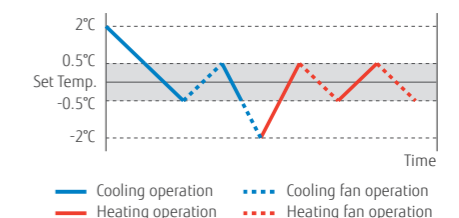

Powerful Heating

High heating capacity is realized even at low outdoor temperature by mounting a large heat exchanger or large DC rotary compressor and developing high performance inverter PCB



Easy air conditioner control from inside or outside the house and office using the Smartphones, Tablets, and PC

It is the most advanced solution to remotely manage an Air Conditioning system using all sort of mobile devices such as Smartphones, Tablets, and PC.

CORE TECHNOLOGY

Easy-to-use Control

Fujitsu General provides Various Easy-to-use Controllers

Fujitsu General is using ergonomics to expand the use of easy-to-use designs such as easy-to-read large LCD panels, easy-to-operate buttons, and displays with easily recognizable icons.

The individual controllers match the user operational environments, and the home controller makes batch energy saving management easy. Ease of use was pursued using simple operation buttons, a large LCD screen, and other features.

Residential use



Home central control



Central Remote Controller

Simple individual control



Wired Remote Controller



Simple Remote Controller



Slim Wireless Remote Controller

Commercial use



Each floor or Small building management control



Touch Panel Controller

Individual & Simple central control



Wired Remote Controller



Wired Remote Controller (Touch Panel)

Large building management control



System Controller

Software

Fujitsu General provides an interface that supports central management systems such as KNX®, MODBUS®, BACnet®, and LONWORKS®. This allows customers to easily perform central control and monitoring of air conditioning equipment.

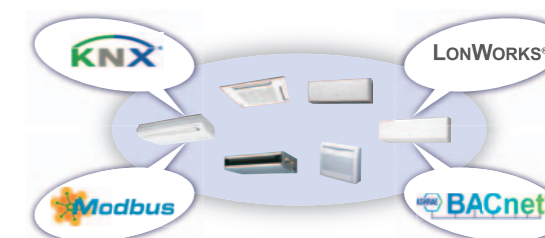

NEW



CORE TECHNOLOGY

Smart Design

Standard Range Series
New Design & Large Capacity
ASYG30LMTA
ASYG36LMTA

Creating Harmony and New Interior Design Space in a Variety of Installation Environments

Thinness and simplicity was thoroughly pursued in this design to fit the interior design. The lambda shaped high-density multi-path heat exchanger construction and full cover slide open panel provide both beauty and functionality. The remote controller has also been designed utilizing ergonomics for ease of use while also pursuing beauty even in the details. Fujitsu General provides its customers with highly functional air conditioners designed with high artistic sensitivity



Designer Range Series
High Spec & Design
ASYG09LTCA
ASYG12LTCA



Standard Range Series
High Efficiency & Comfort
ASYG07LMCA
ASYG09LMCA
ASYG12LMCA
ASYG14LMCA



Designer Range Series
High COP
ASYG07LUCA
ASYG09LUCA
ASYG12LUCA
ASYG14LUCA



ECO Range Series
Compact & Comfort
ASYG07LLCC
ASYG09LLCC
ASYG12LLCC



GOOD DESIGN
reddot design award
winner 2012



SUPPORT

Our know-how supports you not only during the product release but also from guiding implementation to product maintenance.

- 036 AIRSTAGE™ Support
- 038 Design Simulator
- 040 WATERSTAGE™ Support Tool
- 042 Quick Service and Maintenance

AIRSTAGE™ Support

Technical information

We provide information and tools that are useful for air conditioning system design, such as unit performance data and tools that make model selection and estimation easy.

Features

- Design & Technical Manual
- Model Selection & Estimation
- Certificate Data
- 2D/3D CAD Data

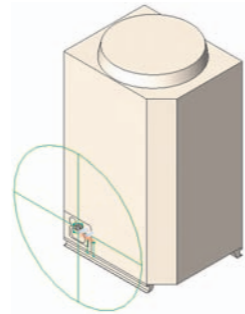

Product information

New product information is provided in the form of documents and movies for every new model released. These can be downloaded from a private section of our website. To access this website, please contact your Fujitsu representative.

Features

- Product News
- Brochures & All Manuals
- Feature Promotion Movie



Technical support

Technical support is provided at every stage from design to installation to assist in providing the most suitable air conditioning solution.

Features

- CFD Simulation
- Guide line
- Commissioning Support

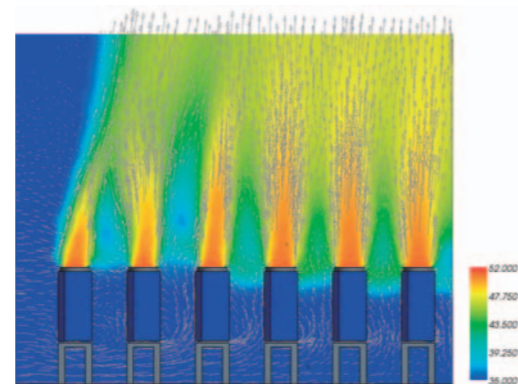

CFD Simulation



Commissioning Support

Fujitsu General provides a variety of product and technical information to engineers and consultants, and also conducts new product research and design support activities.

We provide a wide range of support to maintain high quality from design to installation.

Training

Fujitsu General has many training facilities around the world that regularly conduct specialized product, technical, and service training. These research facilities also support the development of people with high technical capability.

Features

- Designing AIRSTAGE™ Systems
- Control System on-site training



Head Office Training Center: Japan



Europe Training Center: U.K.



America Training Center: U.S.A.

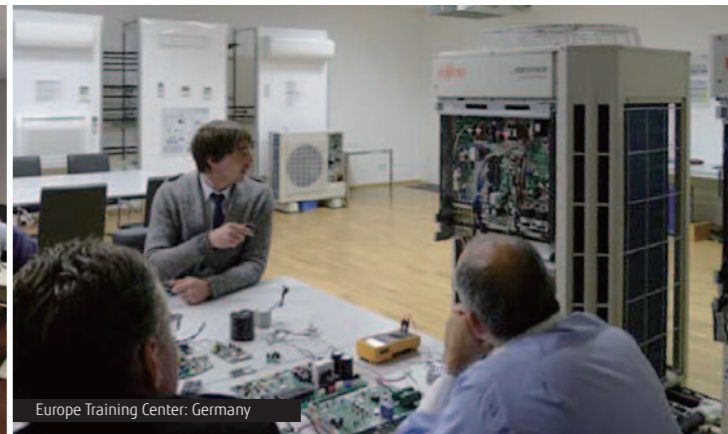

Europe Training Center: Germany



China Training Center: China



Asia Training Center: Singapore



Middle East Training Center: UAE



Oceania Training Center: Australia

Design Simulator

Automatically create model selection information

- Each unit can be automatically set by entering the required performance, type, and temperature conditions for each indoor unit and then dragging and dropping into the outdoor unit.
- Piping and wiring diagrams can be created automatically and it is easy to set branches, grouping, and options.
- The additional refrigerant charging amount is automatically calculated when the pipe length is entered.
- It is also easy to set the remote controller groups, central controller and converters.
- The equipment list including the equipment information is created automatically.

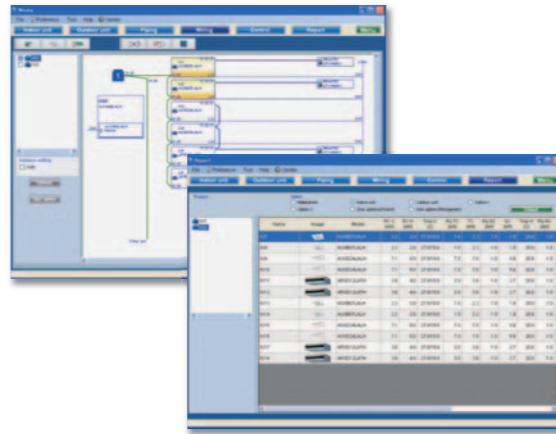

Output the format that matches the application

The information specific to your project can be exported in a number of industry standard file formats.

- Word format (rtf)
- Excel format (csv)
- Auto CAD format (DXF)
- 2D Data (DXF)
- 3D Data (RFA)

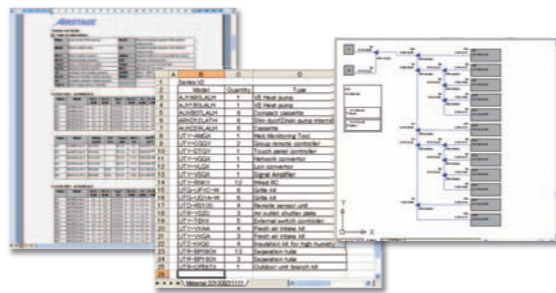

Update your Design Simulator

Database can be easily updated online using AutoUpdate function through FTP.

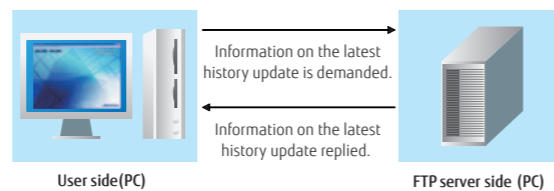

BIM Building Information Modeling

Fujitsu General provides the Building Information Modeling (BIM) object models and contents for our VRF system and some products to the architect, designer and contractor using Autodesk® Revit® technology from our Website and Autodesk® Seek Website, etc.

3D and 2D product data

We provide 3D data that closely resemble the actual product appearance. 2D CAD design operations are supported and 2D display is also provided. The data can also be output in other formats, such as DXF and DWG, which are used by other design CAD.

Installation information

Other information, such as symbols showing the airflow direction that are required for installation drawings, is built in and can be automatically reflected in 2D drawings. Installation drawings can be created easily.

Installation limitation

The equipment installation limitation range is shown. Installation requirements, such as distance from the wall, is automatically displayed to make it easy to produce highly reliable layout designs.

Product specifications & link information

Contains the basic information required for air conditioner design, including unit size, capacity, input power, noise, and airflow rate. These data can be procured from the Fujitsu General Website, Design Simulator, and Autodesk® Seek Website.

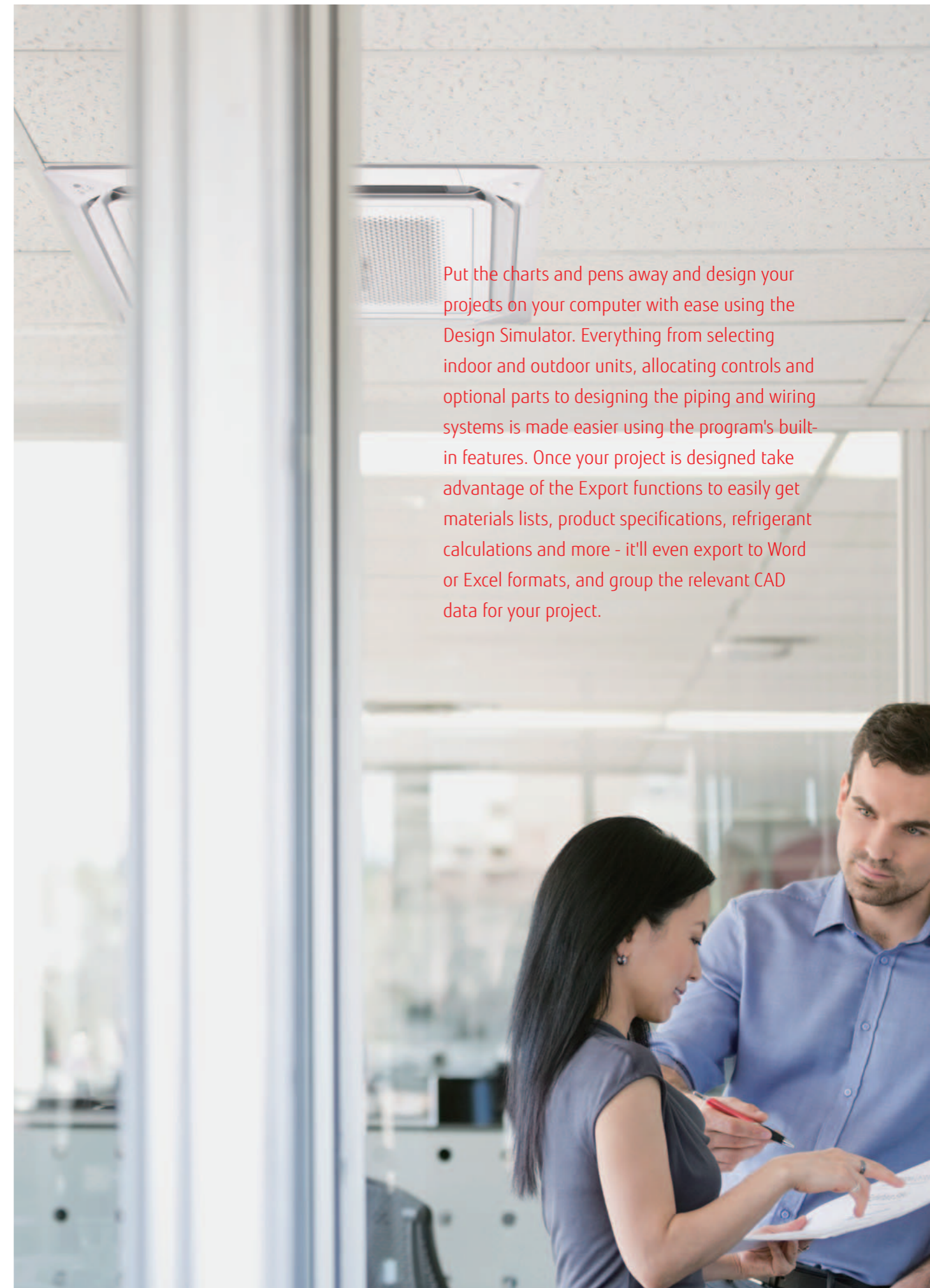

Put the charts and pens away and design your projects on your computer with ease using the Design Simulator. Everything from selecting indoor and outdoor units, allocating controls and optional parts to designing the piping and wiring systems is made easier using the program's built-in features. Once your project is designed take advantage of the Export functions to easily get materials lists, product specifications, refrigerant calculations and more - it'll even export to Word or Excel formats, and group the relevant CAD data for your project.

WATERSTAGE™ Support Tool

Model selection with detailed technical information

- The software automatically selects the equipments just by inputting some factors, like the region where the equipment is installed, required capacity to heat up the space, and a heating method.
- The transition in the equipment capacity at each outdoor temperature condition and/or when back up heater is under operation can be easily created by this software.

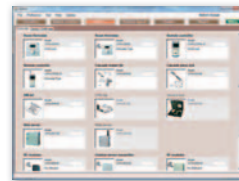

The visible images of the optional items enables the correct configuration of the systems. All of the associated optional items are automatically chosen in a case the application requires several devices of the WATERSTAGE™ equipments.



The entire system configuration can be reviewed and modified once the units are selected. And by seeing the images and the list of equipments at the same time, it avoids mistake in the selection of equipments.



The software automatically provides graphs of monthly running cost, CO₂ emission volume, cost comparison against other heating sources, and other data to allow the users to see at a glance the financial benefit of choosing WATERSTAGE equipments.

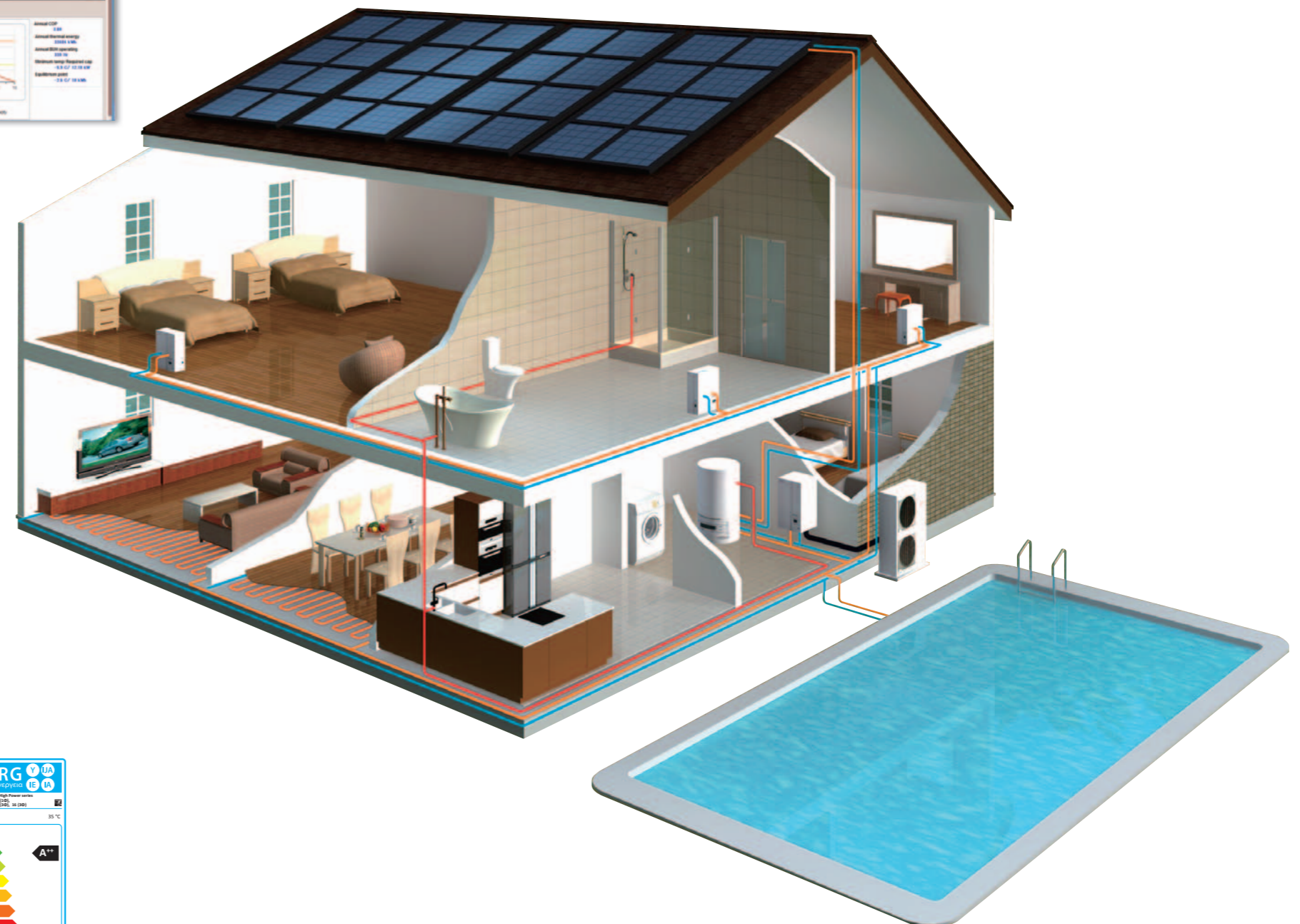

Fujitsu General's new software for the WATERSTAGE™ automatically provides a combination of WATERSTAGE™ equipments just by giving few parameters. The software is featured with multiple languages, and automatic update function.

Energy labels and Fiches can be downloaded from our homepage

You can find and download the ErP documents (energy labels, product fiches, pre-configured package labels, pre-configured package fiches, information sheets and EC Declaration) from our homepage.

In addition, we will provide a internet service to allow the various package labels and package fiches to be created easily by installers in the future.

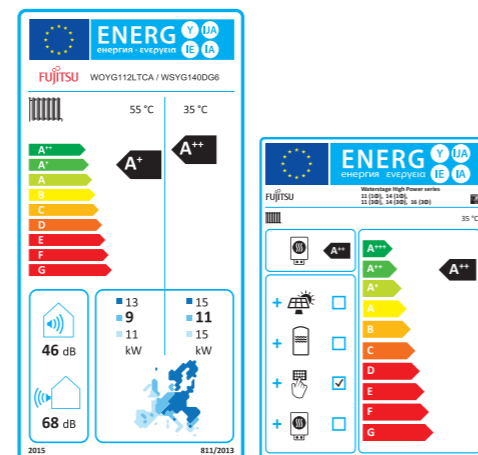

Quick Service and Maintenance

Design for easy maintenance

The air conditioner operating status and trouble status of the detailed are displayed at the 7-segment of the outdoor unit PCB or on the remote controller screen. The unit status can be checked rapidly and quick response is also possible.

- Operation mode status
- Discharge temperature/Pressure status
- Compressor operation indication
- Address/Type/Number of outdoor unit
- Error code.

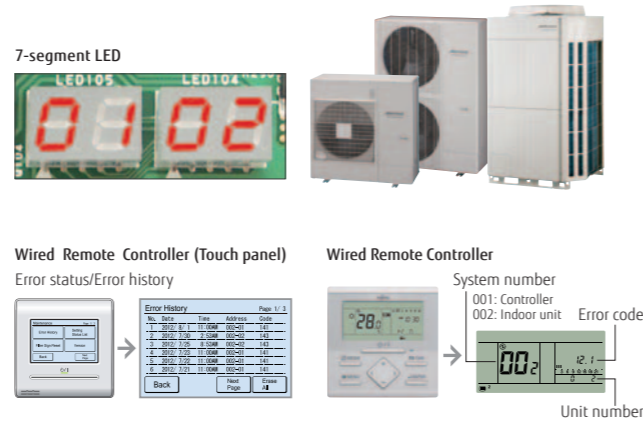

Error diagnosis by Service Tool

The unit status details from single split models to VRF system can be checked on PC screen by connecting Service Tool. Quick countermeasures can be taken

- Operation status/control
- Monitoring operating condition
- Monitoring sensor data
- Indication of trend graph
- Error history
- Indication of refrigerant circuit diagram (For VRF)

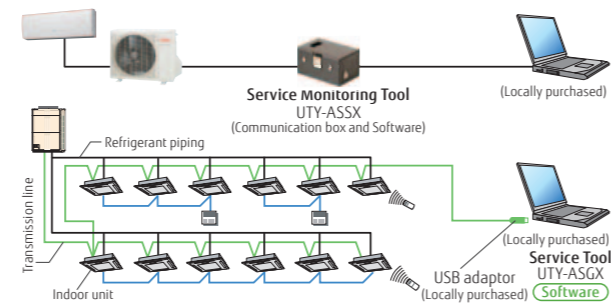

Remote monitoring

VRF system operating status and trouble status details can be constantly and remotely monitored over the Internet, etc. Rapid cooperation with the service personnel are also possible.

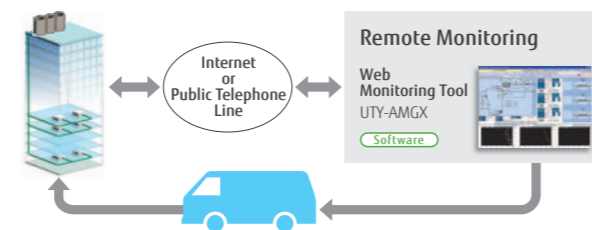

Mobile troubleshooting tool for iPhone

We will release an App of troubleshooting tool for iPhone, iPod touch and other Apple products. This application is a troubleshooting tool for Fujitsu General air conditioner (RAC/PAC, VRF)

It helps you to check air conditioner condition. Error code check, Troubleshooting, and Sensor check are available.



If trouble should occur in a unit or system, abundant support tools such as trouble code display at the product, Service Tool that allows checking of the detailed status of the entire system, and remote monitoring tool that uses the internet, etc. support quick service and maintenance anywhere and at any time.



PRODUCT CATEGORY

046 2016 Fujitsu General Solutions

050 SPLIT

090 MULTI SPLIT

114 OPTIONAL PARTS for SPLIT & MULTI SPLIT

128 VRF

200 VENTILATION

208 OPTIONAL PARTS for VRF

214 AIR TO WATER

2016 FUJITSU GENERAL SOLUTIONS

NEW SPLIT

Large Wall Mounted

- 30/36 class. Standard Range
- High seasonal energy efficiency
- Energy saving control with Human sensor



Large Cassette

- 18 to 54 class. 6 models
- Unique Circular Flow design/Uniform air distribution by the seamless airflow louver
- Individual louver control



Medium Static Pressure Duct

- 12 to 54 class. 8 models
- High efficiency & Quiet operation by new structure design
- Adopting Automatic Airflow adjustment function
- Improved installation flexibility



NEW MULTI SPLIT

Simultaneous Multi

- 36 to 54 class. Single phase 3 models



NEW OPTIONAL PARTS For SPLIT and MULTI SPLIT

Controller

- Easy-to-use and highly-functional controllers
- The room temperature can be controlled accurately with built-in thermo sensor.
- Built in weekly/daily timer (ON/OFF, Weekly)

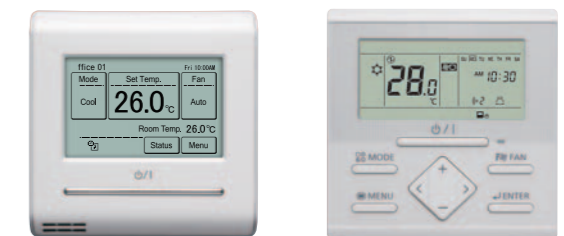

MODBUS® Convertor

- The MODBUS Convertor can be connected to MODBUS Network system.
- Simple installation due to small and compact size
- The MODBUS Convertor permits central monitoring and control of air conditioners from BMS.



Wireless LAN Interface

- Mobile application control for single indoor units and multi system indoor units.
- Control basic operation (ON/OFF, Mode, Fan, Room temp., Louver position)
- Error display & E-mail notification





NEW VRF

AIRSTAGE™ J-III

- 4/5/6 HP class. Single phase/3 phase 6 models
- High energy efficiency



Mini Duct

- 7 to 24 class 6 models
- Compact design of Depth 450 mm and Height 198 mm
- Installation is possible even in narrow ceiling space
- In spite of compact model, V-shaped heat exchanger, large fan casing, and optimized airflow path achieve significant low noise.



High Static Pressure Duct

- 96 class high energy efficiency
- Wide static pressure range of 0 to 300 Pa
- 5 static pressure selection



NEW OPTIONAL PARTS For VRF

Touch Panel Controller

- Up to 400 indoor units can be controlled.
- Remote control and remote monitoring functions
- Electricity charge apportionment function added (option)



Convertor

- Network convertor can be connected to single split 2 types of DC power supply type and AC power supply type are available
- MODBUS® Convertor can be connected to MODBUS Network

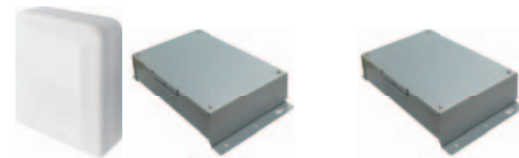

Network Convertor

MODBUS® Convertor



NEW AIR TO WATER

Split, Split DHW Integrated and Monobloc types

- Corresponding to the new ecodesign standard
- All models 5 kW to 16 kW class. 21 models



SPLIT



























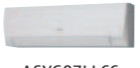
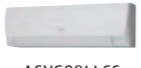
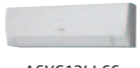

































Energy saving design to provide a comfortable indoor environment while being environment-friendly.

An air conditioner that is people-friendly is also environment-friendly. Fujitsu General offers a broad lineup of products from large living rooms to bedrooms and children's rooms. We make your room more comfortable with a wide range of air conditioner types from ceiling wall type with automatic filters and cleaning functions to wall mounted type that improve the air cleaning function. Of course these models feature highly efficient operation that conserves electricity.

9 types 64 models

- 052 All Type Lineup
- 054 Feature Explanation
- 056 Wall Mounted
- 068 Floor
- 070 Floor/Ceiling
- 072 Ceiling
- 074 Compact Cassette
- 076 Cassette
- 080 Slim Duct
- 082 Medium Static Pressure Duct
- 086 High Static Pressure Duct

All Type Lineup

Type	Series	BTU							BTU						
		4	7	9	12	14	18	24	30	36	45	54	60	72	90
Wall Mounted Page 56 -	Designer Range Series High Spec & Design														
	Designer Range Series High COP														
	Standard Range Series High Efficiency & Comfort														
	NEW Standard Range Series New Design & Large Capacity														
	Standard Range Series Comfort for Large Room														
	ECO Range Series Compact & Comfort														
Floor Compact & Comfort Page 68															
Floor/Ceiling Comfort & Dual Design Page 70															
Ceiling Comfort for Large Room Page 72															
Compact Cassette Page 74	4-way Flow Series Compact & Comfort														
Cassette Page 76 -	4-way Flow Series Comfort for Large Room														
	NEW Circular Flow Series Comfort for large room														
Slim Duct Slim & Comfort Page 80															
Medium Static Pressure Duct High Efficiency & Comfort Page 82															
NEW Medium Static Pressure Duct Compact & Comfort Page 84															
High Static Pressure Duct Page 86 -															
															

Feature Explanation

Energy Saving Function

- Save human sensor**
Human sensor detects the movement of people in the room and judges whether the energy saving operation.
- Save & Stop human sensor**
Human sensor detects the movement of people in the room and judges whether the energy saving or stop operation.
- Room temperature set point limitation**
The minimum and maximum temperature range can be set giving further energy saving while considering the comfort of the occupants.
- Set temperature auto return**
The setting temperature automatically returns to the previously set temperature.

Economy mode
Thermostat setting automatically changes according to the temperature to avoid unnecessary cooling and heating.

Comfortable Function

- Powerful heating**
Keeping the rated heating capacity even when the outdoor ambient temperature is -7°C.
- Power diffuser**
An additional louver that opens based on monitoring sensors to quickly enhance immediate comfort needs.
- Powerful mode**
Operation at maximum air flow and compressor speed, and quickly makes the room comfortable.
- 10°C HEAT operation**
The room temperature can be set to go no lower than 10°C, thus ensuring that the room does not get too cold when not occupied.
- Auto-changeover**
The unit automatically switches between heating and cooling modes based on your temperature setting and the room temperature.
- Up/down swing flaps**
The up/down flaps automatically swing up and down.
- Automatic fan speed**
The micro-computer automatically adjusts the airflow effectively to follow the changes of room temperature.
- Double swing automatic**
Complex swing action of flaps enables automatically to swing both horizontal and vertical directions.
- Fresh air intake**
Fresh air can be taken in by a fan which can be connected using external control unit.
- Restart**
In the event of a temporary power failure, the air conditioner will automatically restart in the same operating mode as before, once power supply is restored.
- Connectable distributing duct**
Systems are capable of attaching Locally purchased branch ducts distributing the airflow.
- Individual airflow direction control**
Each louver of 4-way Cassette type can be controlled individually and provides comfortable airflow.

Convenient Function

- Auto off timer**
Automatically stops operation when a fixed time has elapsed from the start of operation.
- Sleep timer**
The micro-computer gradually changes the room temperature automatically to afford a comfortable night's sleep.
- Weekly timer**
Different ON-OFF times can be set for each day.
- Weekly + setback timer**
Weekly + Setback timer can set temperature for two times spans and for each day of the week.
- External error output**
- External ON/OFF input**
- Program timer**
This digital timer allows selection of one of four options: ON, OFF, ON + OFF or OFF + ON.
- Filter sign**
Indicates the filter cleaning period by lamp.

Clean Function

- Ion deodorization filter**
The filter deodorizes by powerfully decomposing absorbed odors using the oxidizing and reducing effects of ions generated by the ultra-fine-particle ceramic.
- Apple-catechin filter**
The Apple-catechin filter uses static electricity to clean fine particles and dust in the air.
- Washable panel**
Since the front panel is easy to remove, maintenance is also easy.

Installation

- Automatic airflow adjustment**
Automatically detects required airflow in each application case and adjust the volume.
- Drain pump as standard**
- Blue fin**

ALL DC All DC models

i-PAM i-PAM control models
i-PAM inverter control is a technology which reduces loss by adjusting the current waveform to a better sine waveform.

V-PAM V-PAM control models
V-PAM inverter control reduces the effects of magnetic flux and increases the maximum speed and efficiency of the compressor by vector control technology.

Feature Summary

	Wall Mounted	Floor	Floor/Ceiling	Ceiling	Compact Cassette	Cassette	Slim Duct	Medium Static Pressure Duct	High Static Pressure Duct
Energy Saving Function									
Save human sensor	●	●							
Save & Stop human sensor								○	
Economy mode	●	●	●	●	●	●	●	●	●
Room temperature set point limitation	○	○	○	○	○	○	○	○	○
Set temperature auto return	○	○	○	○	○	○	○	○	○
Comfortable Function									
Powerful heating	●								
Power diffuser		●		●					
Powerful mode	●	●	●	●	●				
Server room operation				●					
10°C HEAT operation	●	●	●	●	●	●	●	○	○
Low Noise mode	●	●	●	●			○ (45/54) ○ (36/LRTA)	○ (45/54)	○ (45) ○ (36/LMLA)
Auto-changeover	●	●	●	●	●	●	●	●	●
Up/down swing flaps	●	●	●	●	●	●	●	○	
Double swing automatic				●	●	●			
Automatic fan speed	●	●	●	●	●	●	●	●	●
Auto restart	●	●	●	●	●	●	●	●	●
Connectable fresh air duct							●	○	●
Fresh air intake							○	○	○
Connectable distributing duct							●	●	●
Individual airflow direction control							●		
Convenient Function									
Auto off timer	○	○	○	○	○	○	○	○	○
Sleep timer	●	●	●	●	●	●	●	○	○
Program timer	●	●	●	●	●	●	●	○	○
Weekly timer	●	●	●					●	●
Weekly + setback timer	○	○	○	○	○	○	○	○	○
External error output	○	○	○	○	○	○	○	○	○
External ON/OFF input	○	○	○	○	○	○	○	○	○
Filter sign	●	●	●	●	●	●	●	●	●
Clean Function									
Ion deodorization filter	●	●	●	●	●	●			
Apple-catechin filter	●	●	●	●	●	●			
Washable panel		●	●	●	●	●			
Installation									
Automatic airflow adjustment									●
Drain pump as standard								●	●
Blue fin		●	●	●	●	●	● (30/36/45/54)	● (45/54)	● (30/36/45/54)

○: Optional function



Wall Mounted Designer Range High Spec & Design

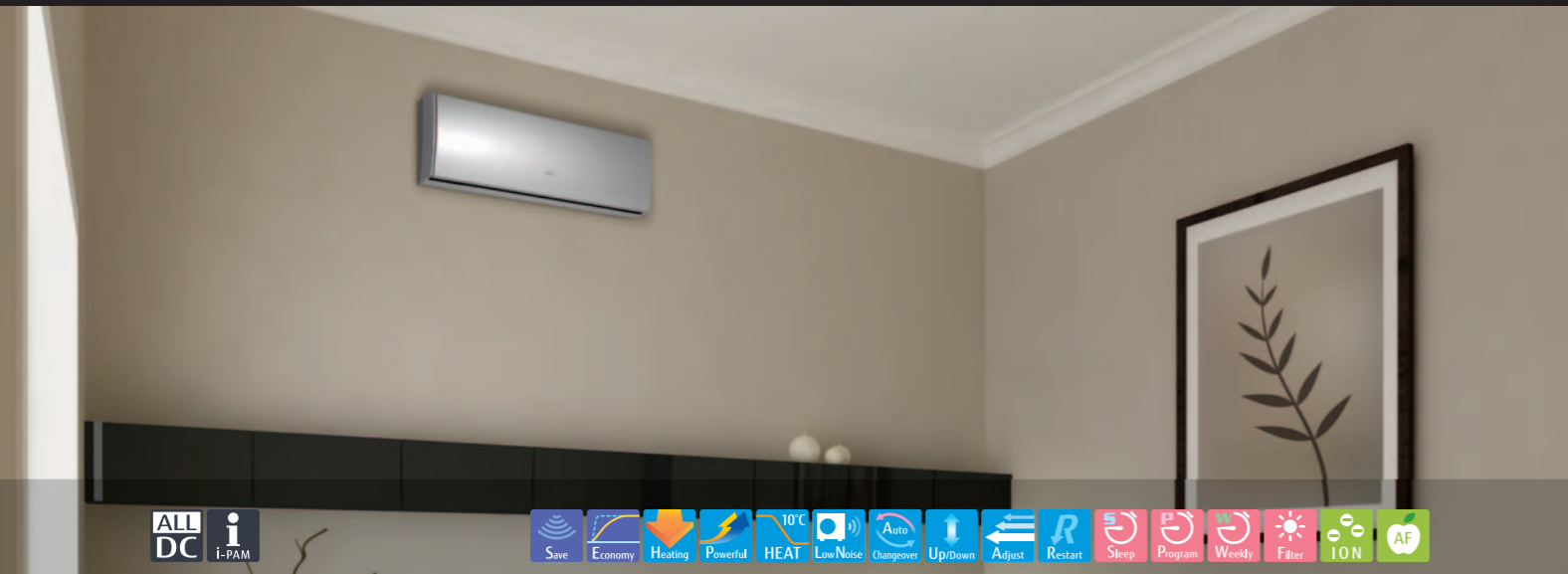

Features

Thin & Slim design

Thin and slim design is realized by high density multi-path heat exchanger and high efficiency wind blower.

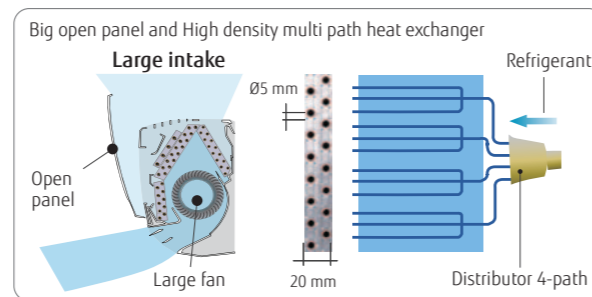

Human sensor

Human sensor catches movements of people in a room, and operates with lower capacity when people leave the room. When people come back to the room, it automatically returns to previous operating mode.



Powerful heating

Rated heating capacity is maintained up to an outdoor temperature lower than -7 °C. This new model can operate even at -20 °C low outdoor temperature.

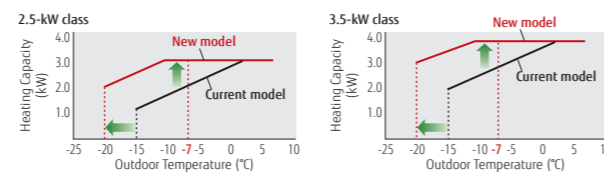

3 Mode timer (Weekly/Program/Sleep)

Weekly timer can be easily set by wireless remote controller. ON, OFF can be set up to 4 times in 1 day and up to 28 times in 1 week. For other modes, program timer and sleep timer can be also selected by one push.



Low ambient operation

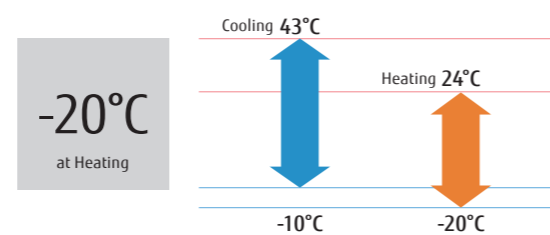

Model: ASYG09LTCA / ASYG12LTCA



Wireless R.C.



For ASYG09LTCA



For ASYG12LTCA

Specifications

Model No.	Indoor unit		ASYG09LTCA		ASYG12LTCA		
	Outdoor unit		AOYG09LTC		AOYG12LTC		
Power Source	Single-phase, ~230V, 50Hz						
Capacity	Cooling	kW	2.5 (0.9-3.5)		3.5 (1.1-4.0)		
	Heating	kW	3.2 (0.9-5.4)		4.0 (0.9-6.5)		
Input Power	Cooling/Heating		0.505/0.660		0.850/0.910		
EER	Cooling	W/W	4.95		4.12		
	Heating	W/W	4.85		4.40		
Pdesign	Cooling/Heating(-10°C)		2.5/3.0		3.5/4.0		
SEER	Cooling		8.50		8.50		
SCOP	Heating (Average)		4.60		4.60		
Energy Efficiency Class	Cooling		A+++		A+++		
	Heating (Average)		A++		A++		
Max. Operating Current	Cooling/Heating		A		A		
Annual Energy Consumption	Cooling		103		144		
	Heating		912		1217		
Moisture Removal			1.3		1.8		
Sound Pressure Level	Indoor (Cooling)	H/M/L/Q	42/36/32/21		43/37/32/21		
	Indoor (Heating)	H/M/L/Q	42/37/32/21		43/38/32/21		
	Outdoor (Cooling/Heating)	High	48/50		48/49		
Sound Power Level	Indoor (Cooling/Heating)	High	59/61		60/62		
	Outdoor (Cooling/Heating)	High	63/65		64/65		
	Indoor / Outdoor	High	800/1,700		850/2,050		
Airflow Rate			mm		mm		
			282×870×185		282×870×185		
Net Dimensions H x W x D			kg(lbs)		kg(lbs)		
			9.5 (21)		9.5 (21)		
Weight			mm		mm		
			540×790×290		620×790×290		
		kg(lbs)		kg(lbs)			
		33 (73)		40 (88)			
Connection Pipe Diameter (Liquid / Gas)			mm		mm		
				6.35/9.52		6.35/9.52	
Drain hose Diameter (I.D./O.D.)			mm		mm		
				13.8/15.8 to 16.7		13.8/15.8 to 16.7	
Max Pipe Length (Pre-Charge)			m		m		
				20 (15)		20 (15)	
Max Height Difference			m		m		
				15		15	
Operation Range	Cooling		°CDB		°CDB		
	Heating		-10 to 43		-10 to 43		
Refrigerant	Type (Global Warming Potential)		R410A (2,088)		R410A (2,088)		
	Charge		g		g		
				1,050		1,200	

Optional parts

Wired Remote Controller: UTY-RNNYM / UTY-RVNYM

Simple Remote Controller: UTY-RSNYM

Communication kit: UTY-TWBXF

Dimensions

(Unit : mm)

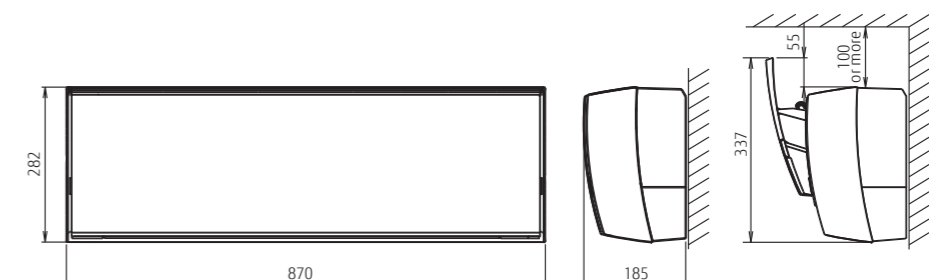

Wall Mounted Designer Range High COP

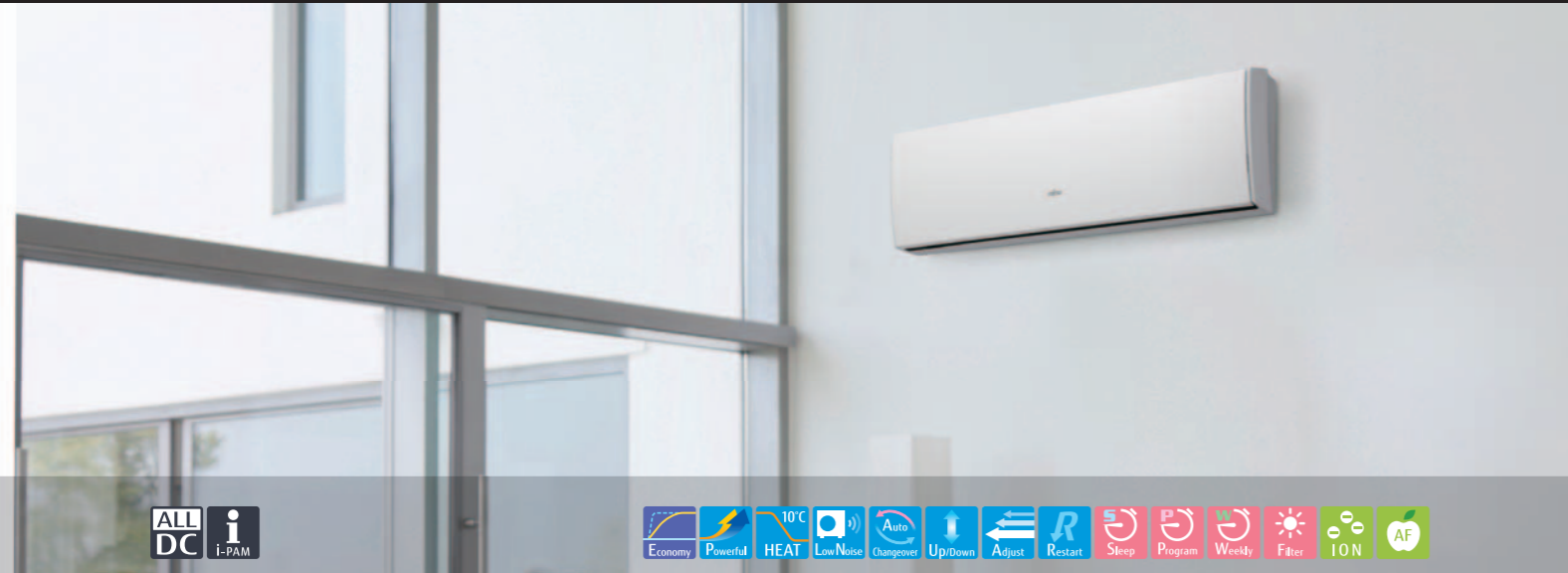

Features

Thin & Slim design

Thin and slim design is realized by Ø5-mm heat exchanger and high efficiency wind blower.

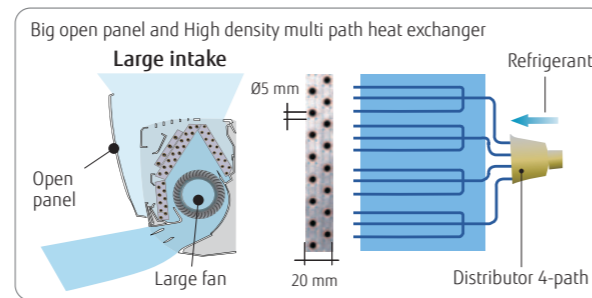

Powerful operation

20 minutes continuous operation by maximum airflow and maximum compressor speed is possible. Rapid cooling and heating makes the room comfortable quickly.

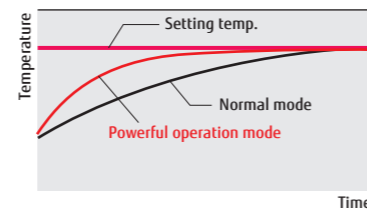

3 Mode timer (Weekly/Program/Sleep)

Weekly timer can be easily set by wireless remote controller. ON, OFF can be set up to 4 times in 1 day and up to 28 times in 1 week. For other modes, program timer and sleep timer can be also selected by one push.



10°C HEAT Operation

The room temperature can be set to go no lower than 10°C, thus ensuring that the room does not get too cold when not occupied. *Only available with Wireless RC.

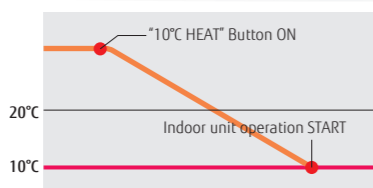

Low ambient operation

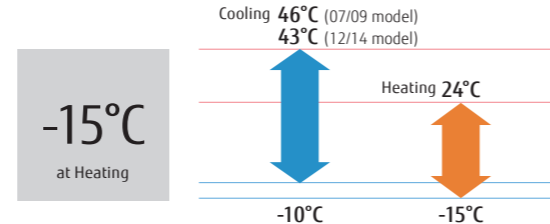

Model: ASYG07LUCA / ASYG09LUCA / ASYG12LUCA / ASYG14LUCA



Wireless R.C.



For ASYG07/09LUCA



For ASYG12/14LUCA

Specifications

Model No.	Indoor unit		ASYG07LUCA	ASYG09LUCA	ASYG12LUCA	ASYG14LUCA
	Outdoor unit		AOYG07LUCB	AOYG09LUCB	AOYG12LUC	AOYG14LUC
Power Source	Single-phase, ~230V, 50Hz					
Capacity	Cooling	kW	2.0 (0.5-3.0)	2.5 (0.5-3.2)	3.5 (0.9-4.0)	4.2 (0.9-5.0)
	Heating	kW	3.0 (0.5-4.0)	3.2 (0.5-4.2)	4.0 (0.9-5.4)	5.4 (0.9-6.0)
Input Power	Cooling/Heating		0.460/0.660	0.555/0.680	0.905/0.930	1.235/1.380
EER	Cooling	W/W	4.35	4.50	3.87	3.40
	Heating	W/W	4.55	4.71	4.30	3.91
Pdesign	Cooling/Heating(-10°C)		2.0/2.6	2.5/2.8	3.5/3.9	4.2/4.8
SEER	Cooling	W/W	7.20	7.10	7.05	6.78
	Heating (Average)	W/W	4.10	4.10	4.00	4.00
Energy Efficiency Class	Cooling		A++	A++	A++	A++
	Heating (Average)		A+	A+	A+	A+
Max. Operating Current	Cooling/Heating	A	6.0/7.5	6.0/7.5	6.5/9.0	9.0/10.5
	Cooling	kWh/a	97	123	174	217
Annual Energy Consumption	Heating	kWh/a	887	956	1363	1677
	Moisture Removal	l/h	1.0	1.3	1.8	2.1
Sound Pressure Level	Indoor (Cooling)	H/M/L/Q	38/35/31/21	42/36/32/21	43/37/32/21	45/40/33/25
	Indoor (Heating)	H/M/L/Q	38/35/31/21	42/37/32/21	43/38/32/21	45/40/34/27
Sound Power Level	Outdoor(Cooling/Heating)	High	46/46	48/48	50/50	50/50
	Indoor(Cooling/Heating)	High	57/59	59/61	60/62	60/64
Airflow Rate	Outdoor(Cooling/Heating)	High	58/58	60/60	65/65	65/65
	Indoor / Outdoor	High	680/1,720	800/1,720	850/1,940	900/1,940
Net Dimensions H x W x D	Indoor	mm	282*870*185	282*870*185	282*870*185	282*870*185
	Outdoor	mm	540*660*290	540*660*290	540*790*290	540*790*290
Weight	Indoor	kg(lbs)	9.5 (21)	9.5 (21)	9.5 (21)	9.5 (21)
	Outdoor	kg(lbs)	23 (51)	25 (55)	33 (73)	34 (75)
Connection Pipe Diameter (Liquid / Gas)			6.35/9.52	6.35/9.52	6.35/9.52	6.35/12.7
Drain hose Diameter (I.D./O.D.)			13.8/15.8 to 16.7	13.8/15.8 to 16.7	13.8/15.8 to 16.7	13.8/15.8 to 16.7
Max Pipe Length (Pre-Charge)			20 (15)	20 (15)	20 (15)	20 (15)
Max Height Difference			15	15	15	15
Operation Range	Cooling	*CDB	-10 to 46	-10 to 46	-10 to 43	-10 to 43
	Heating	*CDB	-15 to 24	-15 to 24	-15 to 24	-15 to 24
Refrigerant	Type (Global Warming Potential)		R410A (2,088)	R410A (2,088)	R410A (2,088)	R410A (2,088)
	Charge	g	700	850	1,050	1,050

Optional parts

- Wired Remote Controller: UTY-RNNYM, UTY-RVNYM
- Simple Remote Controller: UTY-RSNYM
- Communication kit: UTY-TWBXF

Dimensions

(Unit : mm)

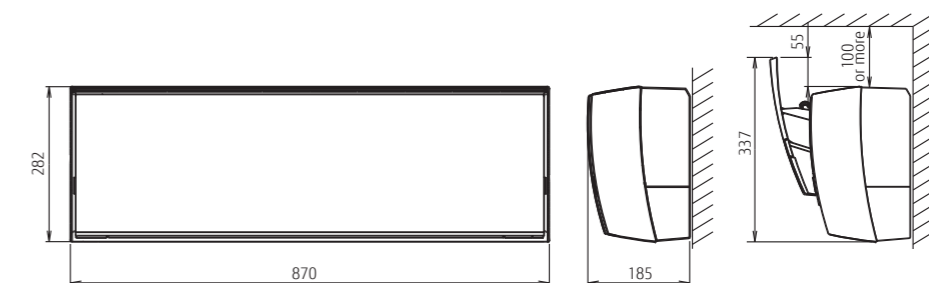

Wall Mounted Standard Range High Efficiency & Comfort

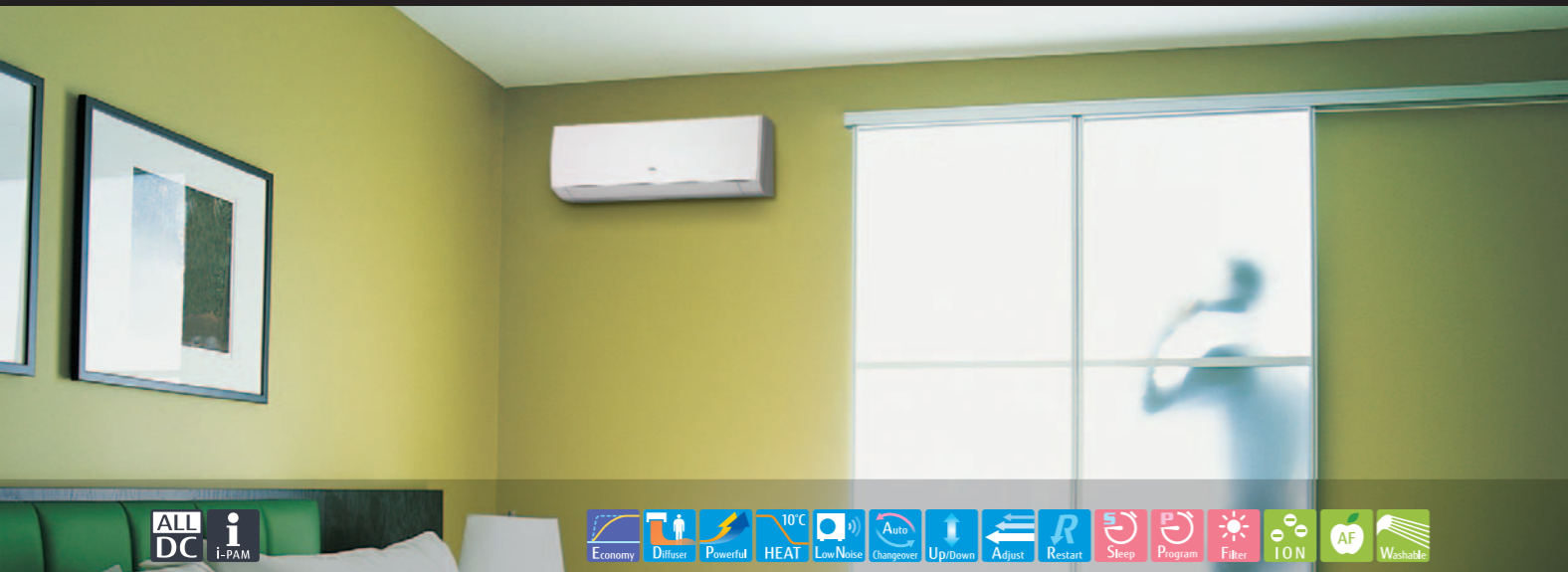

Features

High efficient compact design

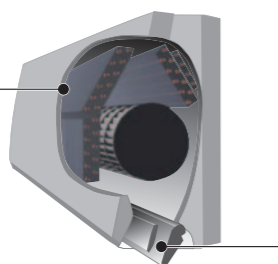
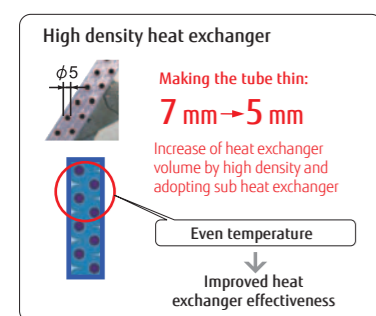

More comfort airflow

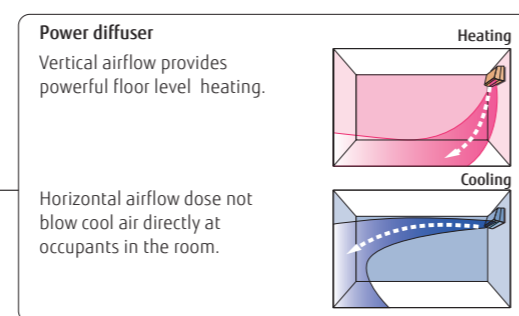

Powerful operation

20 minutes continuous operation by maximum airflow and maximum compressor speed is possible. Rapid cooling and heating makes the room comfortable quickly.

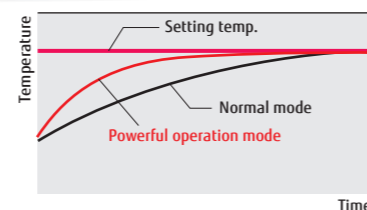

10°C HEAT Operation

The room temperature can be set to go no lower than 10°C, thus ensuring that the room does not get too cold when not occupied

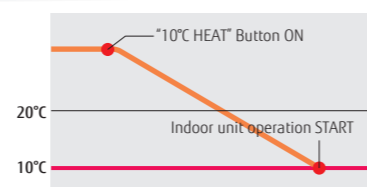

Low noise mode for outdoor unit

Low noise mode of outdoor unit can be selected by wireless remote controller.

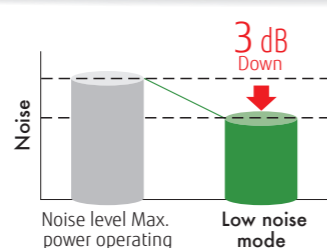

Low ambient operation

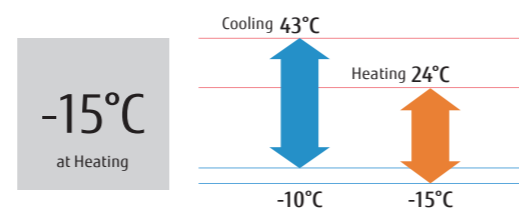

Model: ASYG07LMCA / ASYG09LMCA / ASYG12LMCA / ASYG14LMCA



Wireless R.C.



For ASYG07/09/12LMCA



For ASYG14LMCA

Specifications

Model No.	Indoor unit		ASYG07LMCA	ASYG09LMCA	ASYG12LMCA	ASYG14LMCA		
	Outdoor unit		AOYG07LMCA	AOYG09LMCA	AOYG12LMCA	AOYG14LMCA		
Power Source			Single-phase, ~230V, 50Hz					
Capacity	Cooling	kW	2.0 (0.5-3.0)	2.5 (0.5-3.2)	3.4 (0.9-3.9)	4.0 (0.9-4.4)		
	Heating		3.0 (0.5-3.4)	3.2 (0.5-4.0)	4.0 (0.9-5.3)	5.0 (0.9-6.0)		
Input Power	Cooling/Heating	kW	0.465/0.685	0.65/0.73	0.97/1.02	1.135/1.365		
EER	Cooling	W/W	4.30	3.85	3.50	3.52		
COP	Heating		4.38	4.38	3.92	3.66		
Pdesign	Cooling/Heating(-10°C)	kW	2.0/2.3	2.5/2.4	3.4/3.5	4.0/3.9		
SEER	Cooling	W/W	6.80	7.00	7.00	6.90		
SCOP	Heating (Average)		4.10	4.10	4.00	4.00		
Energy Efficiency Class	Cooling		A++	A++	A++	A++		
	Heating (Average)		A+	A+	A+	A+		
Max. Operating Current	Cooling/Heating	A	6.0/7.5	6.0/7.5	6.5/9.0	9.0/10.5		
Annual Energy Consumption	Cooling	kWh/a	103	125	170	203		
	Heating		786	820	1225	1365		
Moisture Removal		l/h	1.0	1.3	1.8	2.1		
Sound Pressure Level	Indoor (Cooling)	H/M/L/Q	43/40/32/21					
	Indoor (Heating)		43/38/33/22					
Sound Power Level	Outdoor(Cooling/Heating)	High	dB(A)		45/45	45/45	50/50	50/50
	Indoor(Cooling/Heating)		High	59/59	59/59	59/59	60/60	
Airflow Rate	Indoor / Outdoor	High	m³/h		750/1670	750/1670	750/1830	750/1800
	Net Dimensions		Indoor	mm		268×840×203	268×840×203	268×840×203
Weight	Outdoor	kg(lbs)		8.5 (19)	8.5 (19)	8.5 (19)	8.5 (19)	
		mm		535×663×293	535×663×293	535×663×293	540×790×290	
Connection Pipe Diameter (Liquid / Gas)			mm		6.35/9.52	6.35/9.52	6.35/9.52	6.35/12.7
			mm		13.8/15.8 to 16.7	13.8/15.8 to 16.7	13.8/15.8 to 16.7	13.8/15.8 to 16.7
Drain hose Diameter (I.D./O.D.)			mm		20 (15)	20 (15)	20 (15)	20 (15)
Max Pipe Length (Pre-Charge)			m		15	15	15	15
Operation Range	Cooling	°CDB	-10 to 43					
	Heating		-15 to 24					
Refrigerant	Type (Global Warming Potential)	R410A (2,088)						
	Charge	g	700	700	850	1,050		

Optional parts

Wired Remote Controller: UTY-RNNYM, UTY-RVNYM

Simple Remote Controller: UTY-RSNYM

Communication kit: UTY-XCBX22

Dimensions

(Unit : mm)

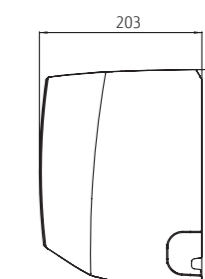
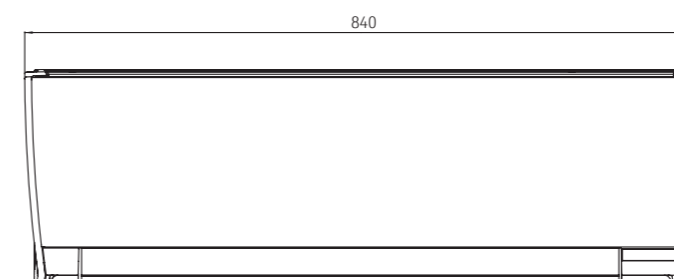



Features

Large Capacity & Powerful airflow

Achieved large capacity and powerful airflow by large heat exchanger, long cross-flow fan, high output DC fan motor and new airflow structure design.



Human sensor

Human sensor catches movements of people in a room, and operates with lower capacity when people leave the room. When people come back to the room, it automatically returns to previous operating mode.



Server room function*

The following interlock operation is possible by connecting 2 indoor units with a cable. Cooling operation can be performed even in the low outdoor temperature and low humidity environment.

- **Alternative operation:** Two units operate alternately
- **Backup operation:** When 1 unit breaks down, the other unit starts operating automatically.
- **Supporting operation:** Both units operate simultaneously when the loaded capacity is not enough with one unit

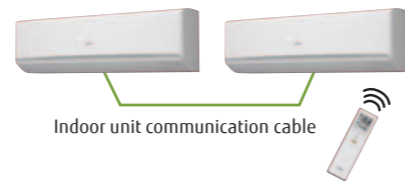

High seasonal energy efficiency

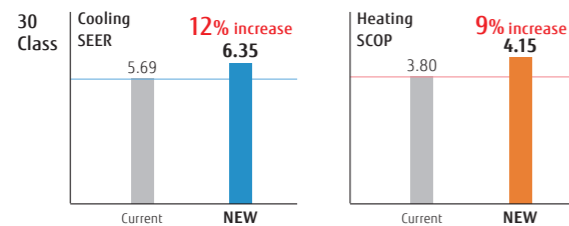

Low ambient operation

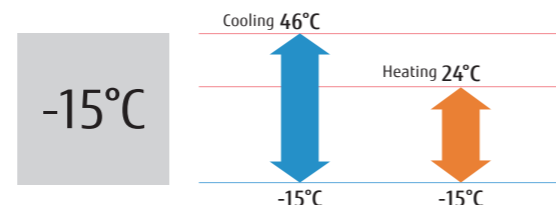

Model: ASYG30LMTA / ASYG36LMTA



Wireless R.C.



Specifications

Model No.	Indoor unit		Outdoor unit		ASYG30LMTA	ASYG36LMTA	
					AOYG30LMTA	AOYG36LMTA	
Power Source	Single-phase, ~230V, 50Hz						
Capacity	Cooling	kW			8.0 (2.9-9.0)	9.4 (2.9-10.0)	
	Heating				8.8 (2.2-11.0)	10.1 (2.7-11.2)	
Input Power	Cooling/Heating	kW			2.33/2.41	3.16/2.96	
EER	Cooling				3.43	2.97	
	Heating	W/W			3.65	3.41	
Pdesign	Cooling/Heating(-10°C)				8.0/6.5	9.4/7.1	
SEER	Cooling	W/W			6.35	5.73	
SCOP	Heating (Average)				4.15	4.19	
Energy Efficiency Class	Cooling			A++	A+		
	Heating (Average)			A+	A+		
Max. Operating Current	Cooling/Heating	A			14.5/14.5	19.0/19.0	
Annual Energy Consumption	Cooling				441	575	
	Heating	kWh/a			2,193	2,373	
Moisture Removal					2.7	3.7	
Sound Pressure Level	Indoor (Cooling)	H/M/L/Q			50/44/38/31	50/44/38/31	
	Indoor (Heating)	H/M/L/Q			49/44/39/33	49/44/39/33	
	Outdoor(Cooling/Heating)	High	dB(A)			52/55	55/56
Sound Power Level	Indoor(Cooling/Heating)	High				65/65	65/65
	Outdoor(Cooling/Heating)	High			67/68	68/70	
Airflow Rate	Indoor / Outdoor	High	m³/h			1380/3600	1380/3800
Net Dimensions H x W x D	Indoor					340×1150×280	340×1150×280
	Weight	Outdoor				61 (134)	61 (134)
Connection Pipe Diameter (Liquid / Gas)			mm			9.52/15.88	9.52/15.88
Drain hose Diameter (I.D./O.D.)						13.8 / 15.8 to 16.7	13.8 / 15.8 to 16.7
Max Pipe Length (Pre-Charge)			m			50 (20)	50 (20)
Max Height Difference						30	30
Operation Range	Cooling	°CDB			-15 to 46	-15 to 46	
	Heating				-15 to 24	-15 to 24	
Refrigerant	Type (Global Warming Potential)					R410A (2,088)	R410A (2,088)
	Charge	g					2,100

Optional parts

- Wired Remote Controller (Touch panel (two-wire)): UTY-RNRYZ1 + UTY-TWRX
- Wired Remote Controller (High grade (three-wire)): UTY-RVNYM + UTY-XWNX
- Wired Remote Controller (two-wire): UTY-RLRY + UTY-TWRX
- Wired Remote Controller(three-wire): UTY-RNNYM + UTY-XWNX
- Simple Remote Controller (three-wire): UTY-RSNYM + UTY-XWNX
- External input and output PCB (with box): UTY-XCSXZ1 + UTZ-GXXB
- External Connect Kit: UTY-XWZX

Dimensions

(Unit : mm)

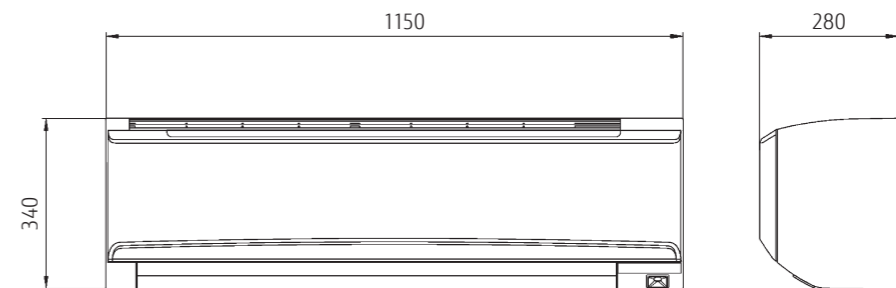

Wall Mounted Standard Range Comfort for Large Room

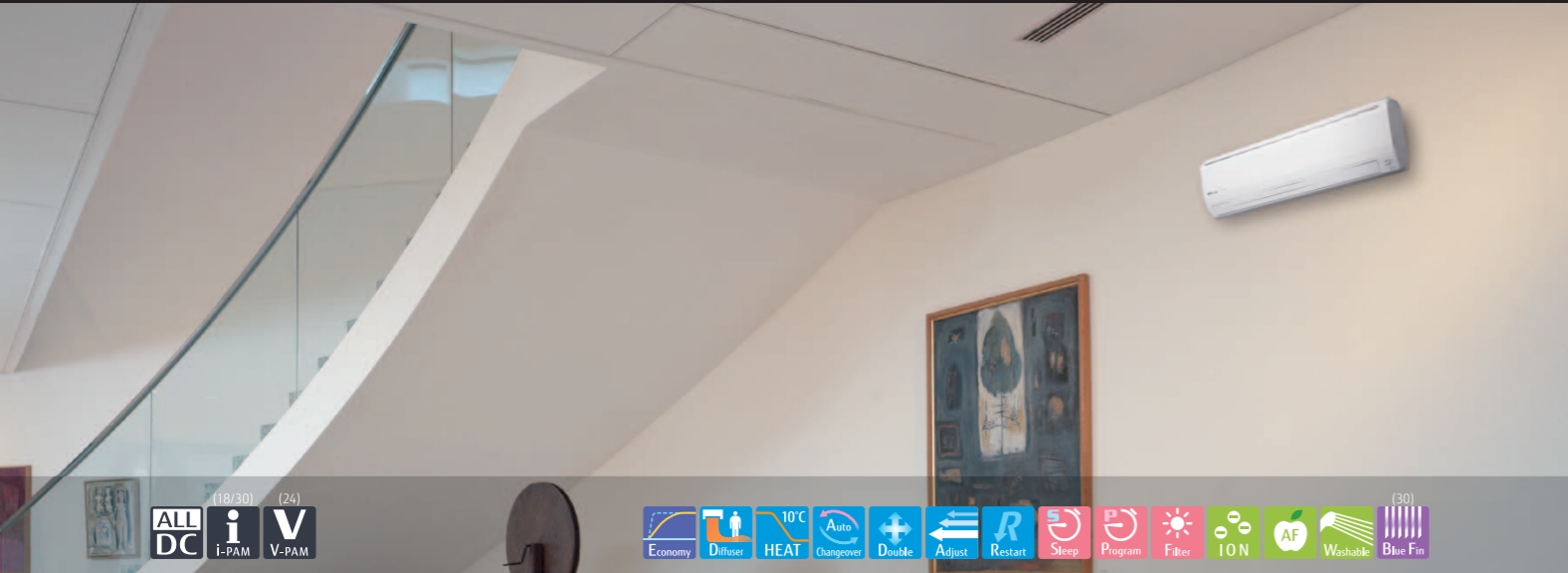

Features

"Vertical airflow" provides powerful floor level heating

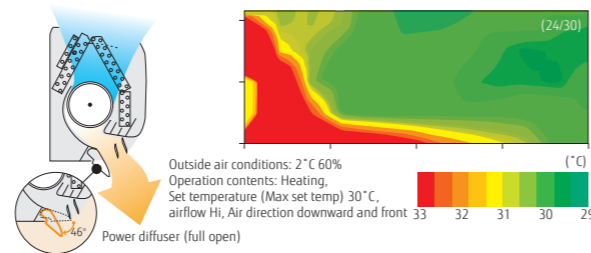

"Horizontal airflow" does not blow cool air directly at the occupants in the room

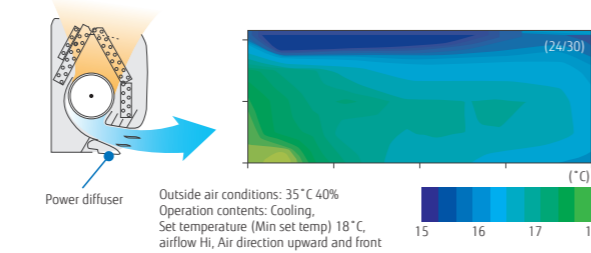

Air conditioner filter features

Ion Deodorization Filter
The filter deodorizes by powerfully decomposing absorbed odors using the oxidizing and reducing effects of ions generated by the ultra-fine-particle ceramic.

Using different filters at both sides

Apple-catechin Filter
The Apple-catechin filter uses static electricity to clean fine particles and dust in the air.

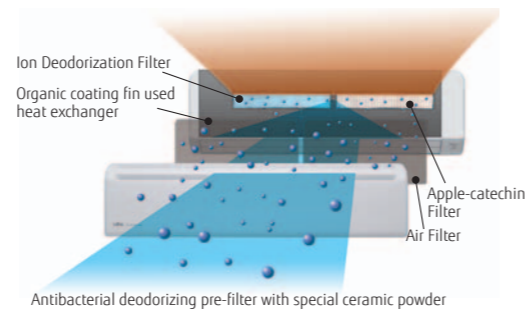

Flexible Installation

	18 type	24 type	30 type
Max. Piping Length	25 m	30 m	50 m
Max. Height	20 m	20 m	30 m

Low ambient operation

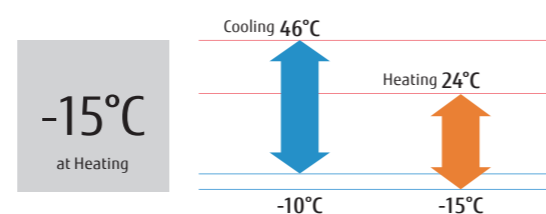

Model: ASYG18LFCA / ASYG24LFCC / ASYG30LFCA



Wireless R.C.



For ASYG18LFCA, ASYG24LFCC



For ASYG30LFCA

Specifications

Model No.	Indoor unit		ASYG18LFCA	ASYG24LFCC	ASYG30LFCA
	Outdoor unit		AOYG18LFC	AOYG24LFC	AOYG30LFT
Power Source	Single-phase, ~230V, 50Hz				
Capacity	Cooling	kW	5.2 (0.9-6.0)	7.1 (0.9-8.0)	8.0 (2.9-9.0)
	Heating		6.3 (0.9-9.1)	8.0 (0.9-10.6)	8.8 (2.2-11.0)
Input Power	Cooling/Heating		1.52/1.71	2.20/2.21	2.49/2.44
	Cooling	W/W	3.42	3.23	3.21
COP	Heating		3.68	3.61	3.61
	Pdesign	Cooling/Heating(-10°C)		5.2/5.9	7.1/7.1
SEER		Cooling		6.94	6.11
	SCOP	Heating (Average)		3.87	3.80
Energy Efficiency Class		Cooling		A++	A++
	Heating (Average)		A	A	A
Max. Operating Current	Cooling/Heating		9.0/12.5	13.5/18.5	17.0/19.0
	Annual Energy Consumption		kWh/a	262	406
Moisture Removal	Cooling		2130	2610	2941
	Heating		2.6	2.7	3.2
Sound Pressure Level	Indoor (Cooling)	H/M/L/Q	43/37/33/26	49/42/37/32	48/42/37/33
	Indoor (Heating)		42/37/33/25	48/42/37/32	49/42/37/33
Sound Power Level	Outdoor(Cooling/Heating)	High	50/51	55/56	53/56
	Indoor(Cooling/Heating)		58/58	64/64	64/64
Airflow Rate	Indoor / Outdoor	High	65/-	68/-	68/-
	m³/h		900/2150	1120/2460	1100/3600
Net Dimensions H x W x D	Indoor		mm	320×998×238	320×998×238
	Outdoor		kg(lbs)	14 (31)	14 (31)
Weight	Indoor		mm	620×790×290	620×790×290
	Outdoor		kg(lbs)	41 (90)	41 (90)
Connection Pipe Diameter (Liquid / Gas)	Indoor		mm	6.35/12.7	6.35/15.88
	Outdoor		mm	12/16	12/16
Drain hose Diameter (I.D./O.D.)	Indoor		m	25 (15)	30 (15)
Max Pipe Length (Pre-Charge)	Indoor		m	20	20
Max Height Difference	Indoor		°CDB	-10 to 46	-10 to 46
Operation Range	Cooling		°CDB	-15 to 24	-15 to 24
	Heating		g	1,200	1,800
Refrigerant	Type (Global Warming Potential)			R410A (2,088)	R410A (2,088)
	Charge			2,100	

Optional parts

Wired Remote Controller: UTY-RNNYM, UTY-RVNYM

Simple Remote Controller: UTY-RSNYM

Dimensions

(Unit : mm)

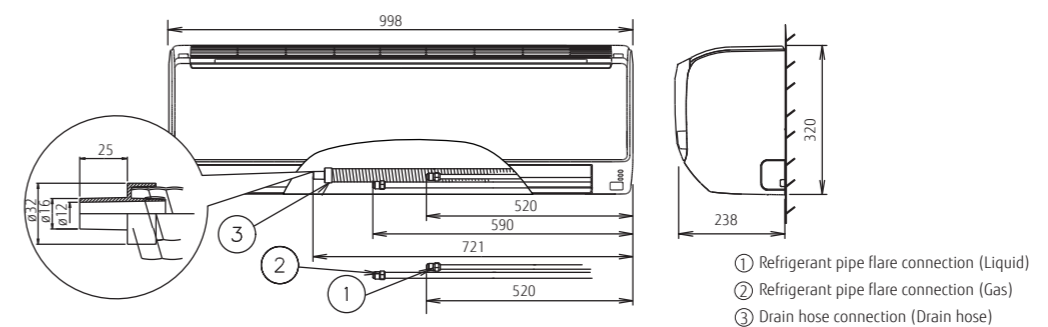

Wall Mounted ECO Range Compact & Comfort



Model: ASYG07LLCC / ASYG09LLCC / ASYG12LLCC



Wireless R.C.



Specifications

Model No.	Indoor unit		ASYG07LLCC	ASYG09LLCC	ASYG12LLCC
	Outdoor unit		AOYG07LLCC	AOYG09LLCC	AOYG12LLCC
Power Source	Single-phase, ~230V, 50Hz				
Capacity	Cooling	kW	2.0 (0.9-2.8)	2.5 (0.9-3.0)	3.4 (0.9-3.8)
	Heating	kW	2.7 (0.9-3.6)	3.0 (0.9-3.8)	4.0 (0.9-5.0)
Input Power	Cooling/Heating		0.470/0.620	0.730/0.740	1.080/1.130
EER	Cooling	W/W	4.26	3.42	3.15
	Heating	W/W	4.35	4.05	3.54
Pdesign	Cooling/Heating(-10°C)		2.0/2.2	2.5/2.3	3.4/3.2
SEER	Cooling		6.70	6.90	6.60
SCOP	Heating (Average)		4.00	4.00	3.80
Energy Efficiency Class	Cooling		A++	A++	A++
	Heating (Average)		A+	A+	A
Max. Operating Current	Cooling/Heating		6.0/7.5	6.0/7.5	6.5/9.0
Annual Energy Consumption	Cooling		104	127	180
	Heating		770	805	1,179
Moisture Removal			1.0	1.3	1.8
Sound Pressure Level	Indoor (Cooling)	H/M/L/Q	43/38/33/22	43/38/33/22	43/38/33/22
	Indoor (Heating)	H/M/L/Q	43/38/33/22	43/38/33/22	43/38/33/22
	Outdoor (Cooling/Heating)	High	47/48	47/48	50/51
Sound Power Level	Indoor (Cooling/Heating)	High	59/60	59/60	59/60
	Outdoor (Cooling/Heating)	High	61/61	61/61	65/65
	Airflow Rate	Indoor / Outdoor	High	720/1,670	720/1,670
Net Dimensions H x W x D	Indoor		mm	262*820*206	262*820*206
	Outdoor		kg(lbs)	7.0 (15)	7.0 (15)
Weight	Indoor		mm	535*663*293	535*663*293
	Outdoor		kg(lbs)	24 (53)	24 (53)
Connection Pipe Diameter (Liquid / Gas)			mm	6.35/9.52	6.35/9.52
Drain hose Diameter (I.D./O.D.)			mm	13.8/15.8 to 16.7	13.8/15.8 to 16.7
Max Pipe Length (Pre-Charge)			m	20 (15)	20 (15)
Max Height Difference			m	15	15
Operation Range	Cooling		°CDB	-10 to 43	-10 to 43
	Heating		°CDB	-15 to 24	-15 to 24
Refrigerant	Type (Global Warming Potential)			R410A (2,088)	R410A (2,088)
	Charge		g	650	650

Features

High efficient compact design

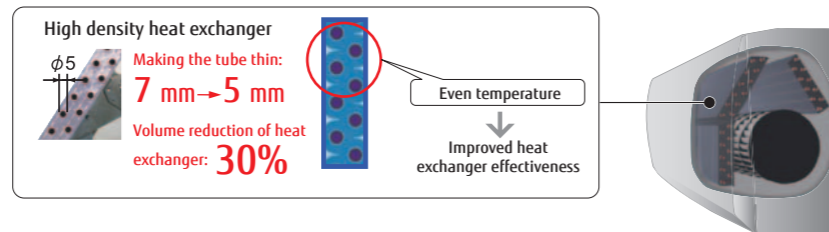

ON-OFF Programmable timer

You can set an integrated ON-OFF or OFF-ON timer suitable for your life style. (Setting time: 0.5, 1, 1.5, 2, 2.5, -----9.5, 10, 11, 12 hours)

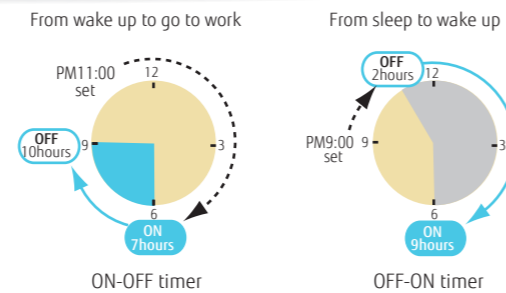

Powerful operation

20 minutes continuous operation by maximum airflow and maximum compressor speed is possible. Rapid cooling and heating makes the room comfortable quickly.

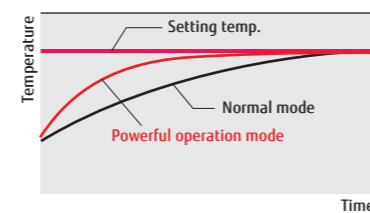

Economy operation

Setting temp. is shifted by 1°C automatically.

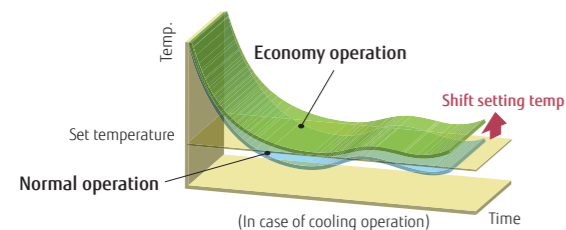

Low ambient operation

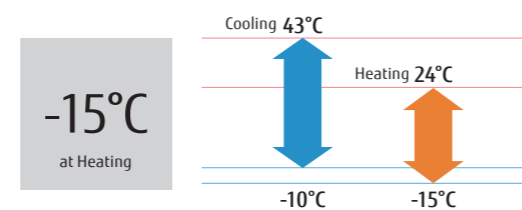

Optional parts

Remote Controller Holder: UTZ-RXLA

Dimensions

(Unit : mm)

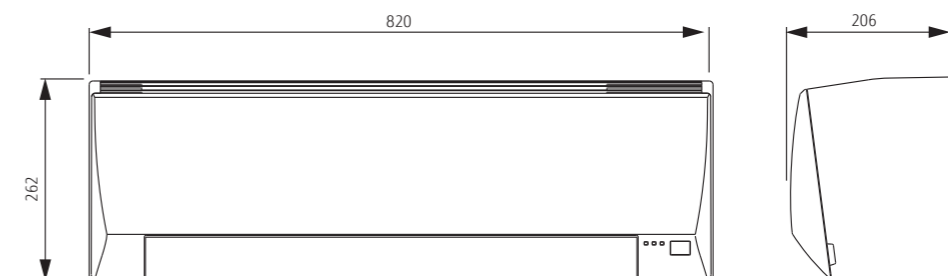

Floor Compact & Comfort



Features

2-Fan & Wide airflow

Individual vertical airflow by 2-fan can control the whole room comfortably.

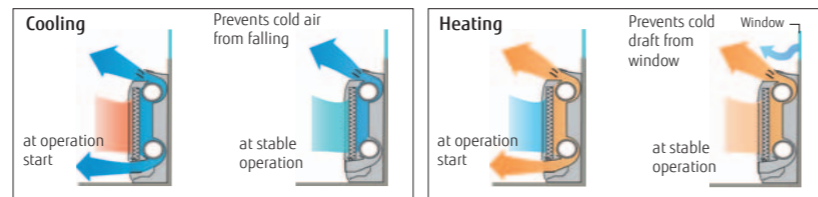

Flexible & easy installation

Due to compact and whole surface suction method model, floor, concealed, half concealed, or wall mounted installation can be available to match the room layout.

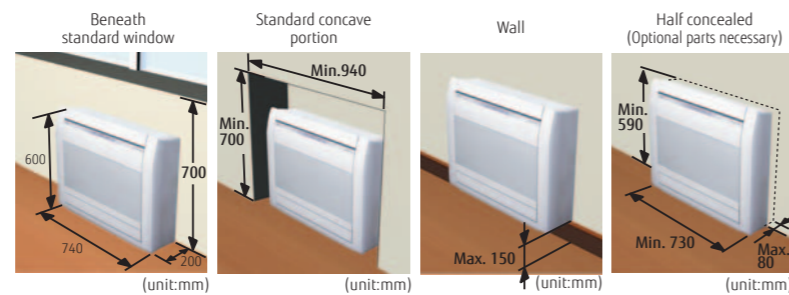

Flexible piping connection 6 direction of drain & piping

Drain hose and piping can be drawn flexibly in the right, left, side, and down directions

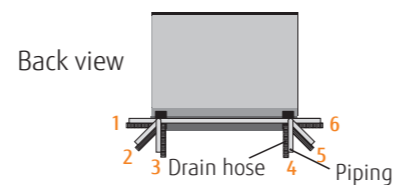

10°C HEAT Operation

The room temperature can be set to go no lower than 10°C, thus ensuring that the room does not get too cold when not occupied

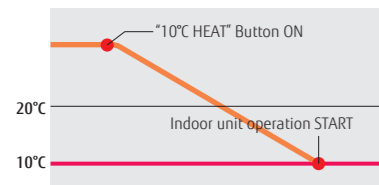

Low ambient operation

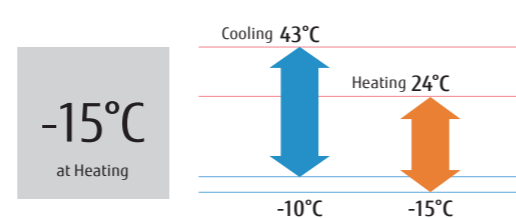

Model: AGYG09LVCA / AGYG12LVCA / AGYG14LVCA



Wireless R.C.



For AGYG09/12LVCA



For AGYG14LVCA

Specifications

Model No.	Indoor unit		AGYG09LVCA	AGYG12LVCA	AGYG14LVCA
	Outdoor unit		AOYG09LVCA	AOYG12LVCA	AOYG14LVCA
Power Source	Single-phase, ~230V, 50Hz				
Capacity	Cooling	kW	2.6 (0.9-3.5)	3.5 (0.9-4.0)	4.2 (0.9-5.0)
	Heating		3.5 (0.9-5.5)	4.5 (0.9-6.6)	5.2 (0.9-8.0)
Input Power	Cooling/Heating	kW	0.53/0.79	0.94/1.19	1.14/1.44
EER	Cooling	W/W	4.91	3.72	3.68
COP	Heating		4.43	3.78	3.61
Pdesign	Cooling/Heating(-10°C)	kW	2.6/2.9	3.5/3.8	4.2/4.7
SEER	Cooling	W/W	7.00	6.50	6.40
SCOP	Heating (Average)		4.20	4.00	4.00
Energy Efficiency Class	Cooling	A	A++	A++	A++
	Heating (Average)		A+	A+	A+
Max. Operating Current	Cooling/Heating	A	7.0/10.0	7.0/10.0	9.0/13.5
Annual Energy Consumption	Cooling	kWh/a	130	188	230
	Heating		967	1330	1645
Moisture Removal		l/h	1.3	1.8	2.1
Sound Pressure Level	Indoor (Cooling)	H/M/L/Q	40/35/29/22	40/35/29/22	44/38/31/22
	Indoor (Heating)	H/M/L/Q	40/35/29/22	40/35/29/22	43/37/29/22
	Outdoor(Cooling/Heating)	High	47/48	48/49	50/50
Sound Power Level	Indoor(Cooling/Heating)	High	55/56	55/56	58/58
	Outdoor(Cooling/Heating)	High	64/65	64/65	65/66
Airflow Rate	Indoor / Outdoor	High	m³/h	570/1680	570/1680
Net Dimensions H x W x D	Indoor	kg(lbs)	600×740×200	600×740×200	600×740×200
	Outdoor		14 (31)	14 (31)	14 (31)
Weight	Indoor	kg(lbs)	540×790×290	540×790×290	578×790×300
	Outdoor		36 (79)	36 (79)	40 (88)
Connection Pipe Diameter (Liquid / Gas)		mm	6.35/9.52	6.35/9.52	6.35/12.7
Drain hose Diameter (I.D./O.D.)		mm	13.8/15.8 to 16.7	13.8/15.8 to 16.7	13.8/15.8 to 16.7
Max Pipe Length (Pre-Charge)		m	20 (15)	20 (15)	20 (15)
Max Height Difference		m	15	15	15
Operation Range	Cooling	°CDB	-10 to 43	-10 to 43	-10 to 43
	Heating		-15 to 24	-15 to 24	-15 to 24
Refrigerant	Type (Global Warming Potential)		R410A (2,088)	R410A (2,088)	R410A (2,088)
	Charge	g	1,050	1,050	1,150

Optional parts

Wired Remote Controller: UTY-RNNYM, UTY-RVNYM

Simple Remote Controller: UTY-RSNYM

Half Concealed Kit: UTR-STA

Dimensions

(Unit : mm)

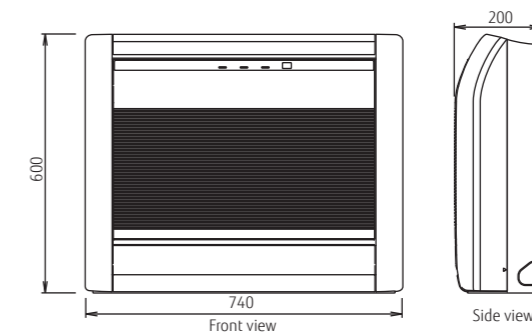

Floor/Ceiling Comfort & Dual Design

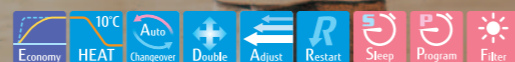

Model : ABYG18LVTB / ABYG24LVTA



Wireless R.C.



For ABYG18LVTB



For ABYG24LVTA

Specifications

Model No.	Indoor unit		ABYG18LVTB		ABYG24LVTA	
	Outdoor unit		AOYG18LALL		AOYG24LALA	
Power Source	Single-phase, ~230V, 50Hz					
Capacity	Cooling	kW	5.2 (0.9-5.9)		6.8 (0.9-8.0)	
	Heating	kW	6.0 (0.9-7.5)		8.0 (0.9-9.1)	
Input Power	Cooling/Heating		1.62/1.66		2.21/2.26	
	EER	Cooling	3.21		3.08	
COP		Heating	3.61		3.54	
	Pdesign	Cooling/Heating(-10°C)		5.2/5.2		6.8/6.0
SEER		Cooling	6.10		5.60	
	SCOP	Heating (Average)		4.00		3.90
Energy Efficiency Class		Cooling	A++		A+	
	Max. Operating Current	Heating (Average)		A+		A
Annual Energy Consumption		Cooling/Heating	A		12.0/13.5	
	Moisture Removal	Cooling	298		425	
Sound Pressure Level		Heating	1819		2150	
	Sound Power Level	Cooling	2.0		2.7	
Airflow Rate		Indoor (Cooling)	H/M/L/Q	43/40/34/31		48/44/40/35
	Net Dimensions	Indoor (Heating)	H/M/L/Q	43/40/34/31		48/44/40/35
Weight		Outdoor(Cooling/Heating)	High	50/50		52/53
	Connection Pipe Diameter (Liquid / Gas)	Indoor(Cooling/Heating)	High	57/57		61/61
Drain hose Diameter (I.D./O.D.)		Outdoor(Cooling/Heating)	High	62/65		67/70
	Max Pipe Length (Pre-Charge)	Indoor / Outdoor	High	780/2000		980/2470
Max Height Difference		Indoor	mm	199×990×655		199×990×655
	Operation Range	H x W x D	kg(lbs)	27 (59)		27 (59)
Refrigerant		Outdoor	mm	578×790×300		578×790×315
	Type (Global Warming Potential)	kg(lbs)	mm	40 (88)		44 (97)
Charge		g	mm	6.35/12.70		6.35/15.88
	Max Pipe Length (Pre-Charge)	mm	mm	25/32		25/32
Max Height Difference		m	m	25 (15)		30 (15)
	Operation Range	Cooling	°CDB	-10 to 46		-10 to 46
Refrigerant		Heating	°CDB	-15 to 24		-15 to 24
	Type (Global Warming Potential)	g	g	1,250		1,700
Charge		g	g	1,250		1,700

Features

Flexible installation

Example for floor installation

Floor console



Example for ceiling installation

Under ceiling



Double auto swing

A combination of right/left and up/down directional swing allows 3-dimensional air direction control

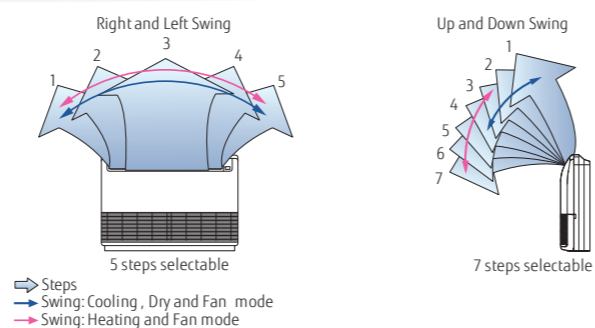

High power DC fan motor

- High power
- Wide rotation range
- High efficiency

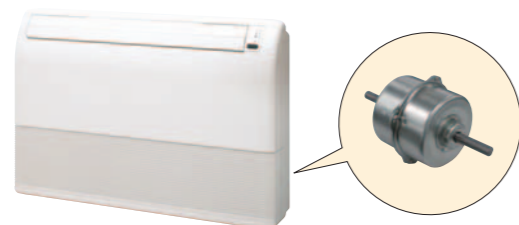

Low ambient operation

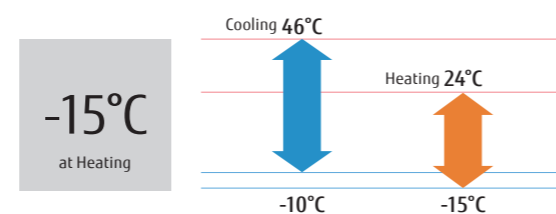

Optional parts

Wired Remote Controller: UTY-RNNYM, UTY-RVNYM

Simple Remote Controller: UTY-RSNYM

Dimensions

(Unit : mm)

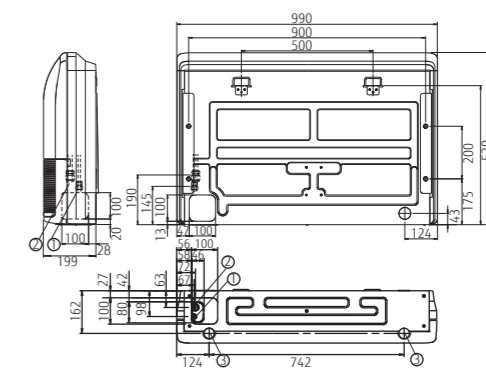

Ceiling Comfort for Large Room

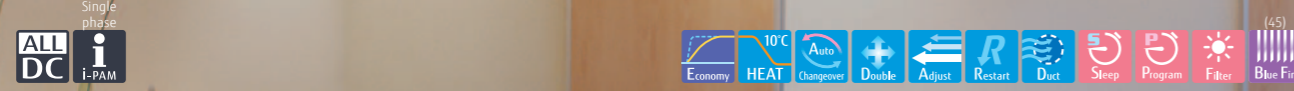

Features

Flexible installation

Various installations are possible to match the room layout.

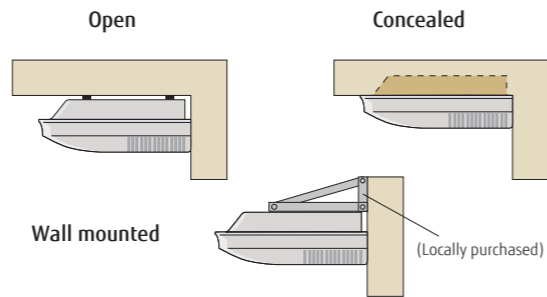

Multi auto swing

A combination of right/left and up/down directional swing allows 3-dimensional air direction control.

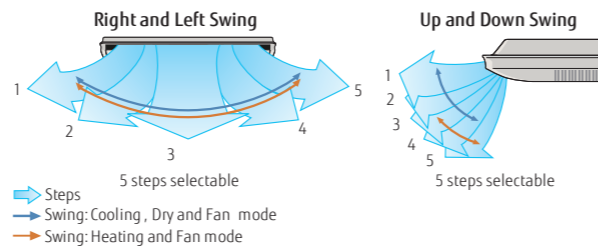

Fresh air intake

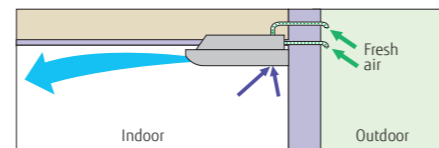

Low ambient operation

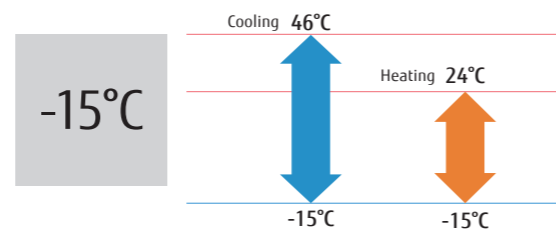

Model : **ABYG30LRTE / AYG36LRTE / AYG45LRTA / AYG36LRTA [3phase] / AYG45LRTA [3phase] / AYG54LRTA [3phase]**



Wireless R.C.



For AYG30/36LRTE



For AYG36/45/54LRTA

Specifications

Model No.	Indoor unit			Outdoor unit				
	ABYG30LRTE	ABYG36LRTE	ABYG45LRTA	AOYG30LETL	AOYG36LETL	AOYG45LETL		
Power Source	Single-phase, ~230V, 50Hz			3-phase, ~400V, 50Hz				
Capacity	Cooling	8.5 (2.8-10.0)	9.4 (2.8-11.2)	12.1 (4.0-13.3)	10.0 (4.7-11.4)	12.5 (5.0-14.0)	14.0 (5.4-16.0)	
	Heating	10.0 (2.7-11.2)	11.2 (2.7-12.7)	13.3 (4.2-15.5)	11.2 (5.0-14.0)	14.0 (5.4-16.2)	16.0 (5.8-18.0)	
Input Power	Cooling/Heating	2.65/2.77	2.93/3.02	3.77/3.68	2.84/2.87	3.89/3.88	4.65/4.67	
EER	Cooling	3.21	3.21	3.21	3.52	3.21	3.01	
	Heating	3.61	3.71	3.61	3.90	3.61	3.43	
COP	Cooling/Heating(-10°C)	8.5/8.0	9.4/8.7	-	10.0/10.0	-	-	
Pdesign	Cooling	6.10	6.00	-	6.10	-	-	
SEER	Heating	4.20	4.10	-	4.10	-	-	
SCOP	Cooling	A++	A+	-	A++	-	-	
Energy Efficiency Class	Heating	A+	A+	-	A+	-	-	
Max. Operating Current	Cooling/Heating	17.0/17.0	18.5/20.0	20.5/20.5	7.9/7.9	8.9/8.9	9.9/9.9	
Annual Energy Consumption	Cooling	487	548	-	573	-	-	
	Heating	2662	2965	-	3414	-	-	
Moisture Removal		2.5	3.0	4.0	3.0	4.5	5.0	
Sound Pressure Level	Indoor (Cooling)	H/M/L/Q	45/43/37/32	47/43/37/32	49/45/39/34	47/43/37/32	49/45/39/34	51/48/42/38
	Indoor (Heating)	H/M/L/Q	45/43/37/32	47/43/37/32	49/45/39/34	47/43/37/32	49/45/39/34	51/48/42/38
Sound Power Level	Outdoor (Cooling/Heating)	High	53/55	54/55	55/55	51/53	54/54	55/56
	Indoor (Cooling/Heating)	High	57/60	60/61	-	61/61	-	-
Airflow Rate	Outdoor (Cooling/Heating)	High	68/69	69/70	-	67/69	-	-
	Indoor / Outdoor	High	1660/3600	1900/3800	2100/6200	1900/6200	2100/6900	2300/6900
Net Dimensions H x W x D	Indoor	mm	240×1660×700	240×1660×700	240×1660×700	240×1660×700	240×1660×700	240×1660×700
	Outdoor	mm	830×900×330	830×900×330	1290×900×330	830×900×330	830×900×330	1290×900×330
Weight	Indoor	kg(lbs)	46 (101)	46 (101)	46 (101)	46 (101)	46 (101)	48 (106)
	Outdoor	kg(lbs)	61 (134)	61 (134)	86 (189)	104 (229)	104 (229)	104 (229)
Connection Pipe Diameter (Liquid / Gas)		mm	9.52/15.88	9.52/15.88	9.52/15.88	9.52/15.88	9.52/15.88	9.52/15.88
Drain port Diameter (I.D./O.D.)		mm	22.0/25.6	22.0/25.6	22.0/25.6	22.0/25.6	22.0/25.6	22.0/25.6
Max Pipe Length (Pre-Charge)		m	50 (20)	50 (20)	50 (20)	75 (30)	75 (30)	75 (30)
Max Height Difference		m	30	30	30	30	30	30
Operation Range	Cooling	°CDB	-15 to 46	-15 to 46	-15 to 46	-15 to 46	-15 to 46	-15 to 46
	Heating	°CDB	-15 to 24	-15 to 24	-15 to 24	-15 to 24	-15 to 24	-15 to 24
Refrigerant	Type (Global Warming Potential)		R410A (2,088)	R410A (2,088)	R410A (2,088)	R410A (2,088)	R410A (2,088)	R410A (2,088)
	Charge	g	2,100	2,100	3,350	3,450	3,450	3,450

Optional parts

- Wired Remote Controller: UTY-RNNYM, UTY-RVNYM
- Simple Remote Controller: UTY-RSNYM
- Drain Pump Unit: UTR-DPB24T
- Flange: UTD-RF204

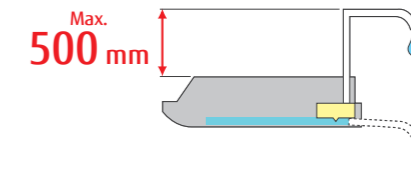

Dimensions

(Unit : mm)

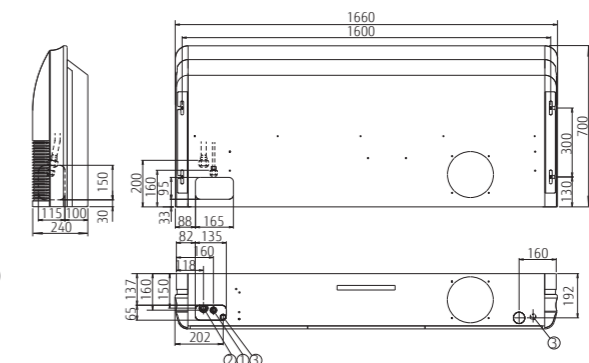

- ① Refrigerant piping flare connection (Liquid)
- ② Refrigerant piping flare connection (Gas)
- ③ Drain piping connection

Compact Cassette 4-way Flow Compact & Comfort



Features

2-stage turbo fan

High efficiency design by 2 stage structure

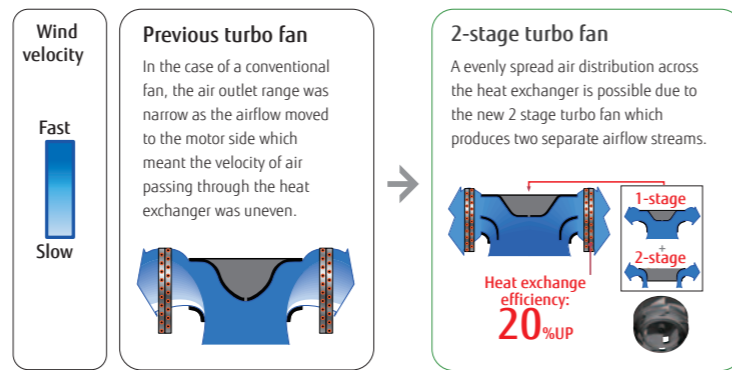

Quiet quality

Optimization of wing form (laminar wing type) and wing number (7 blades each)

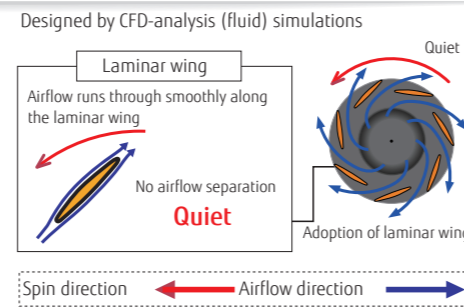

Improvement of the airflow distribution

New louvre: The louvre design distributes air leaving a space between the chassis and the ceiling allowing for wide and wide airflow distribution.

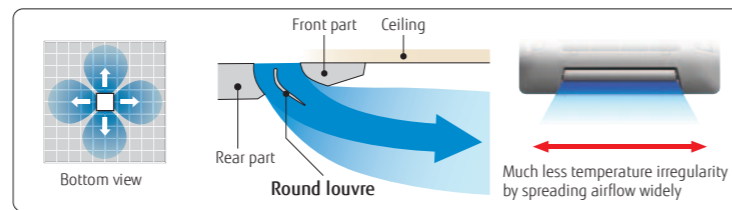

Low ambient operation

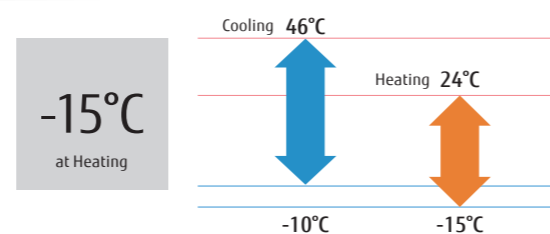

Model : AUYG12LVLB / AUYG14LVLB / AUYG18LVLB / AUYG24LVLA



Wireless R.C.



For AUYG12/14/18LVLB



For AUYG24LVLA

Specifications

Model No.	Indoor unit		AUYG12LVLB	AUYG14LVLB	AUYG18LVLB	AUYG24LVLA
	Outdoor unit		AOYG12LALL	AOYG14LALL	AOYG18LALL	AOYG24LALA
Power Source	Single-phase, ~230V, 50Hz					
Capacity	Cooling	kW	3.5 (0.9-4.4)	4.3 (0.9-5.4)	5.2 (0.9-5.9)	6.8 (0.9-8.0)
	Heating		4.1 (0.9-5.7)	5.0 (0.9-6.5)	6.0 (0.9-7.5)	8.0 (0.9-9.1)
Input Power	Cooling/Heating	kW	1.05/1.11	1.33/1.34	1.62/1.66	2.21/2.26
EER	Cooling	W/W	3.33	3.21	3.21	3.08
COP	Heating		3.69	3.71	3.61	3.54
Pdesign	Cooling/Heating(-10°C)	kW	3.5/4.2	4.3/4.5	5.2/5.2	6.8/6.0
SEER	Cooling	W/W	6.20	6.40	6.20	5.60
SCOP	Heating (Average)		4.10	4.40	4.20	3.90
Energy Efficiency Class	Cooling	A	A++	A++	A++	A+
	Heating (Average)		A+	A+	A+	A
Max. Operating Current	Cooling/Heating	A	7.5/10.0	9.0/12.5	9.0/12.5	12.0/13.5
Annual Energy Consumption	Cooling	kWh/a	198	235	293	425
	Heating		1431	1432	1731	2151
Moisture Removal		l/h	1.2	1.5	2.2	2.7
Sound Pressure Level	Indoor (Cooling)	H/M/L/Q	37/34/30/27	38/34/30/27	38/34/30/26	49/44/36/30
	Indoor (Heating)	H/M/L/Q	37/34/31/29	43/38/34/30	43/38/34/30	49/45/40/33
	Outdoor(Cooling/Heating)	High	47/48	49/49	50/50	52/53
Sound Power Level	Indoor(Cooling/Heating)	High	49/49	50/55	50/55	59/61
	Outdoor(Cooling/Heating)	High	61/63	62/64	62/65	67/70
	Airflow Rate	Indoor / Outdoor	High	600/1780	680/1910	680/2000
Net Dimensions H x W x D	Indoor	mm	245×570×570	245×570×570	245×570×570	245×570×570
	Outdoor	kg(lbs)	15 (33)	15 (33)	15 (33)	16 (35)
Weight	Indoor	mm	578×790×300	578×790×300	578×790×300	578×790×315
	Outdoor	kg(lbs)	40 (88)	40 (88)	40 (88)	44 (97)
Connection Pipe Diameter (Liquid / Gas)		mm	6.35/9.52	6.35/12.70	6.35/12.70	6.35/15.88
Drain hose Diameter (I.D./O.D.)		mm	25/32	25/32	25/32	25/32
Max Pipe Length (Pre-Charge)		m	25 (15)	25 (15)	25 (15)	30 (15)
Max Height Difference		m	15	15	15	20
Operation Range	Cooling	°CDB	-10 to 46	-10 to 46	-10 to 46	-10 to 46
	Heating	°CDB	-15 to 24	-15 to 24	-15 to 24	-15 to 24
Refrigerant	Type (Global Warming Potential)		R410A (2,088)	R410A (2,088)	R410A (2,088)	R410A (2,088)
	Charge	g	1,150	1,250	1,250	1,700
Cassette Grille	Model name		UTG-UFYD-W	UTG-UFYD-W	UTG-UFYD-W	UTG-UFYD-W
	Dimensions (H x W x D)	mm	49×700×700	49×700×700	49×700×700	49×700×700
	Weight	kg(lbs)	2.6 (6)	2.6 (6)	2.6 (6)	2.6 (6)

Optional parts

- Air Outlet Shutter Plate: UTR-YDZB
- Wired Remote Controller: UTY-RNNYM, UTY-RVNYM
- Simple Remote Controller: UTY-RSNYM
- Insulation Kit For High Humidity: UTZ-KXGC
- Fresh Air Intake Kit: UTZ-VXAA



Dimensions

(Unit : mm)

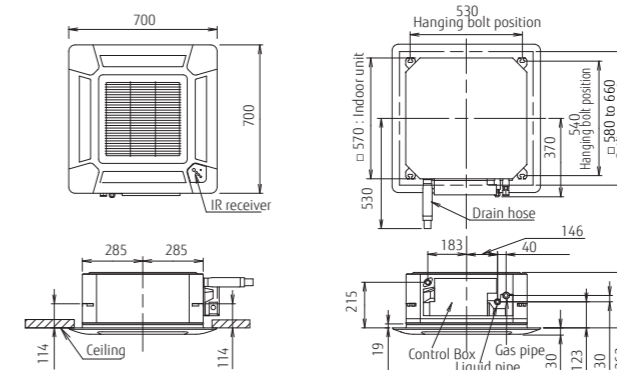

Cassette 4-way Flow Comfort for large room



Single phase

ALL DC i-PAM

Economy Changeover Up/Down Adjust Restart Duct Distributing +Setback Filter Blue Fin

Features

High efficiency turbo fan with 3-dimensional blade

Previous turbo fan: Air passing through the heat exchanger was uneven and the air would only flow close to the ceiling.

New turbo fan: High efficiency airflow distribution has been achieved by the introduction of a 3 dimensional blade which increases the air passing over the heat exchanger.

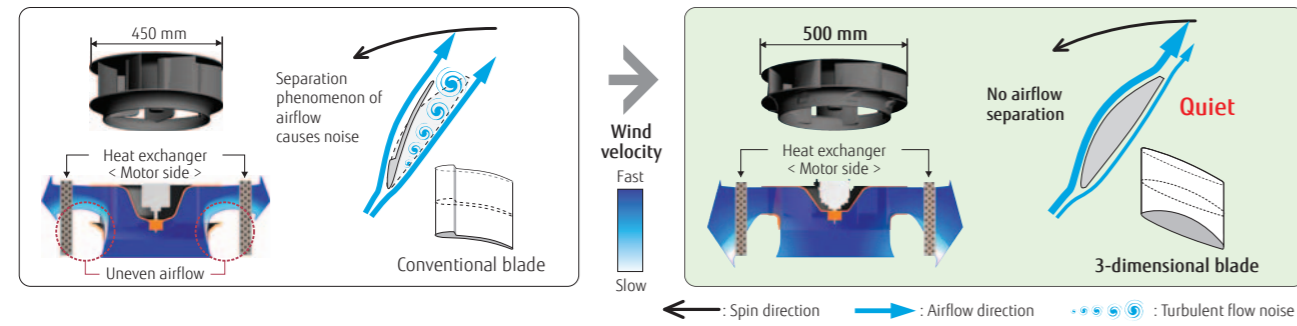

Improvement of the airflow distribution

New louvre: The louvre design distributes air leaving a space between the chassis and the ceiling allowing for wide and uniform airflow distribution.

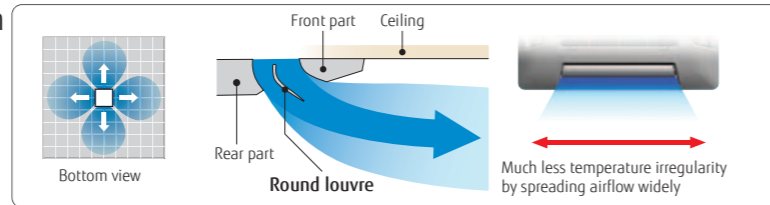

Adjustment of hanger position is possible after installation

Hanging bracket can be checked directly by removing the corner cover. Hanging position can be arranged easily.

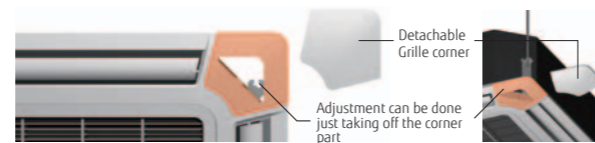

Low ambient operation

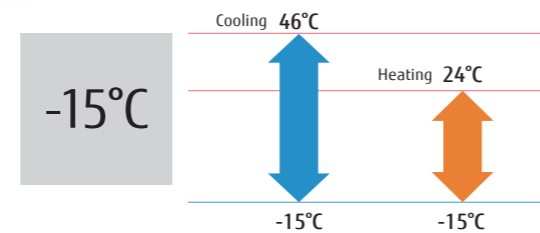

Model : AUYG30LRLE / AUYG36LRLE / AUYG45LRLA / AUYG54LRLA / AUYG36LRLA [3phase] / AUYG45LRLA [3phase] / AUYG54LRLA [3phase]



Specifications

Model No.	Indoor unit				Outdoor unit					
	AUYG30LRLE	AUYG36LRLE	AUYG45LRLA	AUYG54LRLA	AUYG36LRLA	AUYG45LRLA	AUYG54LRLA			
Power Source		Single-phase, ~230V, 50Hz				3-phase, ~400V, 50Hz				
Capacity	Cooling	8.5 (2.8-10.0)	10.0 (2.8-11.2)	12.5 (4.0-14.0)	13.3 (4.5-14.5)	10.0 (4.7-11.4)	12.5 (5.0-14.0)	14.0 (5.4-16.0)		
	Heating	10.0 (2.7-11.2)	11.2 (2.7-12.7)	14.0 (4.2-16.2)	16.0 (4.7-16.5)	11.2 (5.0-14.0)	14.0 (5.4-16.2)	16.0 (5.8-18.0)		
Input Power	Cooling/Heating	2.65/2.77	3.12/3.02	3.88/3.77	4.42/4.69	2.44/2.56	3.54/3.58	4.36/4.43		
	W/W	3.21	3.21	3.22	3.01	4.10	3.53	3.21		
EER	Cooling	3.61	3.71	3.71	3.41	4.38	3.91	3.61		
	Heating	-	-	-	-	-	-	-		
Pdesign	Cooling/Heating(-10°C)	8.5/8.0	10.0/8.7	-	-	10.0/10.0	-	-		
	W/W	6.50	6.30	-	-	6.50	-	-		
SEER	Cooling	4.30	4.20	-	-	4.30	-	-		
	Heating (Average)	-	-	-	-	-	-	-		
SCOP	Cooling	A++	A++	-	-	A++	-	-		
	Heating (Average)	A+	A+	-	-	A+	-	-		
Max. Operating Current	Cooling/Heating	17.0/17.0	18.5/20.0	20.5/20.5	21.5/21.5	7.9/7.9	8.9/8.9	9.9/9.9		
	A	-	-	-	-	-	-	-		
Annual Energy Consumption	Cooling	458	555	-	-	538	-	-		
	Heating	2604	2897	-	-	3253	-	-		
Moisture Removal	l/h	2.5	3.5	4.5	5.0	3.0	4.5	5.0		
	Indoor (Cooling)	H/M/L/Q	40/38/36/32	43/38/36/32	46/42/40/36	47/43/41/37	44/39/36/33	46/42/40/36	47/43/41/37	
Sound Pressure Level	Indoor (Heating)	H/M/L/Q	40/38/36/32	43/38/36/32	46/42/40/36	47/43/41/37	44/39/36/33	46/42/40/36	47/43/41/37	
	Outdoor (Cooling/Heating)	High	53/55	54/55	55/55	55/57	51/53	54/54	55/56	
Sound Power Level	Indoor (Cooling/Heating)	High	54/54	57/57	-	-	58/58	-	-	
	Outdoor (Cooling/Heating)	High	68/69	69/70	-	-	67/69	-	-	
Airflow Rate	Indoor / Outdoor	High	m³/h	1600/3600	1800/3800	1900/6750	2000/6750	1800/6200	1900/6750	2000/6900
	mm	288x840x840	288x840x840	288x840x840	288x840x840	288x840x840	288x840x840	288x840x840	288x840x840	
Net Dimensions	Indoor	kg (lbs)	26 (57)	26 (57)	26 (57)	26 (57)	26 (57)	26 (57)	26 (57)	
	Outdoor	kg (lbs)	61 (135)	61 (135)	86 (190)	86 (190)	104 (229)	104 (229)	104 (229)	
Connection Pipe Diameter (Liquid / Gas)	mm	9.52/15.88	9.52/15.88	9.52/15.88	9.52/15.88	9.52/15.88	9.52/15.88	9.52/15.88		
	mm	25.0/32.0	25.0/32.0	25.0/32.0	25.0/32.0	25.0/32.0	25.0/32.0	25.0/32.0		
Drain hose Diameter (I.D./O.D.)	m	50 (20)	50 (20)	50 (20)	50 (20)	75 (30)	75 (30)	75 (30)		
	m	30	30	30	30	30	30	30		
Max Pipe Length (Pre-Charge)	°CDB	-15 to 46	-15 to 46	-15 to 46	-15 to 46	-15 to 46	-15 to 46	-15 to 46		
	°CDB	-15 to 24	-15 to 24	-15 to 24	-15 to 24	-15 to 24	-15 to 24	-15 to 24		
Operation Range	Type (Global Warming Potential)	R410A (2,088)	R410A (2,088)	R410A (2,088)	R410A (2,088)	R410A (2,088)	R410A (2,088)	R410A (2,088)		
	Charge	g	2,100	2,100	3,350	3,350	3,450	3,450	3,450	
Refrigerant	Model name	UTG-UGYA-W	UTG-UGYA-W	UTG-UGYA-W	UTG-UGYA-W	UTG-UGYA-W	UTG-UGYA-W	UTG-UGYA-W		
	Dimensions (H x W x D)	mm	50×950×950	50×950×950	50×950×950	50×950×950	50×950×950	50×950×950	50×950×950	
Cassette Grille	Weight	kg (lbs)	5.5 (12)	5.5 (12)	5.5 (12)	5.5 (12)	5.5 (12)	5.5 (12)		

Optional parts

Wired Remote Controller:	UTY-RNNYM, UTY-RVNYM	Panel Spacer:	UTG-BKXA-W
Simple Remote Controller:	UTY-RSNYM	Air Outlet Shutter Plate:	UTR-YDZK
IR Receiver Kit:	UTY-LRHYA2	Insulation Kit For High Humidity:	UTZ-KXRA
Wide Panel:	UTG-AKXA-W	Fresh Air Intake Kit:	UTZ-VXRA

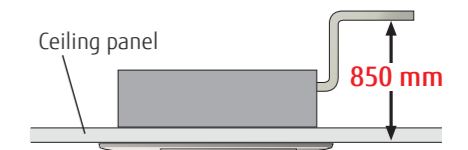

Dimensions

(Unit : mm)

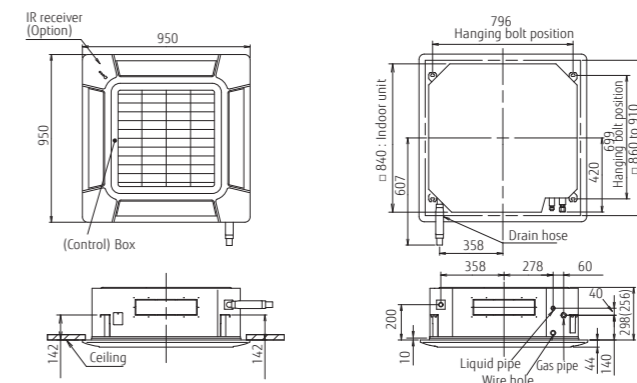



Features

Unique Circular Flow design

New Cassette type realizes Circular Flow to blow large airflow in 360° direction by mounting high performance DC fan motor, new turbo fan and unique seamless airflow louver design.

- ø7mm high density heat exchanger
- New DC fan motor
- High efficient turbo fan
- Seamless airflow louver

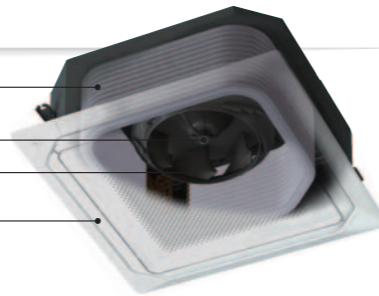

Uniform temperature air conditioning

Achieve a comfortable air conditioning spread to every corner of the room by circular flow & wide vertical airflow.

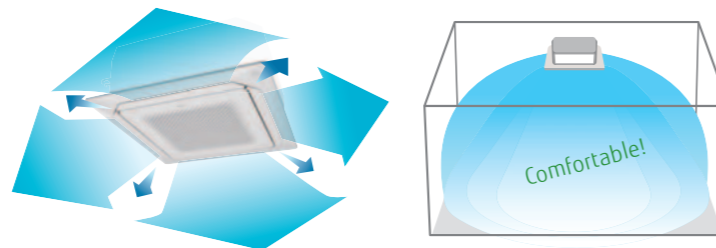

Individual louver control

Each louver can be set individually by Touch Panel Wired Remote Controller to enjoy the comfort of different directional airflows according to various room layouts.

*Touch Panel Wired RC (UTY-RNRYZ1) only

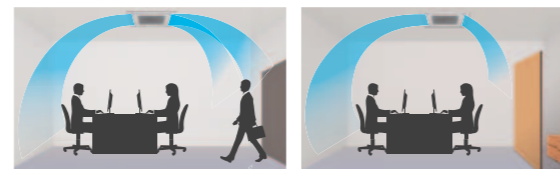

Comfortable air conditioning by preventing direct blowing of cold air and by providing swinging air flow simultaneously.

Efficient air conditioning based on the room layout

Human sensor increases more energy saving

Energy saving operation starts automatically by detecting the motion of a person. 2 modes of save operation mode and stop mode can be selected.

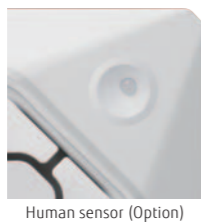

2 modes can be selected.

- Auto saving** Power is saved while people are away.
- Auto OFF** Operation stops after people go out.

*Touch Panel Wired RC (UTY-RNRYZ1) only

Low ambient operation

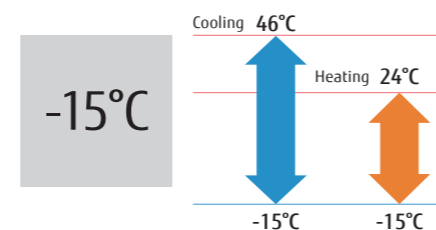

Model: AUXG18LRLB / AUXG24LRLB
AUXG30LRLB / AUXG36LRLB / AUXG45LRLB / AUXG54LRLB



Touch Panel Wired R.C.



For AUXG18/24LRLB

For AUXG30/36LRLB

For AUXG45/54LRLB

Specifications

Model No.	Indoor unit		AUXG18LRLB	AUXG24LRLB	AUXG30LRLB	AUXG36LRLB	AUXG45LRLB	AUXG54LRLB	
	Outdoor unit		AOYG18LBCA	AOYG24LBCA	AOYG30LBTA	AOYG36LBTA	AOYG45LBTA	AOYG54LBTA	
Power Source	Single-phase, ~230V, 50Hz								
Capacity	Cooling	kW	5.2 (0.9-6.5)	6.8 (0.9-8.0)	8.5 (2.8-10.0)	9.5 (2.8-11.2)	12.5 (4.0-14.0)	13.3 (4.5-14.5)	
	Heating		6.0 (0.9-8.0)	7.8 (0.9-9.1)	10.0 (2.7-11.2)	10.8 (2.7-12.7)	14.0 (4.2-16.2)	15.8 (4.7-16.5)	
Input Power	Cooling/Heating	kW	1.42/1.50	2.16/2.18	2.56/2.77	2.96/2.91	3.85/3.73	4.38/4.58	
EER	Cooling	W/W	3.66	3.15	3.32	3.21	3.25	3.04	
	Heating		4.00	3.58	3.61	3.71	3.75	3.45	
Pdesign	Cooling/Heating(-10°C)	kW	5.2/4.3	6.8/6.0	8.5/8.0	9.5/8.7	-	-	
SEER	Cooling	W/W	7.05	6.60	6.70	6.40	-	-	
	Heating (Average)		4.40	4.20	4.30	4.30	-	-	
Energy Efficiency Class	Cooling	A	A++	A++	A++	A++	-	-	
	Heating (Average)		A+	A+	A+	A+	-	-	
Max. Operating Current	Cooling/Heating	kWh/a	10.0/13.5	13.5/18.5	17.0/17.0	20.0/20.0	20.5/20.5	21.5/21.5	
	Cooling		258	361	444	519	-	-	
Annual Energy Consumption	Heating	l/h	1367	1999	2604	2833	-	-	
	Cooling		2.2	2.7	2.5	3.3	4.5	5.0	
Sound Pressure Level	Indoor (Cooling)	H/M/L/Q	33/32/31/28	35/33/32/29	40/38/36/33	44/41/38/34	46/42/39/35	47/43/40/36	
	Indoor (Heating)		33/32/31/28	35/33/32/29	40/38/36/33	44/41/38/34	46/42/39/35	47/43/40/36	
Sound Power Level	Outdoor(Cooling/Heating)	High	51/50	55/56	53/55	54/55	55/55	55/57	
	Indoor(Cooling/Heating)		47/47	49/49	54/54	58/58	60/60	61/61	
Airflow Rate	Outdoor(Cooling/Heating)	High	64/62	68/68	67/69	68/70	68/68	69/71	
	Indoor / Outdoor		High	m³/h	1050/1900	1150/2460	1600/3600	1900/3800	2000/6750
Net Dimensions H x W x D	Indoor	kg(lbs)	mm	246×840×840	246×840×840	288×840×840	288×840×840	288×840×840	288×840×840
			mm	24 (53)	24 (53)	26 (57)	26 (57)	29 (64)	29 (64)
Weight	Outdoor	kg(lbs)	mm	620×790×290	620×790×290	830×900×330	830×900×330	1290×900×330	1290×900×330
			mm	41 (90)	41 (90)	61 (134)	61 (134)	86 (189)	86 (189)
Connection Pipe Diameter (Liquid / Gas)	mm		6.35/12.7	6.35/15.88	9.52/15.88	9.52/15.88	9.52/15.88	9.52/15.88	
Drain hose Diameter (I.D./O.D.)	mm		25/32	25/32	25/32	25/32	25/32	25/32	
Max Pipe Length (Pre-Charge)	m		30 (15)	30 (15)	50 (20)	50 (20)	50 (20)	50 (20)	
Max Height Difference	m		20	20	30	30	30	30	
Operation Range	Cooling	°CDB	-15 to 46	-15 to 46	-15 to 46	-15 to 46	-15 to 46	-15 to 46	
	Heating		-15 to 24	-15 to 24	-15 to 24	-15 to 24	-15 to 24	-15 to 24	
Refrigerant	Type (Global Warming Potential)	R410A (2,088)							
	Charge	g	1,800	1,800	2,100	2,100	3,350	3,350	
Cassette Grille	Model name	UTG-UKYA-W							
	Dimensions (H x W x D)	mm	53×950×950	53×950×950	53×950×950	53×950×950	53×950×950	53×950×950	
	Weight	kg(lbs)	6.0 (13)	6.0 (13)	6.0 (13)	6.0 (13)	6.0 (13)	6.0 (13)	

Optional parts

- Wired Remote Controller: UTY-RNRYZ1, UTY-RVNYM, UTY-RLRY, UTY-RNNYM
- Simple Remote Controller: UTY-RSNYM
- IR Receiver Kit: UTY-LBTYC
- Human Sensor Kit: UTY-SHZXC
- Wide Panel: UTY-AKXA-W
- Panel Spacer: UTY-BKXA-W
- Air Outlet Shutter Plate: UTR-YDZK
- Insulation Kit For High Humidity: UTZ-KXRA
- Fresh Air Intake Kit: UTZ-VXRA
- External input and output PCB (with box): UTY-XCSX + UTZ-GXRA
- External connect kit: UTY-XWZXZG, UTY-XWZXZ3

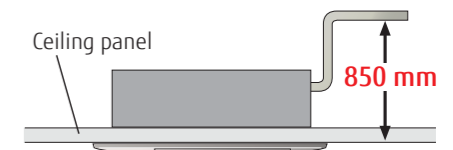

Dimensions

(Unit : mm)

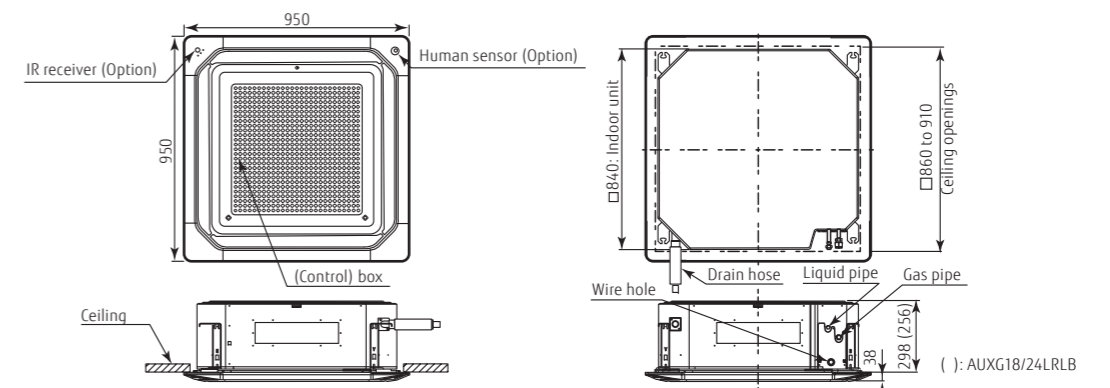

Slim Duct Slim & Comfort



Features

Slim design

The slim design allows installations where ceilings are narrow. Drain hose as standard accessory

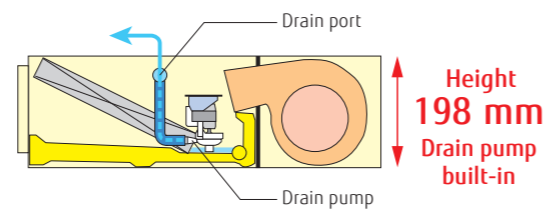

Flexible installation

2-type installation methods of ceiling concealed and floor concealed can be selected.

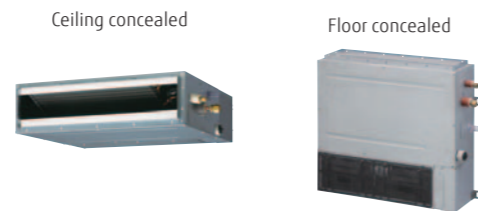

Selectable with a wide range of static pressure

By using the DC fan motor, it is possible to change the static pressure range from 0 to 90 Pa. The change of static pressure range is possible by remote controller.



Static pressure range
0 to 90 Pa

Auto Louver Grille Kit (Option)

Simple flat Auto Louver will provide comfort airflow and harmonize with luxury interior.

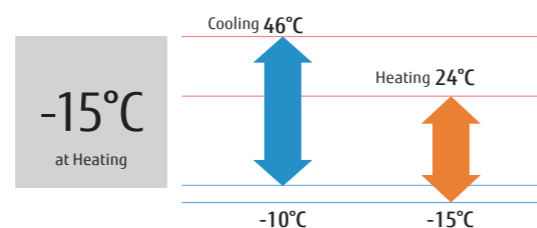
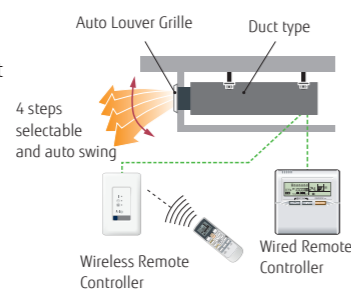

Model : ARYG12LLTB / ARYG14LLTB / ARYG18LLTB



Wired R.C.

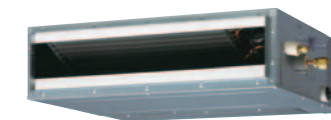

ARYG12/14LLTB

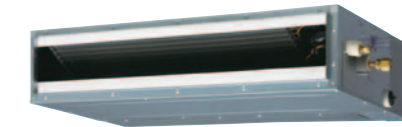

ARYG18LLTB



Specifications

Model No.	Indoor unit		ARYG12LLTB	ARYG14LLTB	ARYG18LLTB
	Outdoor unit		AOYG12LALL	AOYG14LALL	AOYG18LALL
Power Source	Single-phase, ~230V, 50Hz				
Capacity	Cooling	kW	3.5 (0.9-4.4)	4.3 (0.9-5.4)	5.2 (0.9-5.9)
	Heating	kW	4.1 (0.9-5.7)	5.0 (0.9-6.5)	6.0 (0.9-7.5)
Input Power	Cooling/Heating		1.05/1.11	1.33/1.34	1.62/1.66
	Cooling	W/W	3.33	3.21	3.21
EER	Cooling		3.33	3.21	3.21
	Heating	W/W	3.69	3.71	3.61
COP	Cooling/Heating(-10°C)		3.5/4.2	4.3/4.5	5.2/5.2
	Cooling	W/W	5.90	5.80	6.20
SEER	Cooling		5.90	5.80	6.20
	Heating	W/W	4.00	3.90	4.10
SCOP	Cooling		A+	A+	A++
	Heating		A+	A	A+
Max. Operating Current	Cooling/Heating		7.5/10.0	9.0/12.5	9.0/12.5
	Cooling	kWh/a	207	259	293
Annual Energy Consumption	Cooling		1467	1614	1774
	Heating		1.3	1.5	2.0
Moisture Removal	Indoor (Cooling)		29/28/26/25	32/30/28/26	32/30/29/27
	Indoor (Heating)		29/28/26/24	32/30/28/25	32/30/29/27
Sound Pressure Level	Outdoor(Cooling/Heating)		High	49/49	50/50
	Indoor(Cooling/Heating)		High	58/58	58/58
Sound Power Level	Outdoor(Cooling/Heating)		High	61/63	62/65
	Indoor / Outdoor		High	650/1780	800/1910
Airflow Rate	Indoor / Outdoor		High	650/1780	800/1910
	Static pressure range (Standard)		Pa	0 to 90 (25)	0 to 90 (25)
Net Dimensions	Indoor		mm	198*700*620	198*900*620
	H x W x D		kg(lbs)	19 (42)	19 (42)
Weight	Outdoor		mm	578*790*300	578*790*300
			kg(lbs)	40 (88)	40 (88)
Connection Pipe Diameter (Liquid / Gas)			mm	6.35/9.52	6.35/12.70
	Drain hose Diameter (I.D./O.D.)		mm	25/32	25/32
Max Pipe Length (Pre-Charge)			m	25 (15)	25 (15)
	Max Height Difference			15	15
Operation Range	Cooling		°CDB	-10 to 46	-10 to 46
	Heating		°CDB	-15 to 24	-15 to 24
Refrigerant	Type (Global Warming Potential)			R410A (2,088)	R410A (2,088)
	Charge		g	1,150	1,250

Optional parts

- Wired Remote Controller: UTY-RNNYM, UTY-RVNYM
- Simple Remote Controller: UTY-RSNYM
- IR Receiver Kit: UTY-LRHYM
- Remote Sensor Unit: UTY-XSZX
- Auto Louver Grille Kit: UTD-GXTA-W (For ARYG12 / 14LLTB)
UTD-GXTB-W (For ARYG18LLTB)

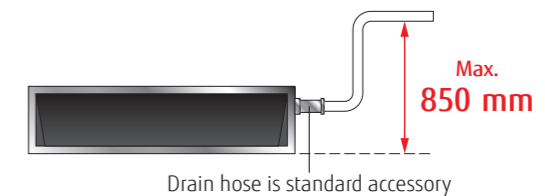

Dimensions

(Unit : mm)

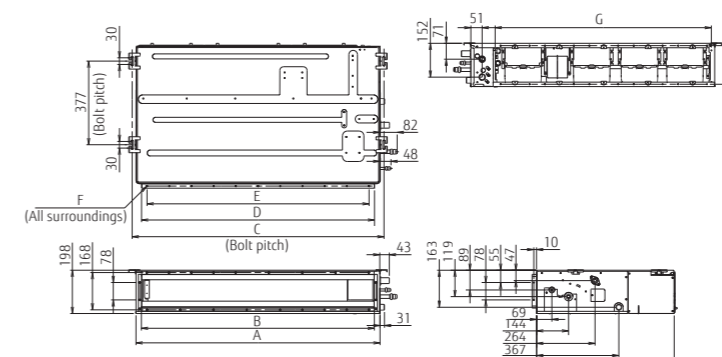

	ARYG12 / 14LLTB	ARYG18LLTB
A	700	900
B	650	850
C	734	934
D	650	850
E	P100x6=600	P100x8=800
F	18xØ5	22xØ5
G	574	774

Medium Static Pressure Duct High Efficiency & Comfort



Features

Slim & Compact design

In the case of bottom return air connection, not only does the indoor unit design allow for installation in a narrow ceiling space of up to 270 mm, Further space savings have been achieved by mounting the control box internally inside the chassis.

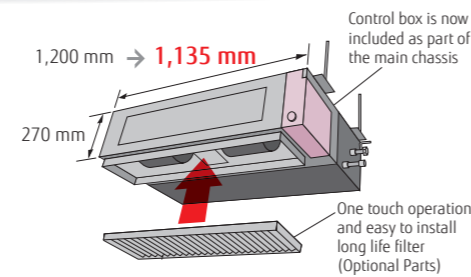

Two-direction drain piping

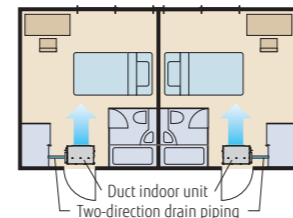

Easy maintenance

Structural improvement is attained by making the bottom panel two pieces, front and rear. The internal fan casing is also manufactured in two pieces, namely upper and lower. The maintenance of the motor and fan can be easily carried out by removing the rear panel and the lower part of the casing while leaving the main chassis installed.

See below for the case of rear suction type

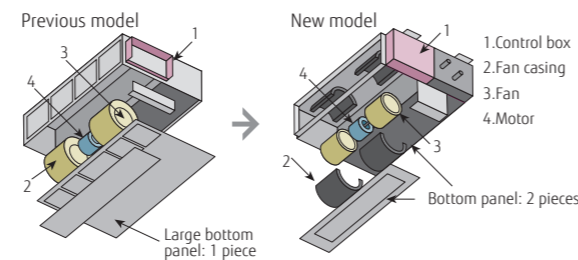

Low ambient operation

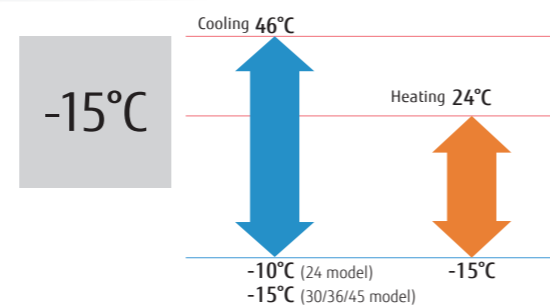

Model : ARYG24LMLA / ARYG30LMLE / ARYG36LMLE / ARYG45LMLA / ARYG36LMLA [3phase] / ARYG45LMLA [3phase]



Wired R.C.



For ARYG24LMLA



For ARYG30/36LMLE



For ARYG36/45LMLA

Specifications

Model No.	Indoor unit		ARYG24LMLA	ARYG30LMLE	ARYG36LMLE	ARYG45LMLA	ARYG36LMLA	ARYG45LMLA
	Outdoor unit		AOYG24LALA	AOYG30LETL	AOYG36LETL	AOYG45LETL	AOYG36LATT	AOYG45LATT
Power Source	Single-phase, ~230V, 50Hz						3-phase, ~400V, 50Hz	
Capacity	Cooling	kW	6.8 (0.9-8.0)	8.5 (2.8-10.0)	9.4 (2.8-11.2)	12.1 (4.0-13.3)	10.0 (4.7-11.4)	12.5 (5.0-14.0)
	Heating		8.0 (0.9-9.1)	10.0 (2.7-11.2)	11.2 (2.7-12.7)	13.1 (4.2-15.5)	11.2 (5.0-14.0)	14.0 (5.4-16.2)
Input Power	Cooling/Heating	kW	2.21/2.26	2.65/2.68	2.96/3.10	3.77/3.68	2.84/2.87	3.89/3.88
EER	Cooling	W/W	3.08	3.21	3.18	3.21	3.52	3.21
COP	Heating		3.54	3.73	3.61	3.61	3.90	3.61
Pdesign	Cooling/Heating(-10°C)	kW	6.8/6.0	8.5/8.0	9.4/8.7	-	10.0/10.0	-
SEER	Cooling	W/W	6.20	5.90	5.70	-	5.80	-
SCOP	Heating		4.00	3.90	3.80	-	4.00	-
Energy Efficiency Class	Cooling	A	A++	A+	A+	-	A+	-
	Heating		A+	A	A	-	A+	-
Max. Operating Current	Cooling/Heating	A	12.0/13.5	17.0/17.0	18.5/20.0	21.0/21.0	8.5/8.5	9.5/9.5
Annual Energy Consumption	Cooling	kWh/a	384	504	576	-	603	-
	Heating		2098	2868	3202	-	3497	-
Moisture Removal		l/h	2.5	2.5	3.0	4.0	3.0	4.5
Sound Pressure Level	Indoor (Cooling)	H/M/L/Q	31/29/27/25	39/35/30/26	39/35/30/26	42/38/32/28	38/36/31/26	42/38/32/28
	Indoor (Heating)		H/M/L/Q	31/29/27/25	42/35/30/26	42/35/30/26	42/38/32/28	40/36/31/26
Sound Power Level	Outdoor(Cooling/Heating)	High	52/53	53/55	54/55	55/55	51/53	54/54
	Indoor(Cooling/Heating)		High	60/62	65/69	65/70	-	65/67
Airflow Rate	Indoor / Outdoor	High	67/70	68/69	69/70	-	67/69	-
	Indoor / Outdoor		m³/h	1100/2470	1900/3600	1900/3800	2100/6750	1800/6200
Static pressure range (Standard)		Pa	30 to 150 (35)	30 to 150 (47)	30 to 150 (47)	30 to 150 (60)	30 to 150 (47)	30 to 150 (60)
			mm	270x1135x700	270x1135x700	270x1135x700	270x1135x700	270x1135x700
Net Dimensions H x W x D	Indoor	kg(lbs)	38 (84)	40 (88)	40 (88)	40 (88)	40 (88)	40 (88)
	Outdoor		mm	578x790x315	830x900x330	830x900x330	1290x900x330	1290x900x330
Weight	Indoor	kg(lbs)	44 (97)	61 (134)	61 (134)	86 (190)	104 (229)	104 (229)
	Outdoor		kg(lbs)	6.35/15.88	9.52/15.88	9.52/15.88	9.52/15.88	9.52/15.88
Connection Pipe Diameter (Liquid / Gas)		mm	35.7/38.1	35.7/38.1	35.7/38.1	35.7/38.1	35.7/38.1	35.7/38.1
Drain hose Diameter (I.D./O.D.)		mm	30 (15)	50 (20)	50 (20)	50 (20)	75 (30)	75 (30)
Max Pipe Length (Pre-Charge)		m	20	30	30	30	30	30
Max Height Difference	Cooling	°CDB	-10 to 46	-15 to 46	-15 to 46	-15 to 46	-15 to 46	-15 to 46
	Heating		-15 to 24	-15 to 24	-15 to 24	-15 to 24	-15 to 24	-15 to 24
Refrigerant	Type (Global Warming Potential)		R410A (2,088)	R410A (2,088)	R410A (2,088)	R410A (2,088)	R410A (2,088)	R410A (2,088)
	Charge	g	1,700	2,100	2,100	3,350	3,450	3,450

Optional parts

Wired Remote Controller:	UTY-RNNYM, UTY-RVNYM	Long Life Filter:	UTD-LF25NA
Simple Remote Controller:	UTY-RSNYM	Remote Sensor Unit:	UTY-XS2X
Flange (Round):	UTD-RF204	Drain Pump Unit:	UTZ-PX1NBA
Flange (Square):	UTD-SF045T	IR Receiver Kit:	UTY-LRHYM

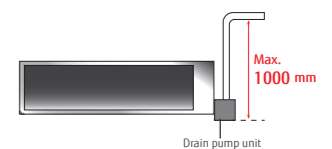

Dimensions

(Unit : mm)

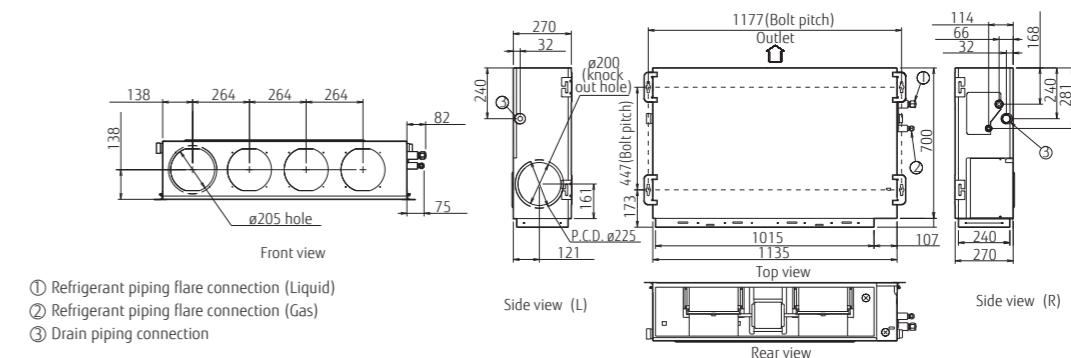

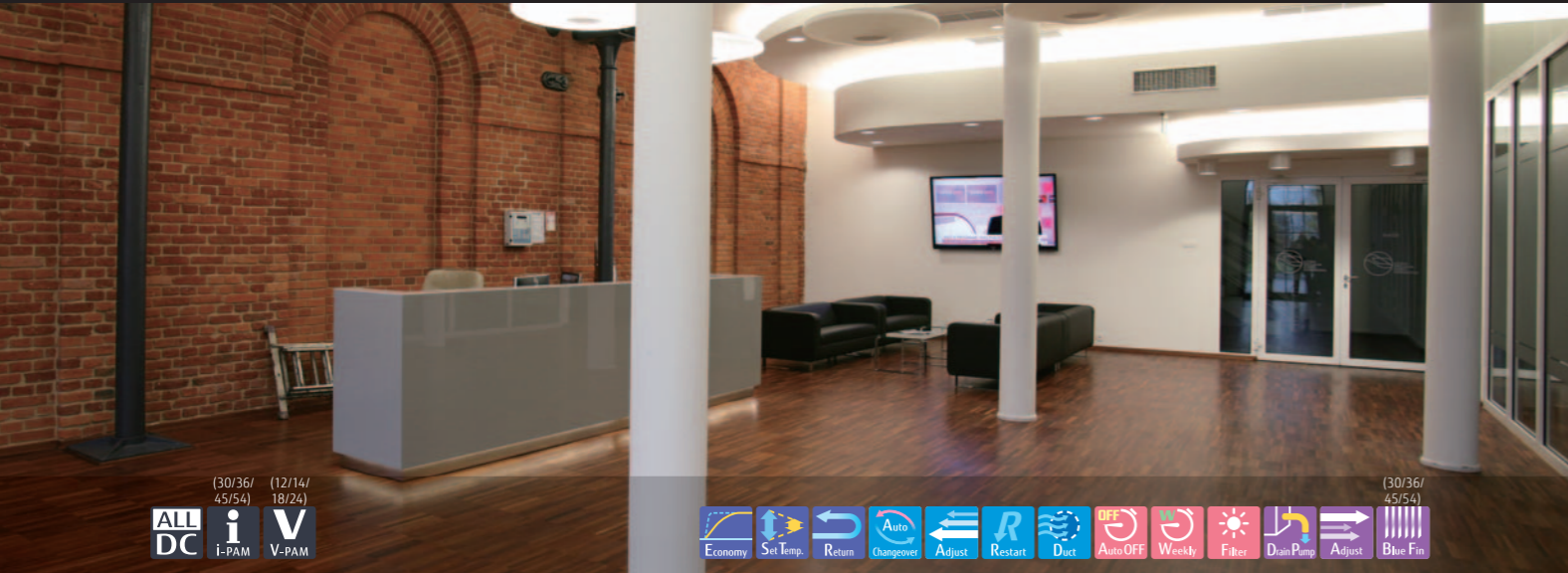

Features

High Efficiency & Quiet operation

The combination of the V-shaped heat exchanger, air stabilizer, and the high efficient DC fan motor allowed high efficiency and quiet operation despite of the small structural design.

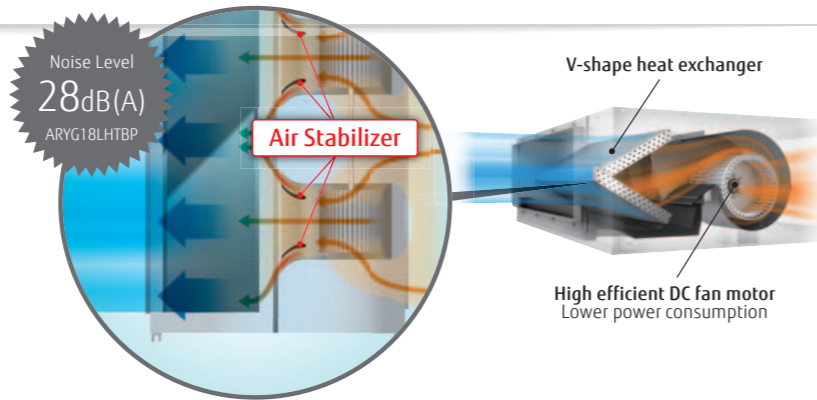

Automatic Airflow adjustment function

This unique and innovative function detects required air flow in each application case and automatically adjust the volume.



Improved installation flexibility

- Capable to be installed in various applications that requires static pressure of 30Pa to 200 Pa
- Built-in drain pump, rises drain up to 850 mm
- Unified depth throughout the range enables the selection of the capacity regardless of the additional space.

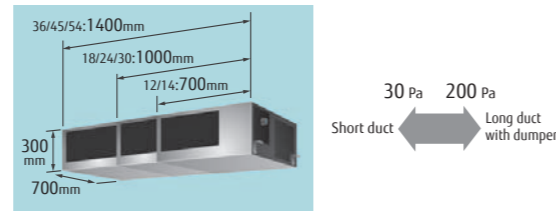

Improved service and maintenance

- Drain pump is easily detachable from the side
- Easy access to electrical box
- Error code can be checked more in detail from error history

Low ambient operation

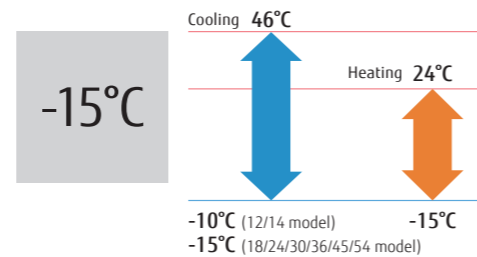

Model: ARYG12LHTBP / ARYG14LHTBP / ARYG18LHTBP / ARYG24LHTBP / ARYG30LHTBP / ARYG36LHTBP / ARYG45LHTBP / ARYG54LHTBP



Specifications

Model No.	Indoor unit	Outdoor unit	ARYG12LHTBP	ARYG14LHTBP	ARYG18LHTBP	ARYG24LHTBP	ARYG30LHTBP	ARYG36LHTBP	ARYG45LHTBP	ARYG54LHTBP
			AOYG12LBLE	AOYG14LBLE	AOYG18LBCA	AOYG24LBCA	AOYG30LBTA	AOYG36LBTA	AOYG45LBTB	AOYG54LBTA
Power Source	Single-phase, ~230V, 50Hz									
Capacity	Cooling	kw	3.5 (0.9-4.4)	4.3 (0.9-5.4)	5.2 (0.9-6.5)	6.8 (0.9-8.0)	8.5 (2.8-10.0)	9.4 (2.8-11.2)	12.1 (4.0-14.0)	13.4 (4.5-14.5)
	Heating	kw	4.1 (0.9-5.7)	5.0 (0.9-6.5)	6.0 (0.9-8.0)	8.0 (0.9-9.1)	10.0 (2.7-11.2)	11.2 (2.7-12.7)	13.3 (4.2-16.2)	16.0 (4.7-16.5)
Input Power	Cooling/Heating	kw	0.90/1.00	1.18/1.25	1.37/1.48	1.95/2.21	2.65/2.70	2.83/3.07	3.59/3.44	4.42/4.62
	Cooling	W/W	3.89	3.64	3.80	3.49	3.21	3.32	3.37	3.03
COP	Cooling		4.10	4.00	4.05	3.62	3.70	3.65	3.87	3.46
	Heating		4.10	4.00	4.11	4.01	3.95	3.81	-	-
Pdesign	Cooling/Heating(-10°C)	kw	3.5/4.2	4.3/4.5	5.2/4.3	6.8/6.0	8.5/8.0	9.4/8.7	-	-
SEER	Cooling	W/W	6.20	6.10	7.15	6.50	5.95	5.81	-	-
	Heating (Average)		4.10	4.00	4.11	4.01	3.95	3.81	-	-
SCOP	Cooling		A++	A++	A++	A++	A+	A+	-	-
	Heating (Average)		A+	A+	A+	A+	A	A	-	-
Max. Operating Current	Cooling/Heating	A	7.5/10.0	9.0/12.5	10.0/13.5	13.5/18.5	17.0/17.0	20.0/20.0	22.5/22.5	23.5/23.5
	Cooling	kWh/a	*	*	255	366	500	566	*	*
Annual Energy Consumption	Heating	kWh/a	*	*	1462	2092	2833	3194	*	*
		l/h	*	*	1.2	1.8	2.3	2.0	2.6	3.7
Moisture Removal	Indoor (Cooling)	H/M/L/Q	32/27/26/24	33/28/27/25	28/25/22/20	32/28/24/21	36/33/30/29	36/31/28/26	39/35/31/29	39/35/31/29
	Indoor (Heating)	H/M/L/Q	32/27/26/24	33/28/27/25	28/25/22/20	32/28/24/21	36/33/30/29	33/31/28/26	39/35/31/29	39/35/31/29
Sound Pressure Level	Outdoor(Cooling/Heating)	High	47/48	49/49	50/51	55/56	53/55	54/55	55/55	55/57
	Indoor(Cooling/Heating)	High	*	*	54/54	57/57	63/65	64/63	67/69	67/69
Sound Power Level	Outdoor(Cooling/Heating)	High	60/61	64/63	63/62	68/68	68/69	69/70	68/68	69/71
	Indoor / Outdoor	High	m³/h	850/1780	950/1910	1050/ 1900	1360/ 2460	1700/ 3600	2050/ 3800	2550/ 6750
Static pressure range (Standard)		Pa	30 to 200 (35)	30 to 200 (35)	30 to 200 (35)	30 to 200 (35)	30 to 200 (47)	30 to 200 (47)	30 to 200 (60)	30 to 200 (60)
		mm	300~700~700	300~700~700	300~1000~700	300~1000~700	300~1000~700	300~1400~700	300~1400~700	300~1400~700
Net Dimensions H x W x D	Indoor	mm	27 (59)	27 (59)	36 (79)	36 (79)	36 (79)	46 (101)	46 (101)	46 (101)
	Outdoor	mm	578~790~300	578~790~300	620~790~290	620~790~290	830~900~330	830~900~330	1290~900~330	1290~900~330
Weight	Indoor	kg(lbs)	40 (88)	40 (88)	41 (90)	41 (90)	61 (134)	61 (134)	86 (189)	86 (189)
	Outdoor	kg(lbs)	6.35/9.52	6.35/12.70	6.35/12.70	6.35/15.88	9.52/15.88	9.52/15.88	9.52/15.88	9.52/15.88
Connection Pipe Diameter (Liquid / Gas)		mm	25/32	25/32	25/32	25/32	25/32	25/32	25/32	25/32
	Drain hose Diameter (I.D./O.D.)		25 (15)	25 (15)	30 (15)	30 (15)	50 (20)	50 (20)	50 (20)	50 (20)
Max Pipe Length (Pre-Charge)		m	15	15	20	20	30	30	30	30
	Max Height Difference		°CDB	-10 to 46	-10 to 46	-15 to 46	-15 to 46	-15 to 46	-15 to 46	-15 to 46
Operation Range	Cooling		-15 to 24	-15 to 24	-15 to 24	-15 to 24	-15 to 24	-15 to 24	-15 to 24	-15 to 24
	Heating		R410A (2,088)	R410A (2,088)	R410A (2,088)	R410A (2,088)	R410A (2,088)	R410A (2,088)	R410A (2,088)	R410A (2,088)
Refrigerant	Type (Global Warming Potential)		1,150	1,250	1,800	1,800	2,100	2,100	3,350	3,350
	Charge	g								

*.That specification is not fixed yet.

Optional parts

- Wired Remote Controller: UTY-RNRYZ1, UTY-RVNYM, UTY-RNNYM, UTY-RLRY Long life filter: UTD-LFNA (for ARYG36/45/54LHTBP)
- Simple Remote Controller: UTY-RSNYM UTD-LFNB (for ARYG24/30LHTBP)
- IR Receiver Unit: UTY-LBTYM UTD-LFNC (for ARYG12/14LHTBP)
- External input and output PCB (with bracket): UTY-XCSX + UTZ-GXNA Remote Sensor Unit: UTY-XSZX
- External connect kit: UTY-XWZXG, UTY-XWZXZ3

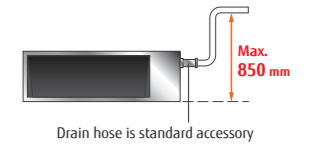

Dimensions

(Unit : mm)

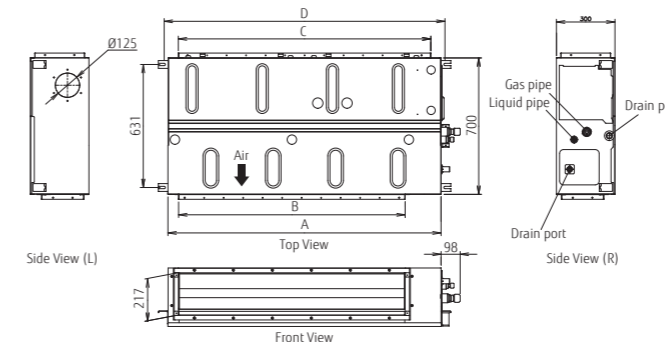

	ARYG12/14LHTBP	ARYG18/24/30LHTBP	ARYG36/45/54LHTBP
A	700	1,000	1,400
B	462	762	1,162
C	650	895	1,295
D	740	1,040	1,440

High Static Pressure Duct



Features

High energy efficiency

Significantly greater efficiency is realized by using all DC inverter technology. (60 type)

Design also corresponding to high static pressure

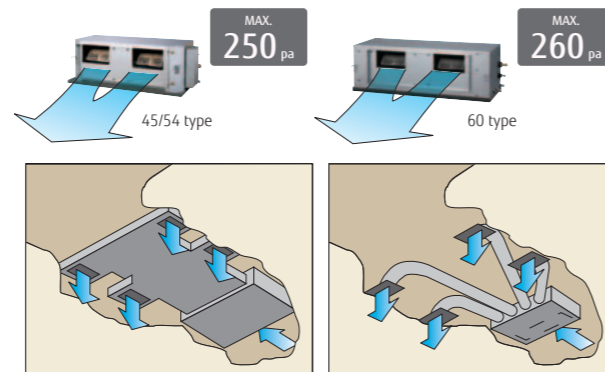

Easy installation (Compact size & Lightweight)

A compact size and lightweight indoor unit has been developed by reducing the basic chassis and the overall material weight.

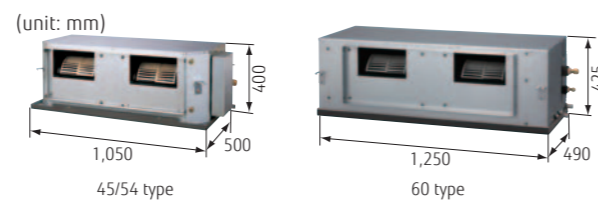

Low noise

Cutting off the corners has enabled less turbulent airflow. Low noise is realized by adopting a plastic case and a plastic fan.

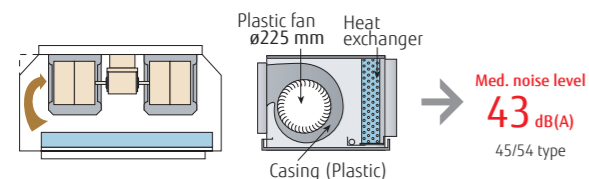

Low ambient operation

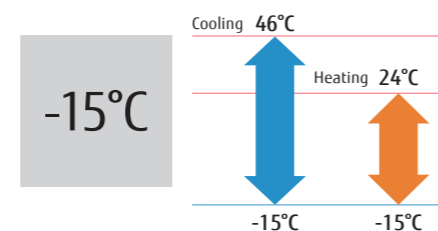

Model : ARYG45LHTA / ARYG54LHTA /
ARYG45LHTA [3phase] / ARYG54LHTA [3phase] / ARYG60LHTA [3phase]

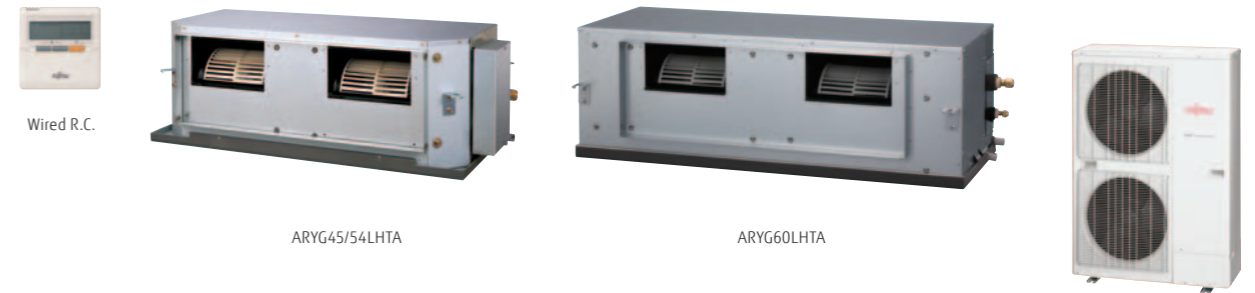

Specifications

Model No.	Indoor unit		ARYG45LHTA	ARYG54LHTA	ARYG45LHTA	ARYG54LHTA	ARYG60LHTA
	Outdoor unit		AOYG45LETL	AOYG54LETL	AOYG45LATT	AOYG54LATT	AOYG60LATT
Power Source	Single-phase, ~230V, 50Hz			3-phase, ~400V, 50Hz			
Capacity	Cooling	kW	12.5 (4.5-14.0)	13.4 (5.0-14.5)	12.5 (5.0-14.0)	14.0 (5.4-16.0)	15.0 (6.2-17.5)
	Heating	kW	14.0 (5.0-16.2)	16.0 (5.5-18.0)	14.0 (5.4-16.2)	16.0 (5.8-18.0)	18.0 (6.2-20.0)
Input Power	Cooling/Heating	kW	4.30/3.80	4.77/4.69	4.06/3.67	4.65/4.37	4.70/5.15
EER	Cooling		2.91	2.81	3.08	3.01	3.19
	Heating		3.68	3.41	3.81	3.66	3.50
Max. Operating Current	Cooling/Heating	A	22.5/22.5	23.5/23.5	11.0/11.0	12.0/12.0	12.5/12.5
Moisture Removal		l/h	1.5	2.0	1.5	2.5	2.0
Sound Pressure	Indoor (Cooling)	H/M/L/Q	47/43/40/-	47/43/40/-	47/43/40/-	47/43/40/-	45/40/36/-
	Indoor (Heating)	H/M/L/Q	47/43/40/-	47/43/40/-	47/43/40/-	47/43/40/-	45/40/36/-
	Outdoor (Cooling/Heating)	High	55/55	55/57	54/54	55/56	56/58
Airflow Rate	Indoor / Outdoor	High	3350/6750	3350/6750	3350/6750	3350/6900	3550/6900
Static pressure range (Standard)		Pa	100 to 250 (100)	100 to 250 (100)	100 to 250 (100)	100 to 250 (100)	60 to 260 (60)
Net Dimensions H x W x D	Indoor	mm	400×1050×500	400×1050×500	400×1050×500	400×1050×500	425×1250×490
		kg(lbs)	46 (101)	46 (101)	46 (101)	46 (101)	54 (119)
Weight	Outdoor	mm	1290×900×330	1290×900×330	1290×900×330	1290×900×330	1290×900×330
		kg(lbs)	86 (189)	86 (189)	104 (229)	104 (229)	104 (229)
Connection Pipe Diameter (Liquid / Gas)		mm	9.52/15.88	9.52/15.88	9.52/15.88	9.52/15.88	9.52/15.88
Drain hose Diameter (I.D./O.D.)		mm	23.4/25.4	23.4/25.4	23.4/25.4	23.4/25.4	23.4/25.4
Max Pipe Length (Pre-Charge)		m	50 (20)	50 (20)	75 (30)	75 (30)	75 (30)
Max Height Difference			30	30	30	30	30
Operation Range	Cooling	°CDB	-15 to 46	-15 to 46	-15 to 46	-15 to 46	-15 to 46
	Heating	°CDB	-15 to 24	-15 to 24	-15 to 24	-15 to 24	-15 to 24
Refrigerant	Type (Global Warming Potential)		R410A (2,088)	R410A (2,088)	R410A (2,088)	R410A (2,088)	R410A (2,088)
	Charge	g	3,350	3,350	3,450	3,450	3,450

Optional parts

- Wired Remote Controller: UTY-RNNYM, UTY-RVNYM
- Simple Remote Controller: UTY-RSNYM
- Long-Life Filter: UTD-LF60KA (For ARYG45/54LHTA only)
- Remote Sensor Unit: UTY-XSZX
- IR Receiver Kit: UTY-LRHYM (For ARYG60LHTA only)

Dimensions

(Unit : mm)

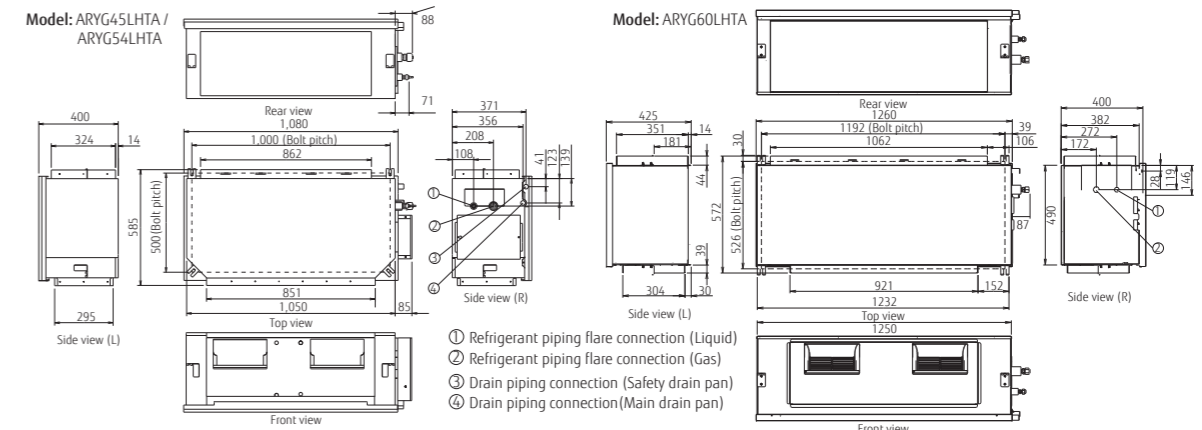

High Static Pressure Duct



Features

High energy efficiency

Significantly greater efficiency is realized by using DC twin rotary compressor, all DC inverter technology, and large heat exchanger.

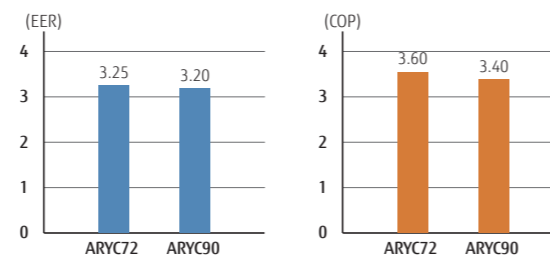

5 Static Pressure selection

Improvement and design flexibility has allowed multiple fan speeds and static pressure modes. Low noise is realized by adopting plastic case, plastic fan.

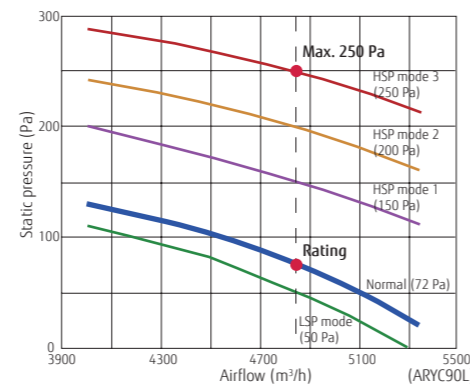

Outdoor unit quiet operation

A low outdoor noise operation mode allows the outdoor unit to have two quiet mode operation settings.

Peak cut operation

A peak power consumption mode controls a 4 step outdoor operation control to cut down energy usage at peak energy usage times.

Low ambient operation

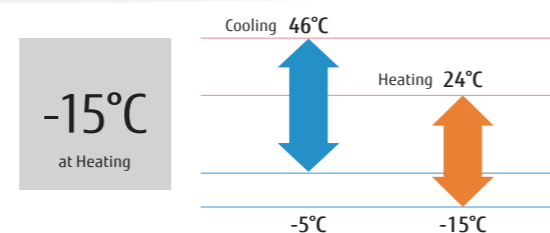

Model : ARYC72LHTA [3phase] / ARYC90LHTA [3phase]



Wired R.C.



ARYC72LHTA



ARYC90LHTA



Specifications

Model No.	Indoor unit		ARYC72LHTA	ARYC90LHTA
	Outdoor unit		AOYA72LALT	AOYA90LALT
Power Source	3-phase, ~400V, 50Hz			
Capacity	Cooling	kW	20.3 (10.8-23.5)	25.0 (11.2-28.0)
	Heating	kW	22.6 (12.0-26.5)	28.0 (12.5-31.5)
Input Power	Cooling/Heating	kW	6.25/6.27	7.82/8.24
EER	Cooling	W/W	3.25	3.20
COP	Heating	W/W	3.60	3.40
Max. Operating Current	Cooling/Heating	A	22.8/22.8	25.8/25.8
Moisture Removal		l/h	4.5	6.0
Sound Pressure	Indoor (Cooling)	H/M/L/Q	47/44/41/-	49/46/43/-
	Indoor (Heating)	H/M/L/Q	47/44/41/-	49/46/43/-
	Outdoor (Cooling/Heating)	High	57/57	58/59
Airflow Rate	Indoor / Outdoor	High	4300/9300	4850/10700
Static pressure range (Standard)		Pa	50 to 250 (72)	50 to 250 (72)
Net Dimensions H x W x D	Indoor	mm	450×1587×700	550×1587×700
	Outdoor	mm	100 (220)	110 (242)
Weight	Indoor	kg(lbs)	1690×930×765	1690×930×765
	Outdoor	kg(lbs)	215 (473)	215 (473)
Connection Pipe Diameter (Liquid / Gas)		mm	12.70/25.40	12.70/25.40
Drain Hose Diameter (I.D./O.D.)		mm	35.7/38.1	35.7/38.1
Max Pipe Length (Pre-Charge)		m	75 (20)	75 (20)
Height Difference		m	30	30
Operation Range	Cooling	°CDB	-5 to 46	-5 to 46
	Heating	°CDB	-15 to 24	-15 to 24
Refrigerant	Type (Global Warming Potential)		R410A (2,088)	R410A (2,088)
	Charge	g	11,200	11,200

Optional parts

Wired Remote Controller: UTY-RNNYM, UTY-RVNYM

Simple Remote Controller: UTY-RSNYM

Remote Sensor Unit: UTY-XSZX

Dimensions

(Unit : mm)

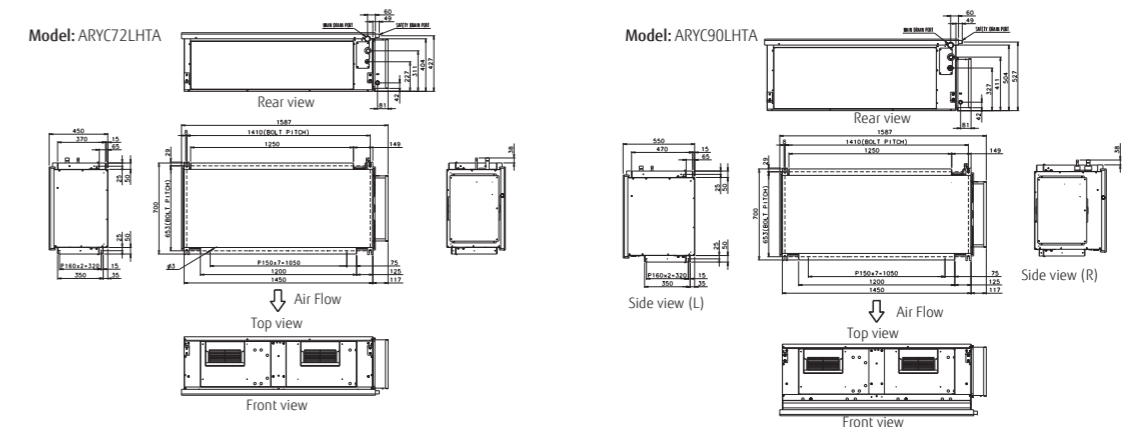

MULTI SPLIT



Control several indoor units
with one outdoor unit.
Build the optimum system you desire.

If you want to keep a large floor as well as many rooms comfortable, we recommend you use Multi Split to build a simple system using one outdoor unit. Choose from a large lineup of indoor units that best matches your rooms. You can mix and match them at will. Build the system that is just right for you.

Multi Split provides comfort in
a variety of situations

from home to
office and store.

- 092 2-8 Rooms Multi type Lineup
- 094 2 & 3-4 Rooms Multi
- 096 8 Rooms Multi
- 100 Specifications of All Indoor Units
- 102 Simultaneous Multi Twin/Triple
- 104 Multi Combination Table
- 114 Optional Parts for Split & Multi Split

2-8 Rooms Multi Type Lineup

		Indoor unit					
Model No.		14	18	24	30	45	
Cooling rated capacity(kw)		4	5	5.4	6.8	8	14
2 Rooms Multi Up to 2 units		●	●				
		AOYG14LAC2	AOYG18LAC2				
3 Rooms Multi Up to 3 units				●	●		
				AOYG18LAT3	AOYG24LAT3		
4 Rooms Multi Up to 4 units						●	
						AOYG30LAT4	
8 Rooms Multi Up to 8 units							●
							AOYG45LBT8

- Note : 1. 2 Rooms Multi : Connectable indoor units are 2 units.
 AOGY14LAC2: Total capacity of indoor units connected must be between 4.0 kW and 6.2 kW.
 AOGY18LAC2: Total capacity of indoor units connected must be between 4.0 kW and 7.0 kW.
2. 3 Rooms Multi : Connectable indoor units are 2 to 3 units.
 AOGY18LAT3: Total capacity of indoor units connected must be between 4.0 kW and 8.5 kW.
 AOGY24LAT3: Total capacity of indoor units connected must be between 4.0 kW and 10.5 kW.
3. 4 Rooms Multi : Connectable indoor units are 3 to 4 units.
 AOGY30LAT4: Total capacity of indoor units connected must be between 7.9 kW and 14.4 kW.
4. 8 Rooms Multi : Connectable indoor units are 2 to 8 units.
 AOGY45LBT8: Total capacity of indoor units connected must be between 11.2 kW and 18.2 kW.

Connectable Indoor unit line-up

Outdoor Unit	Type	2 Rooms		3 Rooms		4 Rooms	8 Rooms
	Model name	AOYG14LAC2	AOYG18LAC2	AOYG18LAT3	AOYG24LAT3	AOYG30LAT4	AOYG45LBT8
	Capacity (kW)						
		4.0	5.0	5.4	6.8	8.0	14.0
		4.4	5.6	6.8	8.0	9.6	16.0
Indoor Unit	BTU	kW Class					
	7000	2.0	●	●	●	●	●
	9000	2.5	●	●	●	●	●
	12000	3.5	●	●	●	●	●
	14000	4.0	—	●	●	●	●
	18000	5.0	—	—	—	●	●
	24000	7.0	—	—	—	●	●
	9000	2.5	—	●	●	●	●
	12000	3.5	—	●	●	●	●
	14000	4.0	—	—	●	●	●
	7000	2.0	—	●	●	●	●
	9000	2.5	—	●	●	●	●
	12000	3.5	—	●	●	●	●
	14000	4.0	—	—	●	●	●
	14000	4.0	—	—	●	●	●
	18000	5.0	—	—	—	●	●
	7000	2.0	—	●	●	●	●
	9000	2.5	—	●	●	●	●
	12000	3.5	—	●	●	●	●
	14000	4.0	—	—	●	●	●
	18000	5.0	—	—	—	●	●

Indoor unit features

	Economy	Powerful	HEAT	10°C	Auto	Up/Down	Deodor	Adjust	Restart	Dust	Intake	Sleep	Program	Weekly	+Senba	Fiber	ION	AF	Wash
ASYG07/09/12/14LM	●	●	●	●	●	●	●	●	●	●	●	●	●	●	○	●	●	●	●
ASYG07/09/12/14LU	●	●	●	●	●	●	●	●	●	●	●	●	●	●	○	●	●	●	●
ASYG18/24LF	●	●	●	●	●	●	●	●	●	●	●	●	●	●	○	●	●	●	●
AGYG09/12/14LV	●	●	●	●	●	●	●	●	●	●	●	●	●	●	○	●	●	●	●
AUYG07/09/12/14/18LV	●	●	●	●	●	●	●	●	●	○	○	●	●	●	○	●	●	●	●
ABYG14/18LV	●	●	●	●	●	●	●	●	●	○	○	●	●	●	○	●	●	●	●
ARYG07/09/12/14/18LL	●	○	●	○	●	●	●	●	●	○	○	○	○	○	●	●	●	●	●

○: Optional function

2 & 3-4 Rooms Multi



ALL DC

Features

Wide range of indoor units with various models

7 types 25 models are lined up in the capacity range from 2 kW to 7 kW class. Wide range of needs can be met from rooms of private homes to large shops and hotels.

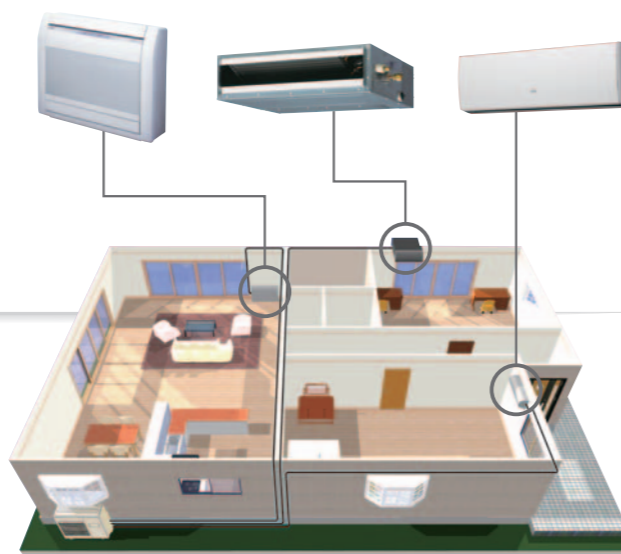

Space-saving installation

Multiple indoor units can be connected to 1 outdoor unit, and long piping connection is also possible. Compared with single type, the outdoor unit can be installed in various places to realize the space-saving installation.

Flexible installation

Up to max. piping length of 70 m (AOYG30LAT4), max. height difference of 15 m can be supported. Multi type can be installed at large-size residence or buildings with multiple floors.

Max. Piping Length (Each Unit):
 20 m (AOYG14LAC2 / 18LAC2),
 25 m (AOYG18LAT3 / 24LAT3 / 30LAT4)

Max. Height:
 15 m (AOYG14LAC2/18LAC2/18LAT3/24LAT3/30LAT4)

Total Piping Length:
 30 m (AOYG14LAC2 / 18LAC2),
 50 m (AOYG18LAT3 / 24LAT3),
 70 m (AOYG30LAT4)

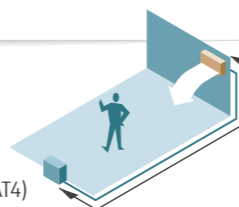

2 Rooms: AOYG14LAC2 / AOYG18LAC2
 3 Rooms: AOYG18LAT3 / AOYG24LAT3
 4 Rooms: AOYG30LAT4



Specifications (2 ROOMS, 3 ROOMS, 4 ROOMS)

Model No.	Outdoor unit	AOYG14LAC2	AOYG18LAC2	AOYG18LAT3	AOYG24LAT3	AOYG30LAT4
Power Source		Single-phase, ~230V, 50Hz				
Rated Capacity (min-max)	Cooling	4.0 (1.4-4.4)	5.0 (1.7-5.6)	5.4 (1.8-6.8)	6.8 (1.8-8.5)	8.0 (3.5-10.1)
	Heating	4.4 (1.1-5.4)	5.6 (1.8-6.1)	6.8 (2.0-8.0)	8.0 (2.0-8.8)	9.6 (3.7-12.0)
EER	Cooling	3.67	3.21	4.00	3.51	3.60
	Heating	4.27	3.97	4.20	4.00	4.00
Sound Pressure Level (High)	Cooling	47	50	46	48	50
	Heating	49	51	47	49	51
Sound Power Level (High)	Cooling	61	63	65	68	68
	Heating	63	64	67	70	70
Net Dimensions H × W × D	mm	540×790×290	540×790×290	700×900×330	700×900×330	830×900×330
Weight	kg(lbs)	37 (82)	38 (84)	55 (121)	55 (121)	68 (150)
Connection Pipe Diameter	Liquid	Ø6.35×2	Ø6.35×2	Ø6.35×3	Ø6.35×3	Ø6.35×4 (*Ø6.35×3, Ø9.52)
	Gas	9.52 × 2	9.52 × 2 *(9.52, 12.7)	9.52 × 2, 12.7 *(9.52 × 3)	9.52 × 2, 12.7 *(9.52 × 3)	9.52 × 2, 12.7 × 2 *(9.52 × 3, 12.7) *(9.52 × 2, 12.7, 15.88)
Max. Pipe Length	Total / Each	30 / 20	30 / 20	50 / 25	50 / 25	70 / 25
Max. Height Difference	Between Outdoor Unit and Each Indoor Units.	15	15	15	15	15
	Between Indoor Units.	10	10	10	10	10
Operation Range	Cooling	10 to 46	10 to 46	-10 to 46	-10 to 46	0 to 46
	Heating	-15 to 24	-15 to 24	-15 to 24	-15 to 24	-10 to 24
Refrigerant	Type (Global Warming Potential)	R410A (2,088)	R410A (2,088)	R410A (2,088)	R410A (2,088)	R410A (2,088)
	Charge	g	1,250	1,300	2,200	2,200

* Connect to connection valve by the adapter.

Dimensions

(Unit : mm)

2 Rooms:
 AOYG14LAC2/AOYG18LAC2

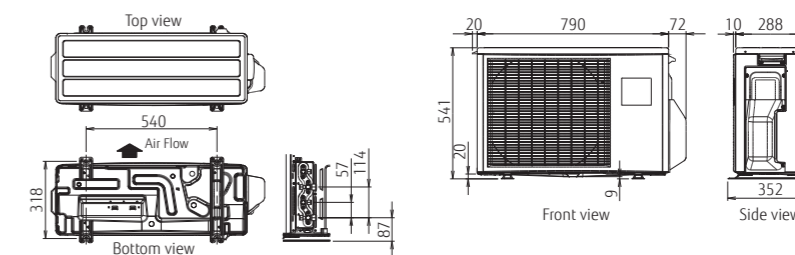

3 Rooms:
 AOYG18LAT3/AOYG24LAT3

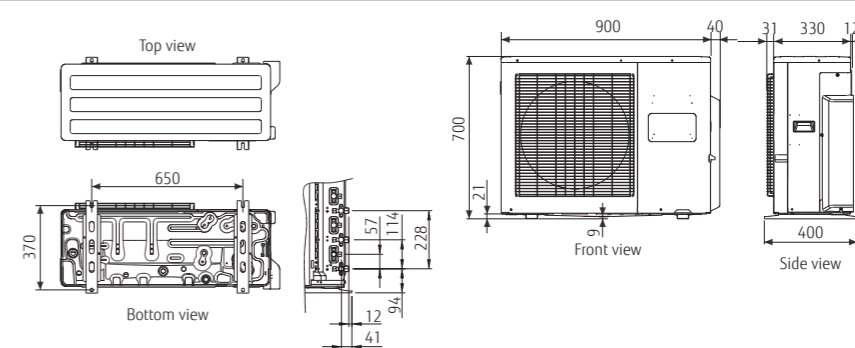

4 Rooms:
 AOYG30LAT4

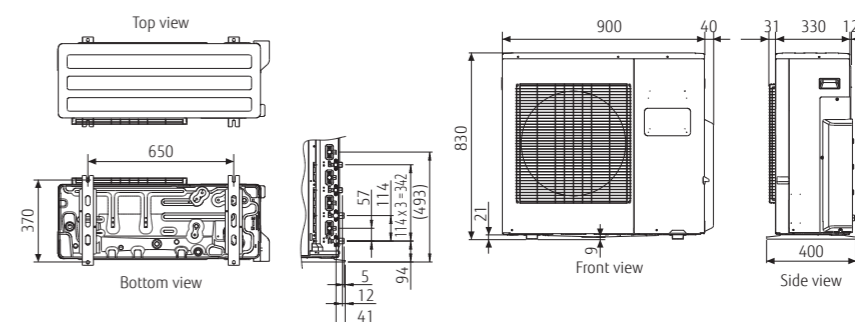

8 Rooms Multi



ALL DC

Features

Compact outdoor unit

The compact design outdoor unit allows to be installed below a window and in a narrow space.



High seasonal efficiency

The actual performance is conducted under various outside temperatures depending on weather and seasons, furthermore, especially for multi system, not all the rooms are operated all the time. So over 90% of actual operation time, air conditioners are operated at partial capacity instead of rated capacity. Considering these, we focused on energy-saving performance which is based on actual use. Efficiency of part load performance was drastically improved by developing ALL DC and our own inverter system.

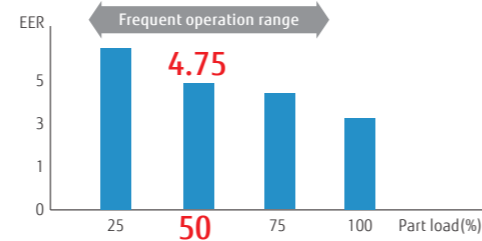

Innovated technology

High efficiency large fan:
New high efficiency fan is mounted.

DC fan motor:
High performance and high efficiency has been realized by using a small DC fan motor.

Heat exchanger:
Reduced compact size and energy saving has been realized by utilizing high density piping design and 3-Row heat exchanger.

High efficiency DC twin rotary compressor:
A high performance, low noise, large capacity DC twin rotary compressor is used.

Quick comfort by optimized refrigerant control

Every room meets the set point most quickly and comfortably by optimized refrigerant control.

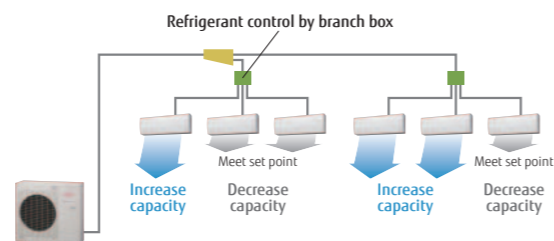

Central Remote Controller Option

Max. Controllable
1 multi system

Max. Controllable
8 indoor units

Central remote controller developed for residential applications. All indoor units can be batched controlled using simple operations. Schedule management and other functions can be used to achieve even greater energy savings.

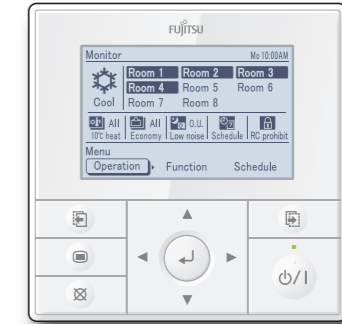

Central & Individual Control

Batched control of up to 8 indoor units. The temperature, airflow volume, and remote control prohibition settings of all indoor units can be batched.

Multiple language support

Corresponds to 9 different languages (English, German, French, Spanish, Russian, Portuguese, Italian, Greek, and Turkish)

Easy-To-Use operation

- Large backlight LED screen
- Large easy-to-see operation panel

System configuration

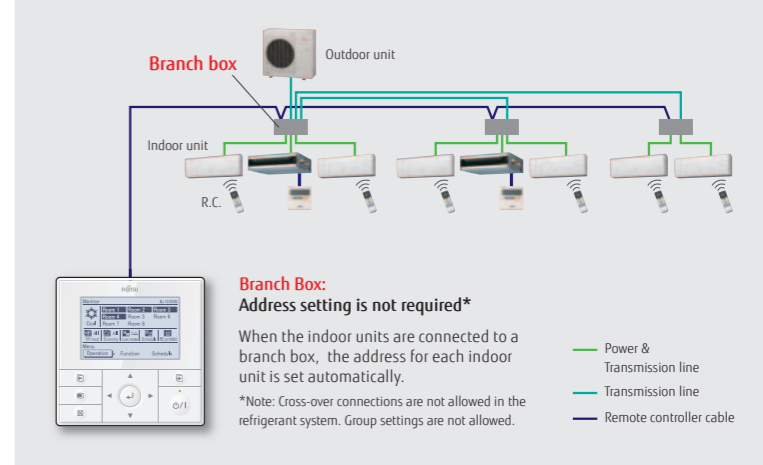

Central Remote Controller Functions

Weekly schedule timer

The ON/OFF setting can be set for 4 times a day. Two weekly patterns can be set to match the cooling and heating seasons.

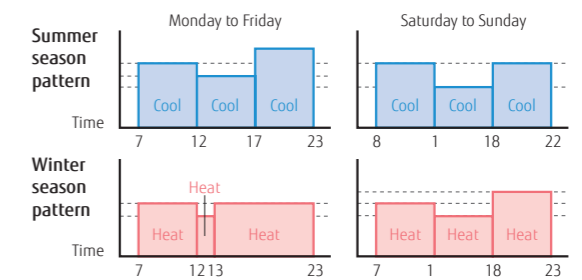

Low noise operation

Users can choose from 4 low noise levels, depending on the installation environment. The operation time can be set using the timer.

10°C heat operation

When you leave, minimum heating operation is performed to maintain the room temperature (maintain at 10°C).

Economy operation

Economy operation is energy saving, as the set temperature of indoor unit is shifted by 1°C and the maximum electric value of the outdoor unit is suppressed.

Prohibited Settings

The remote controller operation of all indoor units comes with a lock function to prevent unapproved operations in the various rooms. The central remote controller also has a key lock function to prevent children from playing with it, etc

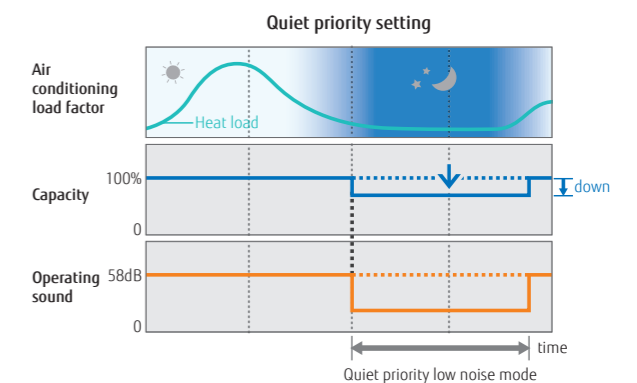

Large capacity connection

Up to 8 indoor units can be connected to one outdoor unit.
A maximum of 130% indoor unit connectable capacity.
Match any room layout.

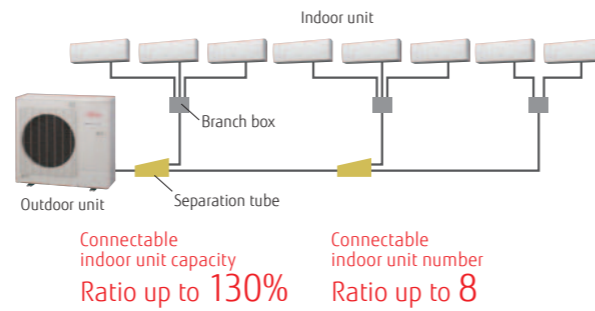

Long piping design

Can be installed in high rise condominiums or commercial buildings.

Total pipe length
Max. **115 m**

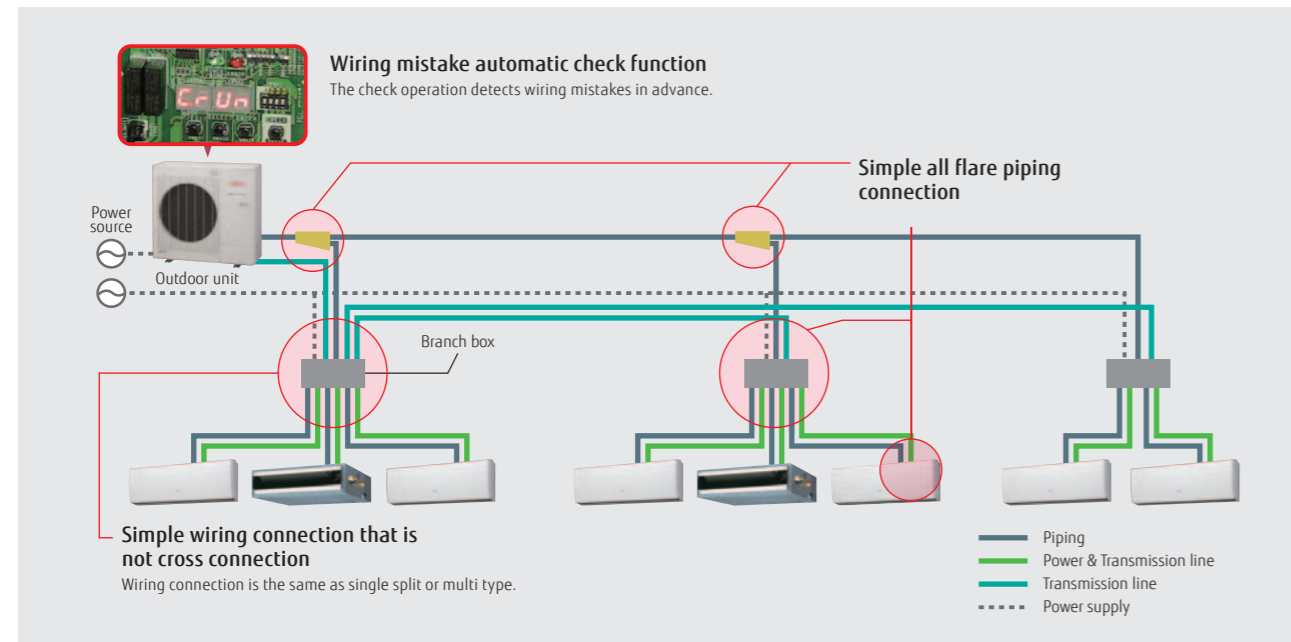
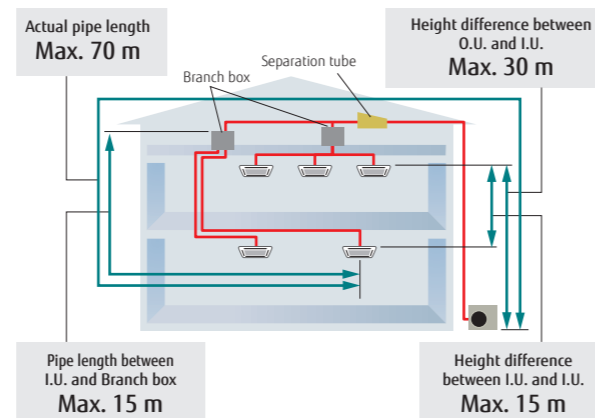

Branch Box can be mounted flexibly.

Allowed Branch Box Mounting Direction

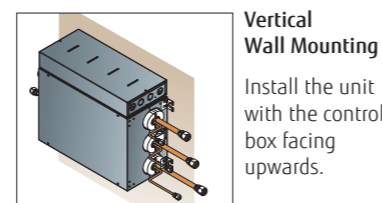
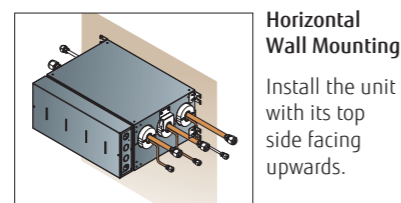
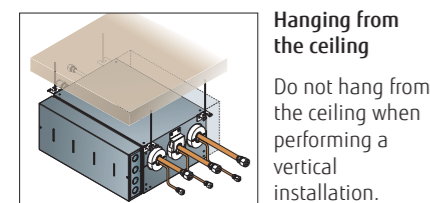

8 Rooms: AOYG45LBT8



Specifications

Model Name			AOYG45LBT8
Maximum Connectable Indoor Unit			8
Indoor Unit Connectable Capacit	Cooling	kW	11.2 - 18.2
Power source			Single-phase, ~230V, 50Hz
Rated Capacity	Cooling	kW	14.0
	Heating	kW	16.0
Input Power	Cooling	kW	5.20
	Heating	kW	5.07
Airflow rate	Cooling	m ³ /h	4,650
	Heating	m ³ /h	4,800
Sound Pressure Level	Cooling	dB(A)	56
	Heating	dB(A)	58
Heat Exchanger Fin			Plate fin coil
Net Dimensions H × W × D		mm	914 × 970 × 370
Weight		kg(lbs)	98 (217)
Connection Pipe Diameter (Liquid / Gas)			9.52/15.88
Max Pipe Length			115 (Total)
Max Height Difference (O.U. ~ I.U.)			30
Operating Range	Cooling	°CDB	-5 to 46
	Heating	°CDB	-15 to 24
Refrigerant	Type (Global Warming Potential)		R410A (2,088)
	Charge	g	3,450

Model Name			UTP-PY03A	UTP-PY02A
Connectable Indoor Unit			1 to 3 Units	1 to 2 Units
Power source			230/1/50	230/1/50
Available Voltage Range			198-264V	198-264V
Power Consumption			10 W	10
Running Current			0.05 A	0.05
Net Dimensions H × W × D			195 × 433 × 370	195 × 433 × 370
Weight			9 (20) kg(lbs)	9 (20)
Connection pipe diameter	Liquid	°CDB	Main: 9.52×1, Branch: 6.35×3	Main: 9.52×1, Branch: 6.35×2
	Gas	°CDB	Main: 15.88×1, Branch: 12.7×3	Main: 15.88×1, Branch: 12.7×2
Method			Flare	Flare

Note: Specifications are based on the following conditions.

- In case of connecting two indoor units (7 kW class).
- These are the measured values in the manufacturer's anechoic chamber.
- Cooling: Indoor temp. of 27°CDB/19°CWB, outdoor temp. of 35°CDB/24°CWB Heating: Indoor temp. of 20°CDB/15°CWB, outdoor temp. of 7°CDB/6°CWB
- Pipe length: 5m (Outdoor unit - Branch box), 3m (Branch box - Indoor unit) Height difference: 0m

Dimensions

(Unit : mm)

Outdoor Unit: AOYG45LBT8

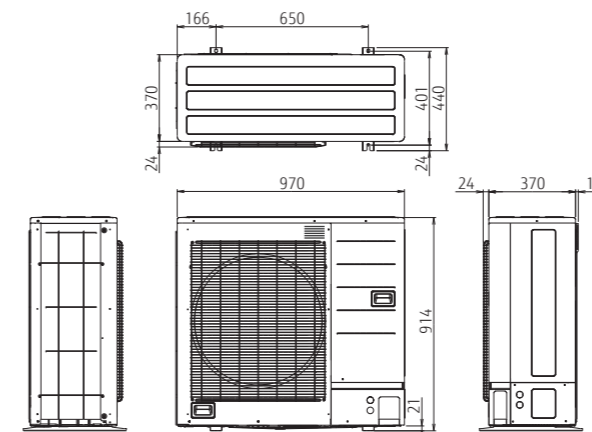

Branch Box : UTP-PY03A (3 branches type)

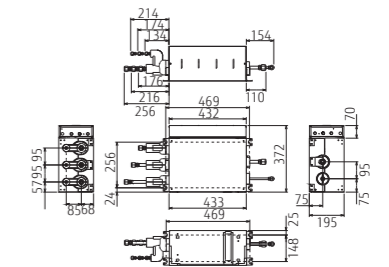

Branch Box : UTP-PY02A (2 branches type)

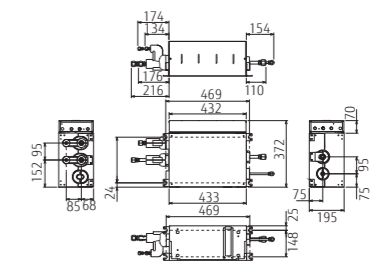

Specifications of All Indoor Units

Compact wall mounted



Model No.	Indoor unit		ASYG07LUCA	ASYG09LUCA	ASYG12LUCA	ASYG14LUCA	
kW Class	kW		2.0	2.5	3.5	4.0	
Power Source			Single-phase, ~230V, 50Hz				
Sound Pressure Level	Cooling	H/M/L/Q	dB(A)	35/30/28/21	36/32/28/21	37/34/31/21	41/36/33/25
	Heating			35/30/28/21	36/32/28/21	37/34/31/21	41/36/34/27
Sound Power Level	Cooling	H	dB(A)	53	54	55	59
	Heating			53	54	55	59
Airflow Rate	Cooling	H/M/L/Q	m³/h	570/520/470/330	600/550/470/330	660/600/530/330	710/640/570/390
	Heating			570/520/470/330	600/550/470/330	660/600/530/330	710/640/590/430
Net Dimensions			mm	282×870×185	282×870×185	282×870×185	282×870×185
Weight			kg(lbs)	9.5 (21)	9.5 (21)	9.5 (21)	9.5 (21)
Connection Pipe Diameter	Liquid/Gas		mm	6.35/9.52	6.35/9.52	6.35/9.52	6.35/12.7

Floor ceiling



Model No.	Indoor unit		ABYG14LVTA	ABYG14LUCA	
kW Class	kW		4.0	5.0	
Power Source			Single-phase, ~230V, 50Hz		
Sound Pressure Level	Cooling	H/M/L/Q	dB(A)	36/34/33/29 (Under ceiling) 39/37/36/32 (Floor console)	41/38/34/32 (Under ceiling) 44/41/37/35 (Floor console)
	Heating			36/34/33/29 (Under ceiling) 39/37/36/32 (Floor console)	41/38/34/32 (Under ceiling) 44/41/37/35 (Floor console)
Sound Power Level	Cooling	H	dB(A)	51	55
	Heating			51	55
Airflow Rate	Cooling	H/M/L/Q	m³/h	640/590/540/480	780/700/560/500
	Heating			640/590/540/480	780/700/560/500
Net Dimensions			mm	199×990×655	199×990×655
Weight			kg(lbs)	27 (60)	27 (60)
Connection Pipe Diameter	Liquid/Gas		mm	6.35/12.7	6.35/12.7

Wall mounted



Model No.	Indoor unit		ASYG07LMCA	ASYG09LMCA	ASYG12LMCA	ASYG14LMCA	ASYG18LFCA	ASYG24LFCC	
kW Class	kW		2.0	2.5	3.5	4.0	5.0	7.0	
Power Source			Single-phase, ~230V, 50Hz						
Sound Pressure Level	Cooling	H/M/L/Q	dB(A)	36/32/29/21	37/33/29/21	40/36/30/21	42/38/33/25	43/37/33/26	49/42/37/33
	Heating			36/32/29/22	37/33/29/22	40/36/31/22	42/38/35/27	42/37/33/25	48/42/37/33
Sound Power Level	Cooling	H	dB(A)	51	52	54	56	58	64
	Heating			51	52	55	57	58	64
Airflow Rate	Cooling	H/M/L/Q	m³/h	560/500/430/310	600/520/430/310	660/560/450/310	730/600/530/360	900/740/620/550	1120/900/740/620
	Heating			560/500/430/330	600/520/430/330	660/560/470/330	730/615/560/375	900/740/620/550	1100/900/740/620
Net Dimensions			mm	268×840×203	268×840×203	268×840×203	268×840×203	320×998×238	320×998×238
Weight			kg(lbs)	8.5 (19)	8.5 (19)	8.5 (19)	8.5 (19)	14 (30.8)	14 (30.8)
Connection Pipe Diameter	Liquid/Gas		mm	6.35/9.52	6.35/9.52	6.35/9.52	6.35/12.7	6.35/12.7	Ø6.35/Ø15.88

Compact cassette



Model No.	Indoor unit		AUYG07LVLA	AUYG09LVLA	AUYG12LVLB	AUYG14LVLB	AUYG18LVLB	
kW Class	kW		2.0	2.5	3.5	4.0	5.0	
Power Source			Single-phase, ~230V, 50Hz					
Sound Pressure Level	Cooling	H/M/L/Q	dB(A)	33/31/29/27	33/31/29/27	37/33/31/28	40/35/32/29	42/37/33/29
	Heating			34/32/29/27	34/32/29/27	37/33/31/28	40/37/34/29	44/40/37/30
Sound Power Level	Cooling	H	dB(A)	46	46	49	52	54
	Heating			47	47	49	52	56
Airflow Rate	Cooling	H/M/L/Q	m³/h	540/490/440/390	540/490/440/390	610/530/470/410	680/580/490/410	750/610/520/410
	Heating			540/490/440/390	540/490/440/390	610/530/470/410	700/620/550/430	800/710/600/450
Net Dimensions			mm	245×570×570	245×570×570	245×570×570	245×570×570	245×570×570
Weight			kg(lbs)	15 (33.1)	15 (33.1)	15 (33.1)	15 (33.1)	15 (33.1)
Panel				UTG-UFYD-W				
Connection Pipe Diameter	Liquid/Gas		mm	6.35/9.52	6.35/9.52	6.35/9.52	6.35/12.7	6.35/12.7

Floor



Model No.	Indoor unit		AGYG09LVCA	AGYG12LVCA	AGYG14LVCA	
kW Class	kW		2.5	3.5	4.0	
Power Source			Single-phase, ~230V, 50Hz			
Sound Pressure Level	Cooling	H/M/L/Q	dB(A)	39/34/28/22	42/36/30/22	44/38/31/22
	Heating			39/35/30/22	42/38/32/22	44/39/33/22
Sound Power Level	Cooling	H	dB(A)	52	55	56
	Heating			52	55	56
Airflow Rate	Cooling	H/M/L/Q	m³/h	530/440/360/270	600/490/380/270	650/520/400/270
	Heating			530/460/380/270	600/510/410/270	650/540/430/270
Net Dimensions			mm	600×740×200	600×740×200	600×740×200
Weight			kg(lbs)	14 (30.7)	14 (30.7)	14 (30.7)
Connection Pipe Diameter	Liquid/Gas		mm	6.35/9.52	6.35/9.52	6.35/12.7

Slim duct



Model No.	Indoor unit		ARYG07LLTA	ARYG09LLTA	ARYG12LLTB	ARYG14LLTB	ARYG18LLTB	
kW Class	kW		2.0	2.5	3.5	4.0	5.0	
Power Source			Single-phase, ~230V, 50Hz					
Sound Pressure Level	Cooling	H/M/L/Q	dB(A)	28/26/25/24	28/27/26/25	29/28/27/26	32/30/28/26	32/31/30/29
	Heating			28/26/25/24	28/26/25/24	29/28/27/24	33/30/28/25	33/32/31/29
Sound Power Level	Cooling	H	dB(A)	57	57	58	60	58
	Heating			57	57	58	61	59
Airflow Rate	Cooling	H/M/L/Q	m³/h	550/490/470/440	600/550/500/450	650/600/550/480	800/700/600/480	940/880/820/750
	Heating			550/490/470/440	600/550/500/450	650/600/550/480	800/700/600/480	940/880/820/750
Net Dimensions			mm	198×700×620	198×700×620	198×700×620	198×700×620	198×900×620
Weight			kg(lbs)	17 (37.5)	19 (41.8)	19 (41.8)	19 (41.8)	23 (50.6)
Connection Pipe Diameter	Liquid/Gas		mm	6.35/9.52	6.35/9.52	6.35/9.52	6.35/12.7	6.35/12.7
External static pressure				0 to 90				
Drain pump				Standard				

NEW

Simultaneous Multi Twin / Triple

ALL DC



Features

Can support various installation scenes from office to commercial space by same place multi connection of up to 3 units.

Indoor units distributed layout according to the shape and number of people and lighting conditions of the room even on wide floors and atypical floors. Ideal comfortable air flow distribution can be realized.

Installation according to floor layout

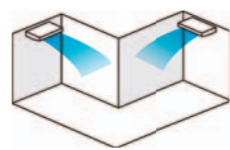

Installation according to lighting conditions

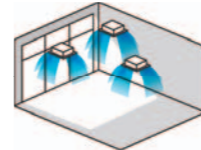

Installation according to layout and lighting conditions

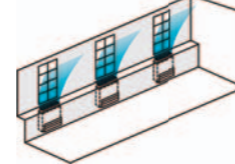

Simultaneous control

Max 16 indoor units are simultaneously controlled with a wired remote controller.

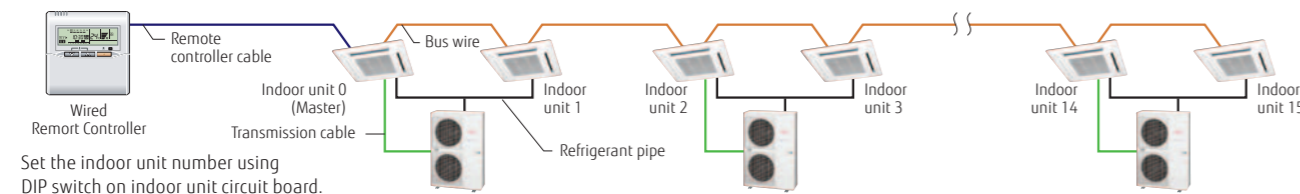

Simultaneous Operation Multi type Indoor Unit Line up

	Twin			Triple
	18x2	22x2	24x2	18x3
Cassette	AUYG18LV×2	AUYG22LV×2	AUYG24LV×2	AUYG18LV×3
Duct	ARYG18LL×2	ARYG22LM×2	ARYG24LM×2	ARYG18LL×3
Ceiling	ABYG18LV×2	ABYG22LV×2	ABYG24LV×2	ABYG18LV×3
Outdoor unit	AOYG36LBTB / AOYG36LATT	AOYG45LBTB / AOYG45LATT	AOYG54LBTB / AOYG54LATT	

Model : AOYG36LBTB / AOYG45LBTB / AOYG54LBTB **NEW**
 AOYG36LATT [3phase] / AOYG45LATT [3phase] / AOYG54LATT [3phase]



Specifications

Model No.	Indoor unit	Compact Cassette			
		AUYG18VLB	AUYG22VLA	AUYG24VLA	
Power Source		Single-phase, ~230V, 50Hz			
Airflow Rate (High)	Cooling H/M/L/Q	m ³ /h	680/580/490/410	930/830/600/450	930/830/600/450
Net Dimension H × W × D		mm	245×570×570	245×570×570	245×570×570
Weight		kg(lbs)	15 (33)	16 (35)	16 (35)
Cassette Grille			UTG-UFYD-W	UTG-UFYD-W	UTG-UFYD-W

Model No.	Indoor unit	Duct			Floor/Ceiling Universal		
		ARYG18LLT	ARYG22LMLA	ARYG24LMLA	ABYG18LVT	ABYG22LVT	ABYG24LVT
Power Source		Single-phase, ~230V, 50Hz			Single-phase, ~230V, 50Hz		
Airflow Rate (High)	Cooling H/M/L/Q	m ³ /h	1100/910/750/580	1100/910/750/580	780/700/560/500	980/820/680/540	980/820/680/540
Net Dimension H × W × D		mm	270 × 1135 × 700	270 × 1135 × 700	199 × 990 × 655	199 × 990 × 655	199 × 990 × 655
Weight		kg(lbs)	38 (84)	38 (84)	27 (60)	27 (60)	27 (60)

Model No.	Outdoor unit	AOYG36LBTB	AOYG45LBTB	AOYG54LBTB	AOYG36LATT	AOYG45LATT	AOYG54LATT
		Capacity	Cooling	10.0	12.1	13.3	10.0
	Heating	11.2	14.0	15.0	11.2	14.0	16.0
Power Source		Single-phase, ~230V, 50Hz			3-phase, ~400V, 50Hz		
Pdesign	Cooling	10.0	-	-	10.0	-	-
	Heating (-10°C)	10.0	-	-	10.0	-	-
SEER	Cooling	5.56	-	-	6.00	-	-
SCOP	Heating	3.90	-	-	4.00	-	-
Annual Energy Consumption	Cooling	629	-	-	583	-	-
	Heating	3588	-	-	3499	-	-
Energy Efficiency Class	Cooling	A	-	-	A+	-	-
	Heating	A	-	-	A+	-	-
Sound Pressure Level (High)	Cooling	52	54	55	51	54	55
	Heating	69	70	72	69	69	71
Net Dimension H × W × D		mm	1290×900×330	1290×900×330	1290×900×330	1290×900×330	1290×900×330
Weight		kg(lbs)	93(205)	93(205)	104 (229)	104 (229)	104 (229)
Connection Pipe Diameter (Liquid / Gas)		mm	9.52/15.88	9.52/15.88	9.52/15.88	9.52/15.88	9.52/15.88
Max Pipe Length (Pre-Charge)		m	75(30)	75(30)	75(30)	75(30)	75(30)
Height Difference		m	30	30	30	30	30
Operation Range	Cooling	*CDB	-15 to 46	-15 to 46	-15 to 46	-15 to 46	-15 to 46
	Heating		-15 to 24	-15 to 24	-15 to 24	-15 to 24	-15 to 24
Refrigerant	Type (Global Warming Potential)		R410A (2,088)	R410A (2,088)	R410A (2,088)	R410A (2,088)	R410A (2,088)
	Charge	g	3,450	3,450	3,450	3,450	3,450
Separation tube			UTP-SX236A(Twin)	UTP-SX254A(Twin)	UTP-SX254A(Twin)/UTP-SX354A(Triple)	UTP-SX236A(Twin)	UTP-SX254A(Twin)/UTP-SX354A(Triple)

*Different type and capacity indoor units can not be connected.
 *The above table is the value for connecting with cassette type.

Dimensions

(Unit : mm)

Outdoor Unit: AOYG36LBTB / AOYG36LATT / AOYG45LBTB / AOYG45LATT / AOYG54LBTB / AOYG54LATT

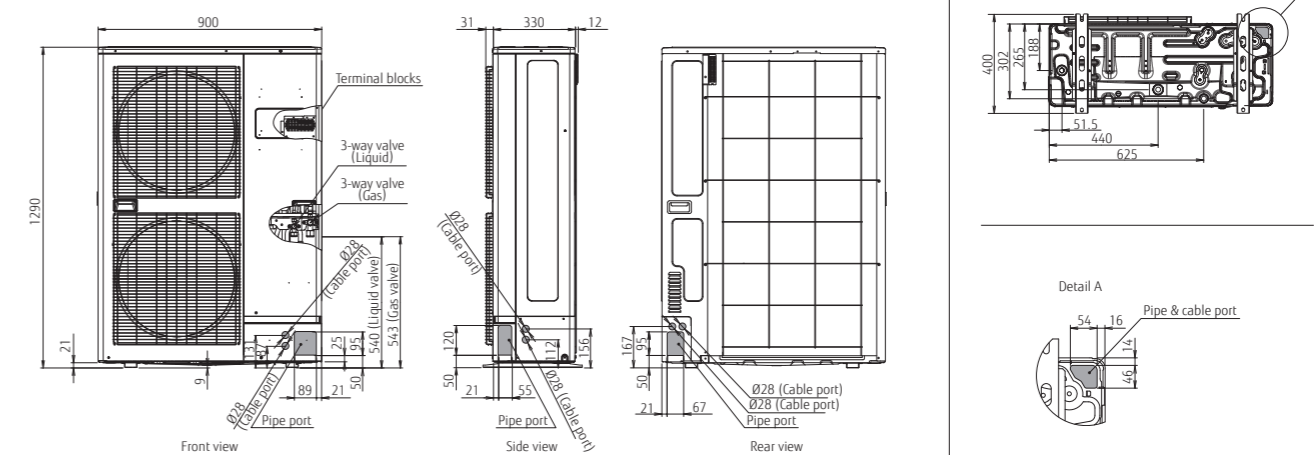

Multi Combination Table

2 Rooms Multi cooling

AOYG14LAC2	Combination of Indoor Unit		COOLING OPERATION									
			Cooling Capacity				Input Power (min-max)	EER	Seasonal Data			
			Room 1	Room 2	Total Capacity (min-max)	Pdesign			SEER	Energy efficiency class		
			kW	kW	kW	kW	kW					
2 Room	7	7	2.00	2.00	4.00 (1.4 - 4.4)	1.09 (0.35 - 1.40)	3.67	4.0	6.7	A++		
	7	9	1.95	2.05	4.00 (1.4 - 4.4)	1.09 (0.35 - 1.40)	3.67	4.0	6.6	A++		
	7	12	1.65	2.35	4.00 (1.4 - 4.6)	1.05 (0.35 - 1.47)	3.81	4.0	6.5	A++		
	9	9	2.00	2.00	4.00 (1.4 - 4.5)	1.09 (0.35 - 1.43)	3.67	4.0	6.6	A++		
	9	12	1.70	2.30	4.00 (1.4 - 4.7)	1.05 (0.35 - 1.47)	3.81	4.0	6.5	A++		

Note: •7:7000Btu/h / 9:9000Btu/h / 12:12000Btu/h models
 •The above is the value for connecting with Wall Mounted type.
 •2 or more indoor units should be connected.
 •Cooling capacity is based on 27°CDB/19°CWB (indoor temperature), 35°CDB (outdoor temperature).
 •Pipe Length: 5 m, Height difference: 0 m (Outdoor unit to Indoor unit)
 •The Total ability of connected a indoor unit is up to 21000Btu from 14000Btu.

AOYG18LAC2	Combination of Indoor Unit		COOLING OPERATION									
			Cooling Capacity				Input Power (min-max)	EER	Seasonal Data			
			Room 1	Room 2	Total Capacity (min-max)	Pdesign			SEER	Energy efficiency class		
			kW	kW	kW	kW	kW					
2 Room	7	7	2.10	2.10	4.20 (1.7 - 5.2)	1.24 (0.35 - 1.68)	3.39	4.2	7.0	A++		
	7	9	2.10	2.50	4.60 (1.7 - 5.3)	1.26 (0.35 - 1.79)	3.65	4.6	6.8	A++		
	7	12	1.90	3.10	5.00 (1.7 - 5.6)	1.55 (0.35 - 1.95)	3.23	5.0	6.5	A++		
	7	14	1.80	3.20	5.00 (1.8 - 5.7)	1.55 (0.40 - 1.99)	3.23	5.0	6.5	A++		
	9	9	2.50	2.50	5.00 (1.7 - 5.6)	1.56 (0.35 - 1.95)	3.21	5.0	6.6	A++		
	9	12	2.10	2.90	5.00 (1.7 - 5.7)	1.55 (0.35 - 1.95)	3.23	5.0	6.5	A++		
	9	14	2.00	3.00	5.00 (1.8 - 5.8)	1.55 (0.40 - 1.99)	3.23	5.0	6.4	A++		
	12	12	2.50	2.50	5.00 (1.7 - 5.8)	1.56 (0.35 - 1.99)	3.21	5.0	6.4	A++		

Note: •7:7000Btu/h / 9:9000Btu/h / 12:12000Btu/h / 14:14000Btu/h models
 •The above is the value for connecting with Wall Mounted type.
 •2 or more indoor units should be connected.
 •Cooling capacity is based on 27°CDB/19°CWB (indoor temperature), 35°CDB (outdoor temperature).
 •Pipe Length: 5 m, Height difference: 0 m (Outdoor unit to Indoor unit)
 •The Total ability of connected a indoor unit is up to 24000Btu from 14000Btu.
 •Where "14" means "wall mounted type" only models. Other types of indoor units can not be connected.

3 Rooms Multi cooling

AOYG18LAT3	Combination of Indoor Unit		COOLING OPERATION										
			Cooling Capacity				Input Power (min-max)	EER	Seasonal Data				
			Room 1	Room 2	Room 3	Total Capacity (min-max)			Pdesign	SEER	Energy efficiency class		
			kW	kW	kW	kW	kW						
2 Room	7	7	-	2.30	2.30	-	4.60 (1.8 - 5.0)	1.22 (0.50 - 1.43)	3.77	4.6	6.3	A++	
	7	9	-	2.30	2.70	-	5.00 (1.8 - 5.7)	1.35 (0.50 - 1.81)	3.70	5.0	6.2	A++	
	7	12	-	1.98	3.02	-	5.00 (1.8 - 6.1)	1.34 (0.50 - 2.06)	3.73	5.0	6.2	A++	
	7	14	-	1.88	3.42	-	5.30 (1.8 - 6.6)	1.34 (0.50 - 2.06)	3.96	5.3	6.1	A++	
	9	9	-	2.50	2.50	-	5.00 (1.8 - 6.2)	1.35 (0.50 - 2.06)	3.70	5.0	6.2	A++	
	9	12	-	2.18	2.82	-	5.00 (1.8 - 6.3)	1.35 (0.50 - 2.06)	3.70	5.0	6.2	A++	
	9	14	-	2.07	3.23	-	5.30 (1.8 - 6.7)	1.35 (0.50 - 2.06)	3.93	5.3	6.1	A++	
	12	12	-	2.55	2.55	-	5.10 (1.8 - 6.3)	1.35 (0.50 - 2.06)	3.78	5.1	6.1	A++	
	12	14	-	2.41	2.89	-	5.30 (1.8 - 6.7)	1.35 (0.50 - 2.06)	3.93	5.3	6.1	A++	
	3 Room	7	7	7	1.80	1.80	1.80	5.40 (1.8 - 6.8)	1.35 (0.50 - 2.06)	4.00	5.4	6.9	A++
		7	7	9	1.70	1.70	2.00	5.40 (1.8 - 6.8)	1.35 (0.50 - 2.06)	4.00	5.4	6.9	A++
		7	7	12	1.53	1.53	2.33	5.40 (1.8 - 6.8)	1.35 (0.50 - 2.06)	4.00	5.4	6.7	A++
7		7	14	1.41	1.41	2.58	5.40 (2.0 - 6.8)	1.35 (0.60 - 2.06)	4.00	5.4	6.7	A++	
7		9	9	1.61	1.89	1.89	5.40 (1.8 - 6.8)	1.35 (0.50 - 2.06)	4.00	5.4	6.8	A++	
7		9	12	1.46	1.72	2.22	5.40 (1.8 - 6.8)	1.35 (0.50 - 2.06)	4.00	5.4	6.7	A++	
7		9	14	1.35	1.58	2.47	5.40 (2.0 - 6.8)	1.35 (0.60 - 2.06)	4.00	5.4	6.7	A++	
9		9	9	1.80	1.80	1.80	5.40 (1.8 - 6.8)	1.35 (0.50 - 2.06)	4.00	5.4	6.8	A++	
9		9	12	1.64	1.64	2.12	5.40 (1.8 - 6.8)	1.35 (0.50 - 2.06)	4.00	5.4	6.7	A++	

AOYG24LAT3	Combination of Indoor Unit		COOLING OPERATION									
			Cooling Capacity				Input Power (min-max)	EER	Seasonal Data			
			Room 1	Room 2	Room 3	Total Capacity (min-max)			Pdesign	SEER	Energy efficiency class	
			kW	kW	kW	kW	kW					
2 Room	7	7	-	2.30	2.30	-	4.60 (1.8 - 5.0)	1.20 (0.50 - 1.40)	3.83	4.6	6.3	A++
	7	9	-	2.30	2.70	-	5.00 (1.8 - 5.7)	1.36 (0.50 - 1.78)	3.68	5.0	6.2	A++
	7	12	-	2.38	3.42	-	5.80 (1.8 - 6.1)	1.70 (0.50 - 1.97)	3.41	5.8	6.1	A++
	7	14	-	2.37	4.13	-	6.50 (1.8 - 7.2)	1.91 (0.50 - 2.46)	3.40	6.5	6.0	A+
	9	12	-	2.08	4.52	-	6.60 (1.8 - 7.8)	1.91 (0.50 - 2.87)	3.46	6.6	5.9	A+
	9	9	-	2.75	2.75	-	5.30 (1.8 - 6.2)	1.35 (0.50 - 2.06)	3.55	5.3	6.1	A++
	9	12	-	2.79	3.41	-	6.20 (1.8 - 6.8)	1.90 (0.50 - 2.45)	3.26	6.2	5.9	A+
	9	14	-	2.66	3.94	-	6.60 (1.8 - 7.7)	1.91 (0.50 - 2.77)	3.46	6.6	6.0	A+
	9	18	-	2.35	4.35	-	6.70 (1.8 - 7.9)	1.91 (0.50 - 2.87)	3.51	6.7	5.9	A+
	12	12	-	3.15	3.15	-	6.30 (1.8 - 7.2)	1.90 (0.50 - 2.74)	3.32	6.3	5.9	A+
	12	14	-	3.03	3.67	-	6.70 (1.8 - 7.8)	1.91 (0.50 - 2.87)	3.51	6.7	5.9	A+
	12	18	-	2.66	4.04	-	6.70 (1.8 - 7.9)	1.92 (0.50 - 2.87)	3.49	6.7	5.8	A+
3 Room	7	7	7	2.23	2.23	2.23	6.70 (1.8 - 7.4)	1.89 (0.50 - 2.37)	3.54	6.7	6.4	A++
	7	7	9	2.14	2.14	2.52	6.80 (1.8 - 7.8)	1.94 (0.60 - 2.87)	3.51	6.8	6.4	A++
	7	7	12	1.98	1.98	2.84	6.80 (1.8 - 8.1)	1.93 (0.50 - 2.87)	3.52	6.8	6.3	A++
	7	7	14	1.82	1.82	3.16	6.80 (2.0 - 8.4)	1.94 (0.60 - 2.87)	3.51	6.8	6.2	A++
	7	7	18	1.63	1.63	3.54	6.80 (2.0 - 8.5)	1.94 (0.60 - 2.87)	3.51	6.8	6.1	A++
	7	9	9	2.03	2.38	2.38	6.80 (1.8 - 8.2)	1.93 (0.50 - 2.87)	3.52	6.8	6.4	A++
	7	9	12	1.88	2.21	2.70	6.80 (1.8 - 8.2)	1.93 (0.50 - 2.87)	3.52	6.8	6.2	A++
	7	9	14	1.74	2.04	3.02	6.80 (2.0 - 8.4)	1.94 (0.60 - 2.87)	3.51	6.8	6.2	A++
	7	9	18	1.56	1.84	3.40	6.80 (2.0 - 8.5)	1.94 (0.60 - 2.87)	3.51	6.8	6.1	A++
	7	12	12	1.76	2.52	2.52	6.80 (1.8 - 8.2)	1.94 (0.50 - 2.87)	3.51	6.8	6.2	A++
	7	12	14	1.63	2.34	2.83	6.80 (2.0 - 8.5)	1.94 (0.60 - 2.87)	3.51	6.8	6.2	A++
	9	9	9	2.27	2.27	2.27	6.80 (1.8 - 8.2)	1.94 (0.50 - 2.87)	3.51	6.8	6.4	A++
	9	9	12	2.11	2.11	2.58	6.80 (1.8 - 8.3)	1.94 (0.50 - 2.87)	3.51	6.8	6.2	A++
	9	9	14	1.95	1.95	2.89	6.80 (2.0 - 8.5)	1.94 (0.60 - 2.87)	3.51	6.8	6.2	A++
	9	9	18*	1.77	1.77	3.27	6.80 (2.0 - 8.5)	1.94 (0.60 - 2.87)	3.51	6.8	6.1	A++
	9	12	12	1.97	2.41	2.41	6.80 (1.8 - 8.3)	1.94 (0.50 - 2.87)	3.51	6.8	6.2	A++
	9	12	14	1.84	2.24	2.72	6.80 (2.0 - 8.5)	1.94 (0.60 - 2.87)	3.51	6.8	6.2	A++
	12	12	12	2.27	2.27	2.27	6.80 (1.8 - 8.3)	1.94 (0.50 - 2.87)	3.51	6.8	6.1	A++

Note: •7:7000Btu/h / 9:9000Btu/h / 12:12000Btu/h / 14:14000Btu/h / 18:18000Btu/h models
 •The above is the value for connecting with Wall Mounted type.
 •2 or more indoor units should be connected.
 •Cooling capacity is based on 27°CDB/19°CWB (indoor temperature), 35°CDB (outdoor temperature).
 •Pipe Length: 5 m, Height difference: 0 m (Outdoor unit to Indoor unit)
 •The total ability of connectable indoor units is up to 36000Btu from 14000Btu.
 *1: When ASYG18L is connected, connect at least 1 wall mounted type of 9000Btu.

2 Rooms Multi heating

AOYG14LAC2	Combination of Indoor Unit		HEATING OPERATION									
			Heating Capacity				Input Power (min-max)	EER	Seasonal Data			
			Room 1	Room 2	Total Capacity (min-max)	Pdesign			SEER	Energy efficiency class		
			kW	kW	kW	kW	kW					
2 Room	7	7	2.20	2.20	4.40 (1.1 - 5.4)	1.03 (0.25 - 1.78)	4.27	3.8	4.1	A+		
	7	9	2.15	2.25	4.40 (1.1 - 5.4)	1.03 (0.25 - 1.78)	4.27	3.8	4.1	A+		
	7	12	1.95	2.45	4.40 (1.1 - 5.5)	1.02 (0.25 - 1.76)	4.31	3.8	4.0	A+		
	9	9	2.20	2.20	4.40 (1.1 - 5.4)	1.03 (0.25 - 1.78)	4.27	3.8	4.0	A+		
	9	12	2.00	2.40	4.40 (1.1 - 5.5)	1.02 (0.25 - 1.76)	4.31	3.8	4.0	A+		

Note: •7:7000Btu/h / 9:9000Btu/h / 12:12000Btu/h models
 •The above is the value for connecting with Wall Mounted type.
 •2 or more indoor units should be connected.
 •Heating capacity is based on 20°CDB (indoor temperature), 7°CDB/6°CWB (outdoor temperature).
 •Pipe Length: 5 m, Height difference: 0 m (Outdoor unit to Indoor unit)
 •The Total ability of connected a indoor unit is up to 21000Btu from 14000Btu.

AOYG18LAC2	Combination of Indoor Unit		HEATING OPERATION									
			Heating Capacity				Input Power (min-max)	EER	Seasonal Data			
			Room 1	Room 2	Total Capacity (min-max)	Pdesign			SEER	Energy efficiency class		
			kW	kW	kW	kW	kW					
2 Room	7	7	2.70	2.70	5.40 (1.8 - 6.0)	1.24 (0.50 - 1.61)	4.37	3.8	4.1	A+		
	7	9	2.50	3.00	5.50 (1.8 - 6.0)	1.36 (0.50 - 1.87)	4.04	4.0	4.1	A+		
	7	12	2.30	3.30	5.60 (1.8 - 6.1)	1.38 (0.50 - 1.88)	4.06	4.2	4.0	A+		
	7	14	2.25	3.35	5.60 (1.9 - 6.2)	1.35 (0.55 - 1.86)	4.15	4.2	4.0	A+		
	9	9	2.80	2.80	5.60 (1.8 - 6.1)	1.41 (0.50 - 1.90)	3.97	4.2	4.1	A+		
	9	12	2.45	3.15	5.60 (1.8 - 6.2)	1.38 (0.50 - 1.88)	4.07	4.2	4.0	A+		
	9	14	2.35	3.25	5.60 (1.9 - 6.3)	1.35 (0.55 - 1.86)	4.15	4.2	4.0	A+		
	12	12	2.80	2.80	5.60 (1.8 - 6.3)	1.34 (0.50 - 1.84)	4.18	4.2	4.0	A+		

Note: •7:7000Btu/h / 9:9000Btu/h / 12:12000Btu/h / 14:14000Btu/h models
 •The above is the value for connecting with Wall Mounted type.
 •2 or more indoor units should be connected.
 •Heating capacity is based on 20°CDB (indoor temperature), 7°CDB/6°CWB (outdoor temperature).
 •Pipe Length: 5 m, Height difference: 0 m (Outdoor unit to Indoor unit)
 •The Total ability of connected a indoor unit is up to 24000Btu from 14000Btu.
 •Where "14" means "wall mounted type" only models. Other types of indoor units can not be connected.

3 Rooms

4 Rooms Multi cooling

AOYG30LAT4	Combination of Indoor Unit		COOLING OPERATION							Seasonal Data			
			Cooling Capacity				Input Power (min-max)	EER	Pdesign	Energy			
			Room 1	Room 2	Room 3	Room 4				Total Capacity (min-max)	SEER	efficiency class	
		kW	kW	kW	kW	kW	kW	kW					
7	7	14	-	1.96	1.96	3.27	-	7.20 (1.6-8.9)	2.22 (0.68-3.43)	3.24	7.2	5.9	A+
7	7	18	-	1.81	1.81	4.08	-	7.70 (2.8-10.0)	2.22 (0.98-3.55)	3.47	7.7	5.8	A+
7	7	24	-	1.61	1.61	4.57	-	7.80 (2.8-10.1)	2.19 (0.98-3.53)	3.56	7.8	5.8	A+
7	9	12	-	2.08	2.34	2.78	-	7.20 (1.6-8.9)	2.22 (0.68-3.41)	3.24	7.2	5.9	A+
7	9	14	-	1.90	2.14	3.16	-	7.20 (2.8-9.1)	2.22 (0.98-3.56)	3.24	7.2	5.9	A+
7	9	18	-	1.76	1.98	3.96	-	7.70 (2.8-9.9)	2.22 (0.98-3.56)	3.47	7.7	5.8	A+
7	9	24	-	1.57	1.77	4.46	-	7.80 (2.8-10.1)	2.19 (0.98-3.53)	3.56	7.8	5.8	A+
7	12	12	-	1.96	2.62	2.62	-	7.20 (1.6-8.9)	2.22 (0.68-3.54)	3.24	7.2	5.9	A+
7	12	14	-	1.83	2.43	3.04	-	7.30 (2.8-9.2)	2.22 (0.98-3.56)	3.29	7.3	5.9	A+
7	12	18	-	1.68	2.24	3.78	-	7.70 (2.8-9.9)	2.22 (0.98-3.56)	3.47	7.7	5.8	A+
7	12	24	-	1.51	2.01	4.28	-	7.80 (2.8-10.1)	2.19 (0.98-3.56)	3.56	7.8	5.8	A+
7	14	14	-	1.68	2.81	2.81	-	7.30 (2.8-9.3)	2.22 (0.98-3.58)	3.29	7.3	5.9	A+
7	14	18	-	1.57	2.61	3.52	-	7.70 (3.5-10.0)	2.22 (1.17-3.58)	3.47	7.7	5.8	A+
7	14	24	-	1.44	2.39	4.07	-	7.90 (3.5-10.1)	2.20 (1.17-3.58)	3.59	7.9	5.8	A+
7	18	18	-	1.42	3.19	3.19	-	7.80 (3.5-10.1)	2.22 (1.17-3.58)	3.51	7.8	5.7	A+
7	18	24	-	1.30	2.92	3.68	-	7.90 (4.7-10.1)	2.22 (1.27-3.58)	3.56	7.9	5.7	A+
9	9	9	-	2.40	2.40	2.40	-	7.20 (2.8-8.9)	2.22 (0.98-3.42)	3.24	7.2	5.9	A+
9	9	12	-	2.26	2.26	2.68	-	7.20 (2.8-9.1)	2.22 (0.98-3.54)	3.24	7.2	5.9	A+
9	9	14	-	2.10	2.10	3.11	-	7.30 (2.8-9.2)	2.22 (0.98-3.57)	3.29	7.3	5.9	A+
9	9	18	-	1.93	1.93	3.85	-	7.70 (2.8-9.9)	2.22 (0.98-3.56)	3.47	7.7	5.8	A+
9	9	24	-	1.73	1.73	4.35	-	7.80 (2.8-10.1)	2.20 (1.17-3.54)	3.55	7.8	5.8	A+
9	12	12	-	2.14	2.53	2.53	-	7.20 (2.8-9.1)	2.22 (0.98-3.54)	3.24	7.2	5.9	A+
9	12	14	-	1.99	2.36	2.95	-	7.30 (2.8-9.2)	2.22 (0.98-3.57)	3.29	7.3	5.9	A+
9	12	18	-	1.84	2.18	3.68	-	7.70 (2.8-9.9)	2.22 (0.98-3.56)	3.47	7.7	5.8	A+
9	12	24	-	1.66	1.97	4.78	-	7.80 (2.8-10.1)	2.19 (0.98-3.56)	3.56	7.8	5.8	A+
9	14	14	-	1.84	2.73	2.73	-	7.30 (3.5-9.3)	2.22 (1.17-3.58)	3.29	7.3	5.9	A+
9	14	18	-	1.74	2.58	3.48	-	7.80 (3.5-10.0)	2.22 (1.17-3.58)	3.51	7.8	5.8	A+
9	14	24	-	1.58	2.34	3.98	-	7.90 (3.5-10.1)	2.22 (1.27-3.56)	3.56	7.9	5.8	A+
9	18	18	-	1.56	3.12	3.12	-	7.80 (4.7-10.1)	2.22 (1.27-3.58)	3.51	7.8	5.7	A+
12	12	12	-	2.43	2.43	2.43	-	7.30 (2.8-9.2)	2.22 (0.98-3.55)	3.29	7.3	5.9	A+
12	12	14	-	2.28	2.28	2.85	-	7.40 (2.8-9.3)	2.22 (0.98-3.58)	3.33	7.4	5.9	A+
12	12	18	-	2.12	2.12	3.57	-	7.80 (3.5-10.0)	2.22 (1.17-3.57)	3.51	7.8	5.8	A+
12	12	24	-	1.92	1.92	4.07	-	7.90 (3.5-10.1)	2.20 (1.17-3.54)	3.59	7.9	5.8	A+
12	14	14	-	2.11	2.64	2.64	-	7.40 (3.5-9.4)	2.22 (1.17-3.58)	3.33	7.4	5.9	A+
12	14	18	-	1.98	2.48	3.34	-	7.80 (3.5-10.1)	2.22 (1.17-3.58)	3.51	7.8	5.8	A+
12	18	18	-	1.81	3.05	3.05	-	7.90 (4.7-10.1)	2.22 (1.27-3.58)	3.56	7.9	5.7	A+
7	7	7	7	1.93	1.93	1.93	1.93	7.70 (1.6-9.6)	2.20 (0.68-3.41)	3.50	7.7	6.2	A++
7	7	7	9	1.89	1.89	1.89	2.13	7.80 (1.6-9.8)	2.22 (0.68-3.54)	3.51	7.8	6.2	A++
7	7	7	12	1.83	1.83	1.83	2.41	7.90 (1.6-9.9)	2.22 (0.68-3.54)	3.56	7.9	6.1	A++
7	7	7	14	1.70	1.70	1.70	2.80	7.90 (2.8-9.9)	2.22 (0.98-3.56)	3.56	7.9	6.1	A++
7	7	7	18	1.52	1.52	1.52	3.43	8.00 (2.8-10.1)	2.20 (0.98-3.55)	3.64	8.0	6.0	A++
7	7	9	9	1.86	1.86	2.09	2.09	7.90 (2.8-9.7)	2.22 (0.98-3.42)	3.56	7.9	6.2	A++
7	7	9	12	1.78	1.78	1.99	2.35	7.90 (2.8-9.9)	2.22 (0.98-3.55)	3.56	7.9	6.1	A++
7	7	9	14	1.68	1.68	1.88	2.76	8.00 (2.8-10.0)	2.22 (0.98-3.57)	3.60	8.0	6.1	A++
7	7	9	18	1.49	1.49	1.67	3.35	8.00 (3.5-10.1)	2.20 (1.17-3.55)	3.64	8.0	6.0	A++
7	7	12	12	1.72	1.72	2.28	2.28	8.00 (2.8-10.0)	2.22 (0.98-3.55)	3.60	8.0	6.1	A++
7	7	12	14	1.61	1.61	2.13	2.65	8.00 (2.8-10.0)	2.22 (0.98-3.57)	3.60	8.0	6.1	A++
7	7	12	18	1.43	1.43	1.91	3.22	8.00 (3.5-10.1)	2.20 (1.17-3.56)	3.64	8.0	6.0	A++
7	7	14	14	1.50	1.50	2.50	2.50	8.00 (3.5-10.1)	2.22 (1.17-3.58)	3.60	8.0	6.0	A++
7	7	14	18	1.35	1.35	2.25	3.04	8.00 (3.5-10.1)	2.22 (1.17-3.58)	3.60	8.0	6.0	A++
7	9	9	9	1.81	2.03	2.03	2.03	7.90 (2.8-9.9)	2.22 (0.98-3.56)	3.56	7.9	6.2	A++
7	9	9	12	1.76	1.96	1.96	2.32	8.00 (2.8-10.0)	2.22 (0.98-3.56)	3.60	8.0	6.1	A++
7	9	9	14	1.64	1.83	1.83	2.70	8.00 (3.5-10.1)	2.22 (1.17-3.58)	3.60	8.0	6.1	A++
7	9	9	18	1.45	1.64	1.64	3.27	8.00 (3.5-10.1)	2.22 (1.17-3.56)	3.60	8.0	6.0	A++
7	9	12	12	1.68	1.88	2.22	2.22	8.00 (2.8-10.0)	2.22 (0.98-3.56)	3.60	8.0	6.1	A++
7	9	12	14	1.57	1.76	2.08	2.59	8.00 (3.5-10.1)	2.22 (1.17-3.58)	3.60	8.0	6.0	A++
7	9	12	18	1.40	1.58	1.87	3.15	8.00 (3.5-10.1)	2.22 (1.17-3.56)	3.60	8.0	6.0	A++
7	9	14	14	1.48	1.66	2.43	2.43	8.00 (3.5-10.1)	2.22 (1.17-3.58)	3.60	8.0	6.0	A++
7	9	14	18	1.32	1.49	2.21	2.98	8.00 (4.7-10.1)	2.22 (1.27-3.57)	3.60	8.0	6.0	A++
7	12	12	12	1.61	2.13	2.13	2.13	8.00 (2.8-10.1)	2.22 (0.98-3.56)	3.60	8.0	6.0	A++
7	12	12	14	1.51	2.00	2.00	2.49	8.00 (3.5-10.1)	2.22 (1.17-3.58)	3.60	8.0	6.0	A++
7	12	12	18	1.35	1.80	1.80	3.04	8.00 (3.5-10.1)	2.22 (1.17-3.56)	3.60	8.0	6.0	A++
7	12	14	14	1.41	1.89	2.35	2.35	8.00 (3.5-10.1)	2.22 (1.17-3.58)	3.60	8.0	6.0	A++
9	9	9	9	2.00	2.00	2.00	2.00	8.00 (3.5-10.0)	2.22 (1.17-3.56)	3.60	8.0	6.2	A++
9	9	9	12	1.91	1.91	1.91	2.27	8.00 (3.5-10.0)	2.22 (1.17-3.56)	3.60	8.0	6.1	A++
9	9	9	14	1.79	1.79	1.79	2.63	8.00 (3.5-10.0)	2.22 (1.17-3.56)	3.60	8.0	6.0	A++
9	9	9	18**	1.60	1.60	1.60	3.20	8.00 (4.7-10.0)	2.22 (1.17-3.56)	3.60	8.0	6.0	A++
9	9	12	12	1.83	1.83	2.17	2.17	8.00 (3.5-10.0)	2.22 (1.17-3.56)	3.60	8.0	6.0	A++
9	9	12	14	1.72	1.72	2.03	2.53	8.00 (3.5-10.0)	2.22 (1.17-3.56)	3.60	8.0	6.0	A++
9	9	12	18**	1.54	1.54	1.83	3.09	8.00 (4.7-10.0)	2.22 (1.17-3.56)	3.60	8.0	6.0	A++
9	9	14	14	1.62	1.62	2.38	2.38	8.00 (4.7-10.0)	2.22 (1.17-3.56)	3.60	8.0	6.0	A++
9	12	12	12	1.76	2.08	2.08	2.08	8.00 (3.5-10.0)	2.22 (1.17-3.56)	3.60	8.0	6.0	A++
9	12	12	14	1.66	1.95	1.95	2.44	8.00 (3.5-10.0)	2.22 (1.17-3.56)	3.60	8.0	6.0	A++
9	12	14	14	1.55	1.85	2.30	2.30	8.00 (4.7-10.0)	2.22 (1.17-3.56)	3.60	8.0	6.0	A++
12	12	12	12	2.00	2.00	2.00	2.00	8.00 (3.5-10.0)	2.22 (1.17-3.56)	3.60	8.0	6.0	A++

Note: *7:7000Btu/h / 9:9000Btu/h / 12:12000Btu/h / 14:14000Btu/h / 18:18000Btu/h / 24:24000Btu/h models
 •The above is the value for connecting with Wall Mounted type.
 •3 or more indoor units should be connected.
 •Cooling capacity is based on 27°CDB/19°CWB (indoor temperature), 35°CDB (outdoor temperature).
 •Pipe Length: 5 m, Height difference: 0 m (Outdoor unit to Indoor unit)
 •The Total ability of connected a indoor unit is up to 49000Btu from 27000Btu.
 *1: Connection of ASYG18L + ARYG09L + ARYG09L + ARYG09L is not available. All types other than this combination can be connected.
 *2: Connection of ASYG18L + ARYG12L + ARYG09L + ARYG09L is not available. All types other than this combination can be connected.

4 Rooms Multi heating

AOYG30LAT4	Combination of Indoor Unit		HEATING OPERATION							Seasonal Data			
			Heating Capacity				Input Power (min-max)	EER	Pdesign	Energy			
			Room 1	Room 2	Room 3	Room 4				Total Capacity (min-max)	SEER	efficiency class	
		kW	kW	kW	kW	kW	kW	kW	kW				
7	7	14	-	2.42	2.42	4.15	-	9.00 (1.8-10.1)	2.66 (0.58-3.53)	3.38	5.8	3.8	A
7	7	18	-	2.27	2.27	4.86	-	9.40 (3.3-11.2)	2.46 (0.87-3.52)	3.82	5.8	3.8	A
7	7	24	-	2.03	2.03	5.44	-	9.50 (3.3-11.5)	2.47 (0.87-3.52)	3.85	5.8	3.8	A
7	9	12	-	2.49	2.94	3.56	-	9.00 (1.8-10.0)	2.69 (0.58-3.51)	3.35	5.8	3.8	A
7	9	14	-	2.33	2.75	4.00	-	9.10 (3.3-10.2)	2.64 (0.87-3.50)	3.45	5.8	3.8	A
7	9	18	-	2.17	2.56	4.66	-	9.40 (3.3-11.3)	2.45 (0.87-3.50)	3.84	5.8	3.8	A
7	9	24	-	1.98	2.33	5.29	-	9.60 (3.3-11.5)	2.46 (0.87-3.51)	3.90	5.8	3.8	A
7	12	12	-	2.33	3.33	3.33	-	9.00 (1.8-10.1)	2.66 (0.58-3.48)	3.38	5.8	3.8	A
7	12	14	-	2.22	3.17	3.80	-	9.20 (3.3-10.3)	2.62 (0.87-3.48)	3.51	5.8	3.8	A
7	12	18	-	2.08	2.97	4.45	-	9.50 (3.3-11.4)	2.44 (0.87-3.47)	3.89	5.8	3.8	A
7	12	24	-	1.88	2.69	5.03	-	9.60 (3.3-11.7)	2.45 (0.87-3.56)	3.92	5.8	3.8	A
7	14	14	-										

8 Rooms Multi cooling

Table for 8 Rooms Multi cooling with columns for AOYG45LBT8, Combination of Indoor Unit, Cooling Capacity (Rooms 1-8, Total), and Input power.

Note: *Cooling capacity is based on 27°CDB/19°CWB (indoor temperature), 35°CDB (outdoor temperature)
*Pipe Length: 5 m (Outdoor unit to Branch box), 3 m (Branch box to Indoor unit)
*Height difference: 0 m (Outdoor unit to Indoor unit)
*The values in this table should be used only as a guide. These values are calculated at standard conditions.
To fix your selection of models, select them according to *Model Selection* in the D&T manual.

8 Rooms Multi heating

Table for 8 Rooms Multi heating with columns for AOYG45LBT8, Combination of Indoor Unit, Heating Capacity (Rooms 1-8, Total), and Input power.

Note: *Heating capacity is based on 20°CDB (indoor temperature), 7°CDB/6°CWB (outdoor temperature)
*Pipe Length: 5 m (Outdoor unit to Branch box), 3 m (Branch box to Indoor unit)
*Height difference: 0 m (Outdoor unit to Indoor unit)
*The values in this table should be used only as a guide. These values are calculated at standard conditions.
To fix your selection of models, select them according to *Model Selection* in the D&T manual.
*1: LMC type is not available for this combination.

OPTIONAL PARTS FOR SPLIT & MULTI SPLIT

Type	Wall Mounted										Duct						Cassette				Floor	Ceiling/Floor	Ceiling				
	Compact					Large					Slim	Medium static	High static	Compact		Large											
	ASYG 09/12/LCA	ASYG 07/09/12/14/LUCA	ASYG 07/09/12/14/LMCA	ASYG 07/09/12/LCC	ASYG 18/30/LFCA/24/LFCC	ASYG 30/36/LMTA	ARYG 07/09/LLA/12/14/LLTB	ARYG 18/30/LLA/24/LLLT	ARYG 22/24/36/45/LMLA	ARYG 24/30/45/54/LHTBP				ARYG 45/54/LHTA	ARYG 60/LHTA	ARYC 72/90/LHTA	AUYG 07/09/LVA/12/14/LVLA	AUYG 12/14/LVLA	AUYG 22/24/LVA	AUYG 18/24/30/36/45/54/LRLA				AUYG 36/45/54/LRLB	AUYG 18/24/30/36/45/54/LRLB		
Controllers												● UTY-RNRZ1 + UTY-TWRX						● UTY-RNRZ1									
												● UTY-RLRY + UTY-TWRX						● UTY-RLRY									
		● UTY-RVNYM					● UTY-RVNYM + UTY-XWNX					● UTY-RVNYM						● UTY-RVNYM		● UTY-RVNYM		● UTY-RVNYM					
		● UTY-RNNYM					● UTY-RNNYM + UTY-XWNX					● UTY-RNNYM						● UTY-RNNYM		● UTY-RNNYM		● UTY-RNNYM					
Simple Remote Controller	● UTY-RSNYM										● UTY-RSNYM + UTY-XWNX						● UTY-RSNYM				● UTY-RSNYM	● UTY-RSNYM	● UTY-RSNYM				
Central Remote Controller	● UTY-DMMYM										● UTY-DMMYM						● UTY-DMMYM				● UTY-DMMYM	● UTY-DMMYM					
IR Receiver Kit with Wireless Remote Controller											● UTY-LRHYM						● UTY-LRHYM										
Human Sensor Kit																	● UTY-LBTHM										
Remote Sensor Unit											● UTY-XSZX																
Auto Louver Grille Kit											● UTD-GXTA-W		● UTD-GXTB-W														
Long Life Filter											● UTD-LF25NA		● UTD-LFNA/UTD-LFNB/UTD-LFNC								● UTD-LF60KA						
Flange											● UTD-RF204/UTD-SFD45T										● UTD-RF204						
Drain Pump Unit											● UTY-PX1NBA										● UTY-PX1NBA						● UTR-DPB24T
Wide Panel																	● UTG-AKXA-W										
Panel Spacer	Panel spacer																● UTG-BKXA-W										
Fresh Air Intake Kit	For Compact Cassette For Cassette																● UTY-VXAA				● UTY-VXRA						
Air Outlet Shutter Plate	For Compact Cassette For Cassette																● UTR-YDZB				● UTR-YDZK						
Insulation for High Humidity	For Compact Cassette type / Cassette type																● UTY-KXGC				● UTY-KXRA						
Half Concealed Kit	This kit is used to half conceal floor type indoor unit into the wall.																				● UTR-STA						
Remote controller holder											● UTY-RXLA																

Optional parts list (Interface /Communication Kit/External Connect Kit)

Type	Wall Mounted										Duct						Cassette				Floor	Ceiling/Floor	Ceiling	Outdoor unit			
	Compact					Large					Slim	Medium static	High static	Compact		Large		Single-phase	3-phase								
	ASYG 09/12/LCA	ASYG 07/09/12/14/LUCA	ASYG 07/09/12/14/LMCA	ASYG 18/30/LFCA/24/LFCC	ASYG 30/36/LMTA	ARYG 07/09/LLA/12/14/LLTB	ARYG 18/30/LLA/24/LLLT	ARYG 22/24/36/45/LMLA	ARYG 24/30/45/54/LHTBP	ARYG 45/54/LHTA				ARYG 60/LHTA	ARYC 72/90/LHTA	AUYG 07/09/LVA/12/14/LVLA	AUYG 12/14/LVLA			AUYG 22/24/LVA				AUYG 18/24/30/36/45/54/LRLA	AUYG 36/45/54/LRLB	AUYG 18/24/30/36/45/54/LRLB	ADYG 09/12/LVCA
Interface		● UTY-TFNXZ1										● UTY-TFNXZ1						● UTY-TFNXZ1				● UTY-TFNXZ1	● UTY-TFNXZ1	● UTY-TFNXZ1			
		● FJ-RC-WIFI-1										● FJ-RC-WIFI-1						● FJ-RC-WIFI-1				● FJ-RC-WIFI-1	● FJ-RC-WIFI-1	● FJ-RC-WIFI-1			
		● FJ-RC-KNX-1i										● FJ-RC-KNX-1i						● FJ-RC-KNX-1i				● FJ-RC-KNX-1i	● FJ-RC-KNX-1i	● FJ-RC-KNX-1i			
		● UTY-VMSX										● UTY-VMSX						● UTY-VMSX				● UTY-VMSX	● UTY-VMSX	● UTY-VMSX			
MODBUS Interface	● FJ-RC-MBS-1										● FJ-RC-MBS-1						● FJ-RC-MBS-1				● FJ-RC-MBS-1	● FJ-RC-MBS-1	● FJ-RC-MBS-1				
Communication Kit		● UTY-TWBXF										● UTY-XCBXZ2						● UTY-TWRX									
												● UTY-XWNX															
External input and output PCB											● UTY-XCSXZ1						● UTY-XCSX										
External input and output PCB Box											● UTY-GXXB						● UTY-GXRA										
External input and output PCB Bracket											● UTY-GXNA						● UTY-KWZXZG										
External Connect Kit		For Indoor Unit *Duct type is excluded.										● UTY-XWZX						● UTY-XWZX				● UTY-XWZX	● UTY-XWZX	● UTY-XWZX			
		For Indoor Unit *Duct type is excluded.										● UTY-XWZXZ5															
		For Outdoor Unit																				● UTY-XWZXZ3					
		For Outdoor Unit																				● UTY-XWZXZ4		● UTY-XWZXZ4			
External Control Set		For Indoor Unit (Duct type only) Use to connect with various peripheral devices and air conditioner PCB board.										● UTD-ECSSA						● UTD-ECSSA				● UTD-ECSSA				● UTD-ECSSA	

NEW

Wired Remote Controller (Touch Panel)

Function list

External Control		Input					Output					
		Start/Stop	Peak cut	Low noise	Priority	Emergency stop	Operation status	Error status	Fresh Air	Auxiliary Heater	Base heater	Preparation
Wall Mounted												
Compact	ASYG09/12LTC (A*)	●2					●2	●2				
	ASYG07/09/12/14LUCA (A*)	●2					●2	●2				
	ASYG07/09/12/14LMCA (B*)	●2					●2	●2				
Large	ASYG18/30LFC	●1					●1					
	ASYG24LFC	●1					●1					
	ASYG30/36LMTA (C*)	●1					●1	●3				
Duct												
Slim	ARYG07/09LLTA	●4					●4		●4	●4		
	ARYG12/14/18LLTB	●4					●4		●4	●4		
	ARYG24/36/45LMLA	●4					●4		●4	●4		
Medium Static	ARYG30/36LMLA	●4					●4		●4	●4		
	ARYG30/36LMLA	●4					●4		●4	●4		
	ARYG12/14/18/24/30/36/45/54LHTBP (D*)	●0*					●3	●3	●3	●3		
High Static	ARYG45/54LHTA	●4					●4		●4	●4		
	ARYG60LHTA	●4					●4		●4	●4		
	ARYC72/90LHTA	●4					●4		●4	●4		
Cassette												
Compact	AUYG07/09LVA	●4					●4		●0*			
	AUYG12/14/18LVLB	●4					●4		●0*			
	AUYG24LVA	●4					●4		●0*			
Large	AUYG30/36LRL	●4					●4		●0*			
	AUYG36/45/54LRLA	●4					●4		●0*			
	AUXG18/24/30/36/45/54LRLB (E*)	●0*					●3	●3	●3	●3		
Floor												
	AGYG09/12/14LVCA	●1					●1					
Floor Ceiling												
	ABYG14LVT	●1					●1					
	ABYG18LVTB	●1					●1					
	ABYG24LVT	●1					●1					
Ceiling												
	ABYG30/36LRTE	●1					●1		●4			
	ABYG36/45/54LRTA	●1					●1		●4			
Single phase												
Single Split	AOYG45/54LETL		●6	●6			●6	●6			●7	
8 Rooms Multi	AOYG45LBT8		●6	●6	●6		●6	●6				
Simultaneous Multi	AOYG36/45LBTB		●6	●6			●6	●6				
3Phase												
Single Split	AOYG36/45/54/60LATT		●5	●5			●5	●5			●7	
	AOYA72/90LALT		●5	●5			●5	●5				
Simultaneous Multi	AOYG36/45/54LATT		●5	●5			●5	●5				

A* : UTY-TWBXF Communication Kit required
 B* : UTY-XCBXZ2 Communication Kit required
 C* : UTY-XCSXZ1 External input and output PCB/UTZ-GXXB External input and output PCB Box required
 D* : UTY-XCSX External input and output PCB/UTZ-GXNA External input and output PCB Bracket required
 E* : UTY-XCSX External input and output PCB/UTZ-GXRA External input and output PCB Box required
 0* : Optional part is not required

Communication Kit



UTY-TWBXF/UTY-XCBXZ2

External input and output PCB

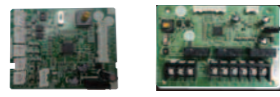

UTY-XCSXZ1 UTY-XCSX

External input and output PCB Box

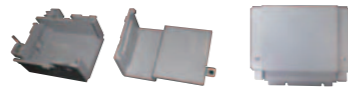

UTZ-GXXB UTY-GXRA

External input and output PCB Bracket



UTZ-GXNA

External Connect Kit For Indoor Unit

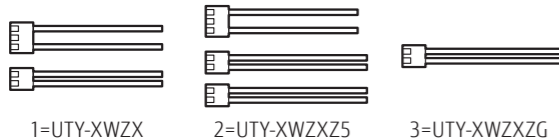

1=UTY-XWZX 2=UTY-XWZXZ5 3=UTY-XWZXZG

External Control Set For Indoor Unit

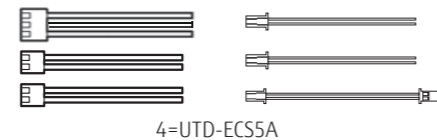

4=UTD-ECS5A

External Connect Kit For Outdoor unit

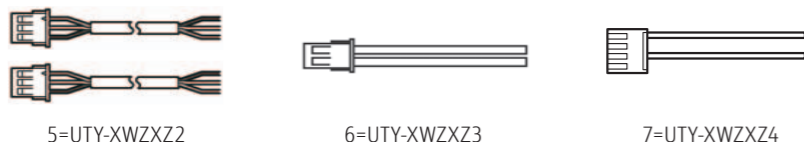

5=UTY-XWZXZ2 6=UTY-XWZXZ3 7=UTY-XWZXZ4

UTY-RNRYZ1



Max. Controllable
16 indoor units

Features

Easy operation by high-definition large STN-LCD touch panel screen

- Easy finger touch operation with LCD panel
- Built-in weekly/Daily timer(ON/OFF,Temp.,Mode)
- Backlight enables easy operation in a darkened room
- Room temperature display
- Control up to 16 indoor units
- Corresponds to 12 different languages (English, Chinese, French, German, Spanish, Russian, Polish, Italian, Greek, Portuguese, Turkish and Dutch)
- 2-wire type

High performance and compact size

In addition to the individual control, weekly timer, and various energy saving controls can be realized using one remote controller only.



Accurate and comfortable control

Indoor temperature can be detected accurately by the inclusion of a thermo sensor in the body of the wired controller.



Various energy saving control

Auto OFF timer

- The indoor unit automatically is turned off when it reaches to the preset operating time frame.
- The time frame of the "Auto off timer" can be flexibly scheduled.
- Can be set off time 30 to 240 minutes

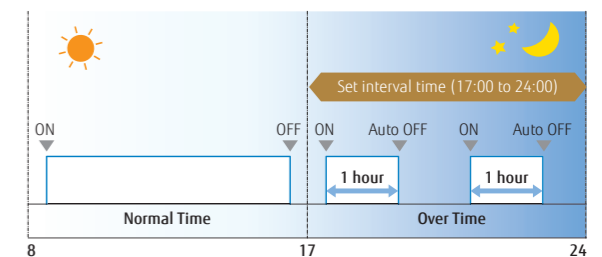

Ex.) At interval time hour (17:00 to 24:00) to prevent forgetting to turn off
 Set off time : 1 hour

2 schedules Weekly Timer

Set Temperature Auto Return

Set Temperature Upper and Lower Limit Setting

Specifications

Model name	UTY-RNRYZ1
Power Source	DC 12 V
Dimensions (H × W × D) (mm)	120 × 120 × 20.4
Weight (g)	220

DC12 V is supplied by the indoor unit.

Wired Remote Controller

UTY-RVNYM

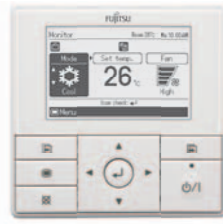

Features

Hi-grade individual control using various functions.

- 3.7-inch LCD backlight screen.
- Supporting various Energy Saving functions with simple operation.
- Multiple Language Support. (English, German, French, Spanish, Russian, Portuguese, Italian, Greek, and Turkish)

Max. Controllable
16 indoor units

High visibility and Easy operation

- Icon display of effectual functions.
- Main functions in large icons: "Mode", "Set Temp", and "Fan".
- Easy to operate by Control guide display.
- Simple operation with easy 4-way navigation pad.

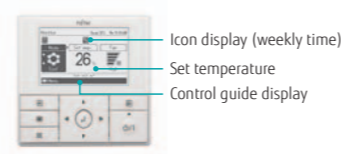

High performance and compact size

- In addition to the individual control, various energy saving controls can be realized using only one remote controller.



Various energy saving control

Weekly Timer function

- Can be set up to 8 times per day (On/Off, mode, Temp)
- 2 pattern settings (i.e. Summer/Winter setting) are available.



Auto OFF Timer

Set Temperature Auto Return

Set Temperature Upper and Lower Limit Setting

Specifications

Model name	UTY-RVNYM
Power Source	DC 12 V
Dimensions (H × W × D) (mm)	120 × 120 × 21.3
Weight (g)	220

DC12 V is supplied by the indoor unit.

NEW

Wired Remote Controller

UTY-RLRY



Features

- Various timer setup (ON / OFF / WEEKLY) are possible.
- The room temperature can be controlled by detecting the temperature accurately with Built-in thermo sensor.
- When a failure occurs, the error code is displayed.
- Error history. (Last 16 error codes can be accessed.)
- 2-wire type

Max. Controllable
16 indoor units

High visibility and easy operation

- "Mode", "Set Temp", and "Fan" are displayed at large size on the top screen.
- Each function to be set is indicated by an icon.
- Control guide is displayed and operation is simple and straightforward.

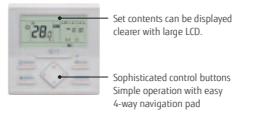

High performance and compact size

- In addition to the individual control, weekly timer, and various energy saving controls can be realized using only one remote controller.



Various energy saving control

Auto-off timer

- The indoor unit automatically turns off after a set time has passed.

Weekly timer function

Set temperature auto return

Set temperature upper and lower limit setting

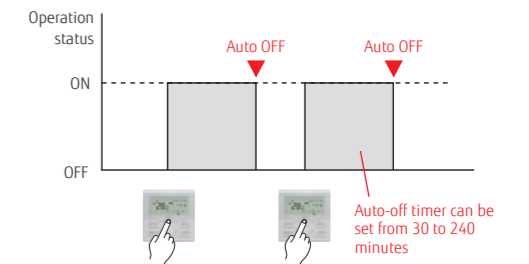

Specifications

Model name	UTY-RLRY
Power Source	DC 12 V
Dimensions (H × W × D) (mm)	120 × 120 × 17
Weight (g)	170

DC12 V is supplied by the indoor unit.

Wireless LAN Interface

UTY-TFNXZ1



Features

- It is the most advanced solution to remotely manage an Air Conditioning system using all sort of mobile devices such as Smartphones, and tablets.
- No separate external power supply required
- Can be used for single indoor units and multi system indoor units

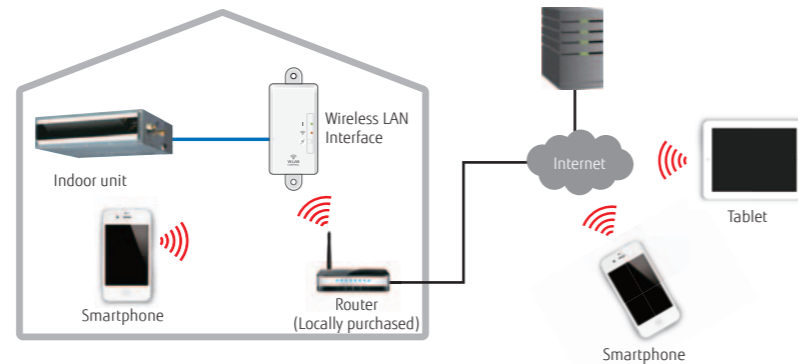

Basic control

- Turning the units on and off
- Mode control (Heat, Cool, Dry, Auto, Fan)
- Fan speed setting
- Louver position (Airflow direction setting)
- Room temperature setting
- Timer operation setting (Weekly timer)
- Economy mode setting

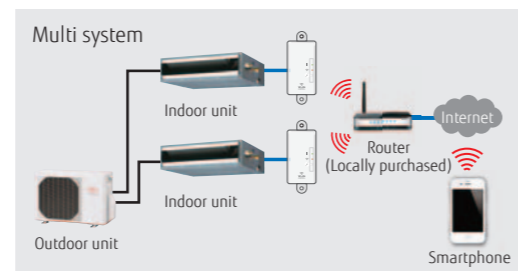

Multiple air conditioning management

- Multiple air conditioning management at difference locations.

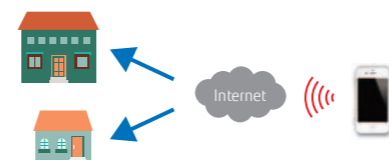

Error display & E-mail notification

- Alerts e-mail notification
- Air conditioning malfunction display
- It enables rapid service response when error occurs.

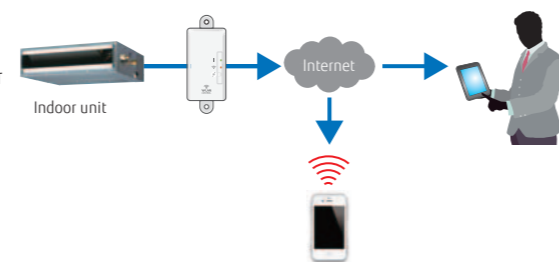

Specifications

Model name	UTY-TFNXZ1
Dimensions (H x W x D) (mm)	71x38x15
Weight (g)	85

Wireless LAN Interface

FJ-RC-WIFI-1



Features



- It is the most advanced solution to remotely manage an Air Conditioning system using all sort of mobile devices such as Smartphones, Tablets and PC
- No separate external power supply required
- Can be used for single indoor units and group controlled (up to 16) indoor units

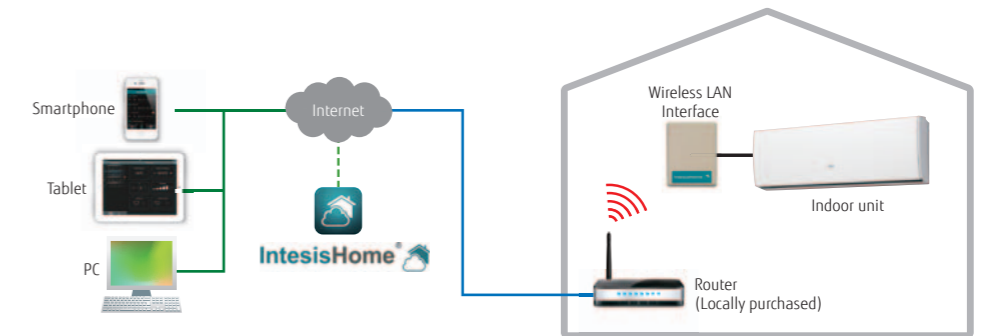

Basic control

- Turning the units on and off
- Mode control (Heat, Cool, Dry, Auto, Fan)
- Fan speed setting
- Louver position (Airflow direction setting)
- Room temperature display
- Set temperature control
- Multi Language
- One Scene and Timer

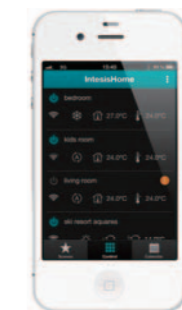

Advanced control (Optional functions)

- Climate working modes (ECO, Comfort, Powerful) (future release)
- Schedulable functionalities (ON/OFF, Modes, Set point temperature, Fan Speed, Louver position)
- Set temperature limitation (future release)
- Multiple Scenes & Timers and Calendar function

Notifications and history

- Alerts e-mail notification (future release)
- Air conditioning malfunction alerts
- Connectivity monitoring and alerts
- History (future release)

Specifications

Model name	FJ-RC-WIFI-1
Dimensions (H x W x D) (mm)	70x108x28
Weight (g)	80

UTY-VMSX



Features

The MODBUS Convertor allows a complete integration of air conditioners into MODBUS Networks.

- Simple installation due to small and compact size.
- No separate external power supply required.
- The MODBUS Convertor must be connected one by one in the indoor unit.
- The MODBUS Controller permits central monitoring and control of air conditioners from BMS/Central/Home Controller.

Max. Connectable

1 Single indoor unit

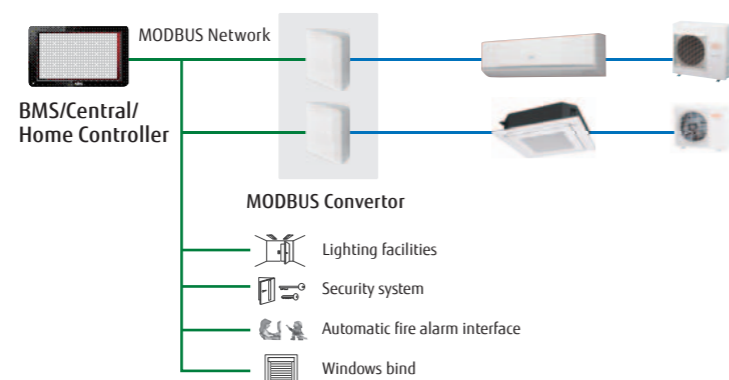

Basic control

- Turning the units on and off
- Mode control (Heat, Cool, Dry, Auto, Fan)
- Fan speed setting
- Louver position (Airflow direction setting)
- Room temperature setting and display
- Economy mode setting
- Error status

Easy Installation

Flexible installation locations with neat wirings are feasible since no power supply cable is used in the convertor.

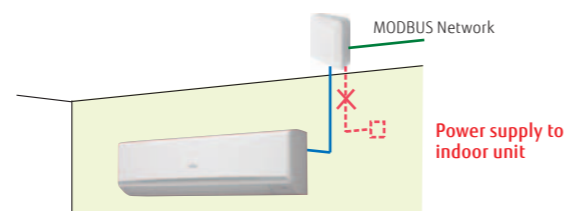

Specifications

Model name		UTY-VMSX	
Power supply		AC220/240V 50/60Hz AC208/230V 60Hz	
Input Power		W	Max. 1.2
Temperature	Operating / Packaged	°C (°F)	0~46(32~114) / -10~60(14~140)
Humidity	Operating / Packaged	%	0~95 / 0~95
Dimensions (H×W×D)(in.)		mm (in.)	43 × 117 × 140
Weight(oz)		g (oz)	200(7)
Maximum Connectable indoor unit number per 1 MODBUS Convertor			1

FJ-RC-MBS-1



Features

The MODBUS Interface allows a complete integration of air conditioners into MODBUS Networks.

- Simple installation due to small and compact size.
- No separate external power supply required.
- The MODBUS Interface permits central monitoring and control of air conditioners from BMS.

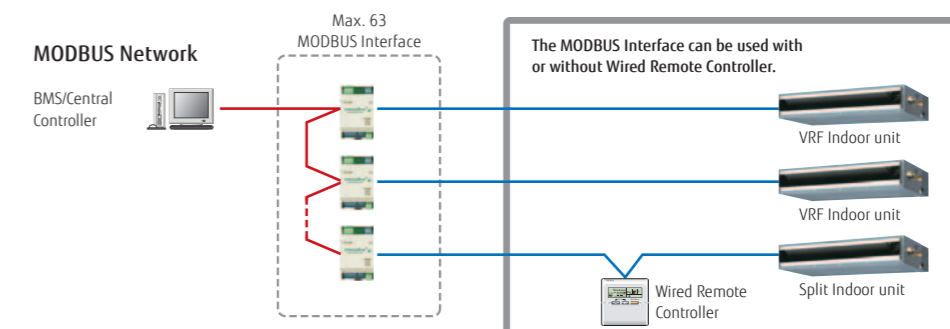

FJ-RC-KNX-1i



Features

The KNX Interface allows a complete integration of air conditioners with KNX Network systems.

- Simple installation due to small and compact size.
- No separate external power supply required (just KNX bus power).
- Can be used for single indoor units and group controlled (up to 16) indoor units.

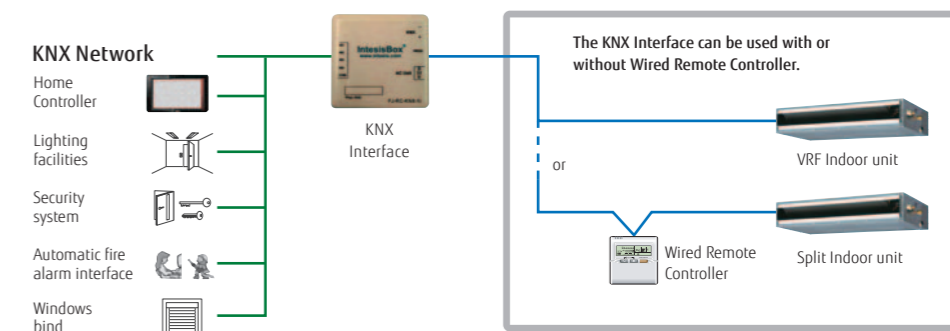

Specifications

Model name	FJ-RC-MBS-1	FJ-RC-KNX-1i
Dimensions (H × W × D) (mm)	93×53×58	70×70×28
Weight (g)	85	70

Auto Louver Grille Kit

UTD-GXTA-W / UTD-GXTB-W / UTD-GXTC-W

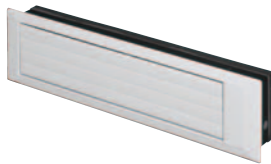

Features

Simple flat Auto Louver will provide comfort airflow and harmonize with luxury interior.



Flexible Control

- **Operation with indoor unit**
Auto Louver can be operated by synchronizing remote controller of indoor unit.
- **UP and Down auto swing**
 - Auto airflow direction and auto swing
 - 4 steps selectable
- **Auto-closing louver**
When operation of indoor unit is stopped, the louver will automatically close.

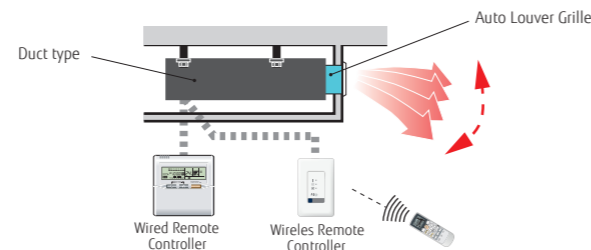

Dimensions

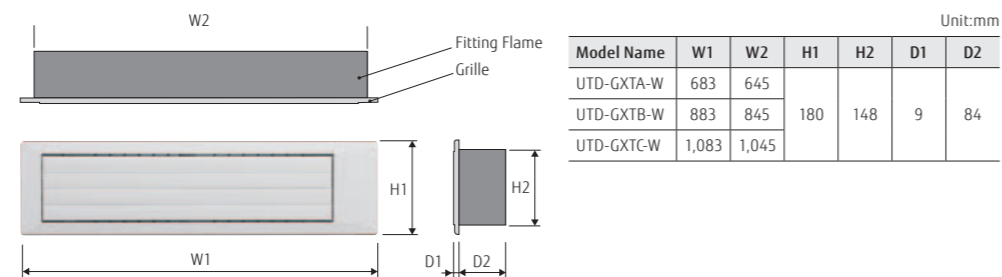

Specifications

Model name	UTD-GXTA-W	UTD-GXTB-W	UTD-GXTC-W	
Applicable Indoor Unit	ARYG07/09LLTA ARYG12/14LLTB ARXD04/07/09/12/14GALH (For VRF) ARXK07/09/12/14GCLH (For VRF)	ARYG18LLTB ARXD18GALH (For VRF) ARXK18GCLH (For VRF)	ARXD24GALH (For VRF) ARXK24GCLH (For VRF)	
Power Supply	Connecting with Control box of indoor unit			
Fixing of Auto Louver Grille	Screw fixing to Flange or Square Duct			
Extension Square Duct Limit	1.0m (Max. duct length between indoor unit and Grille)			
Net Dimension (H × W × D)	mm (inch) 180×683×(84+9) [7-3/32×26-7/8×(3-5/16+11/32)]	180×883×(84+9) [7-3/32×34-3/4×(3-5/16+11/32)]	180×1083×(84+9) [7-3/32×42-5/8×(3-5/16+11/32)]	
Weight	Net	2.0 (4.4)	2.5 (5.6)	3.0 (6.7)
	Gross	3.0 (6.7)	3.5 (7.8)	4.0 (8.9)
Color	White			
Louver Motor	Stepping Motor			
Accessories	Fitting Flame, etc.			
Operation range	Cooling	°C (°F)	18 to 32 (64 to 90)	
		% RH	80% or less	
	Heating	°C (°F)	16 to 30 (60 to 88)	

REFRIGERANT PIPING PARTS

Connection Units

Separation Tube
UTP-SX236A / UTP-SX254A
For 3-phase simultaneous multi



UTP-SX354A
For 3-phase simultaneous multi



UTP-SX248A
For 8 Rooms Multi

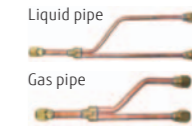

Branch Box
UTP-PY03A / UTP-PY02A
For 8 Rooms Multi



OPTIONAL PARTS

Controllers

For Individual & Centralized Control

Wired Remote Controller
UTY-RNRYZ1 **NEW**



Wired Remote Controller
UTY-RLRY **NEW**



Wired Remote Controller
UTY-RVNYM



Wired Remote Controller
UTY-RNNYM



Simple Remote Controller
UTY-RSNYM



Central Remote Controller
UTY-DMMYM
For 8 Rooms Multi









Communication devices

Interface

<p>Wireless LAN Interface UTY-TFNXZ1 NEW</p> 	<p>Wireless LAN Interface FJ-RC-WIFI-1</p> 	<p>MODBUS® Convertor UTY-VMSX NEW</p> 	<p>MODBUS® Interface FJ-RC-MBS-1</p> 
--	---	--	---





<p>KNX® Interface FJ-RC-KNX-1i</p> 



Communication Kit/External input and output PCB/Box/Bracket

<p>Communication Kit UTY-TWBXF/UTY-XCBXZ2/UTY-TWRX For Compact Wall Mounted</p> 	<p>External input and output PCB UTY-XCSXZ1 NEW</p>  <p>UTY-XCSX NEW</p> 	<p>External input and output PCB Box UTZ-GXXB NEW</p>  <p>UTZ-GXRA NEW</p> 	<p>External input and output PCB Bracket UTZ-GXNA NEW</p> 
--	--	---	---

Others

For Duct type

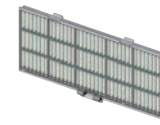
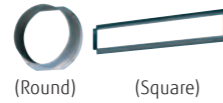
<p>IR Receiver Kit UTY-LRHYM</p> 	<p>IR Receiver Kit UTY-LBTYM NEW</p> 	<p>Remote Sensor Unit UTY-XSZX</p> <p>New amenity space can be offered by installing the Remote sensor.</p> 	<p>Auto Louver Grille Kit UTD-GXTA-W/UTD-GXTB-W For Slim Duct</p> 
---	--	---	--

<p>Long Life Filter UTD-LF25NA/ UTD-LFNA/UTD-LFNB/ UTD-LFNC/UTDLF60KA</p> 	<p>Flange UTD-RF204 (Round) UTD-SF045T (Square)</p>  <p>(Round) (Square)</p>	<p>Drain Pump Unit UTZ-PX1NBA For Medium Static Pressure Duct</p> 
--	--	---

For Cassette type

<p>IR Receiver Kit UTY-LRHYA2</p> 	<p>IR Receiver Kit UTY-LBTYC NEW</p> 	<p>Human Sensor Kit UTY-SHZXC NEW</p> 	<p>Wide Panel UTG-AKXA-W</p>  <p>Indoor unit 950 Panel 600 (mm)</p>
--	--	---	---

<p>Panel Spacer UTG-BKXA-W</p>  <p>242 mm Panel spacer</p>	<p>Fresh Air Intake Kit UTZ-VXAA For Compact Cassette</p> 	<p>Fresh Air Intake Kit UTZ-VXRA For Cassette</p> 	<p>Air Outlet Shutter Plate UTR-YDZB For Compact Cassette</p> <p>Shuts the air outlet when only using as 3 blow out.</p> 
--	--	--	---

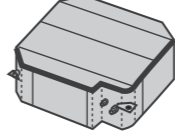
<p>Air Outlet Shutter Plate UTR-YDZK</p> <p>Shuts the air outlet when only using as 3 blow out.</p> 	<p>Insulation for High Humidity UTZ-KXGC/UTZ-KXRA For Compact Cassette type / Cassette type</p> 
--	--

For Ceiling type For Floor type For Wall Mounted type

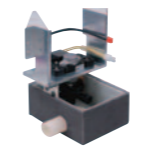
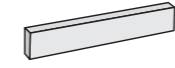
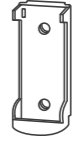
<p>Drain Pump Unit UTR-DPB24T</p> 	<p>Half Concealed Kit UTR-STA</p> <p>This kit is used to half conceal floor type indoor unit into the wall.</p> 	<p>Remote controller holder UTZ-RXLA For ASYG07/09/12LLCC</p> 
--	--	--

VRF



AIRSTAGE™ VRF Systems can be designed to create an air conditioning solution to suit most buildings requirements.

AIRSTAGE™ VRF Systems can be designed to effectively provide an air conditioning solution from a large domestic residence through to a large scale commercial building.



- 130 All Type Lineup
- 132 AIRSTAGE™ Outline
- 134 AIRSTAGE™ series Common Features
- 141 AIRSTAGE™ Outdoor Units
 - AIRSTAGE™ VR-II Heat Recovery Modular Type
 - AIRSTAGE™ V-III Heat Pump Modular Type
 - AIRSTAGE™ V-II Heat Pump Modular Type
 - **NEW** AIRSTAGE™ J-III Heat pump type
 - AIRSTAGE™ J-IIS Heat pump type
- 170 Indoor Unit Lineup
- 176 Controller
- 200 VENTILATION
- 208 Optional Parts for VRF

All Type Lineup

Outdoor units

Capacity (kW)	12.1	14.0	15.1-15.5	22.4	28.0	33.5	40.0	45.0	50.4	55.9	61.5	67.0	73.5	78.5	85.0	90.0	95.0	100.5	107.0	112.0	118.5	123.5	130.0	135.0	140.0	145.0	150.0	
HP	4	5	6	8	10	12	14	16	18	20	22	24	26	28	30	32	34	36	38	40	42	44	46	48	50	52	54	
VR-II series Heat Recovery Page 142 ~	Space saving Set Model																											
	Energy efficiency Set Model																											
V-III series Heat Pump Page 150 ~	Space saving Set Model																											
	Energy efficiency Set Model																											
V-II series Heat Pump Page 156 ~	Space saving Set Model																											
	Energy efficiency Set Model																											
NEW J-III series Heat Pump Page 162 ~	 AJY040LBLAH AJY040LELAH	 AJY045LBLAH AJY045LELAH	 AJY054LBLAH AJY054LELAH																									
J-IIS series Heat Pump Page 166 ~	 AJY040LCLAH	 AJY045LCLAH	 AJY054LCLAH																									

* Production by order
V-III tropical series: Possible to operate up to 52°C outdoor temperature. Heavy anti-corrosion treatment design.
Capacity range 8 HP (AJY072LNLBH) to 54 HP (AJY486LNLBH). 39 models

Indoor units & Ventilations



Indoor units
Capacity range 1.1 kW to 28.0 kW
(J-III & J-IIS can be connected up to 14.0 kW.)

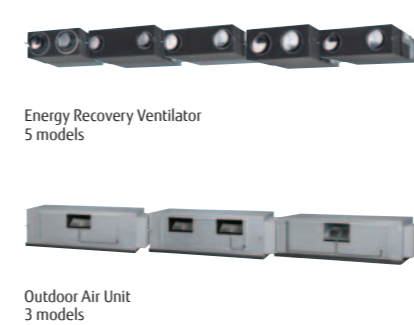

Ventilations
2 type 8 models

Controllers



Various Easy-To-Use Controllers
User's needs are supported by offering a variety of controls, such as individual control, central control, and building management control options.

AIRSTAGE™ SERIES Outline



Systems for Large Offices, Hotels, and Large Composite Facilities

Heat Recovery Modular type for simultaneous heating and cooling operation



AIRSTAGE™ VR-II

- 8 HP - 48 HP 34 Models
- Space saving combination: 8 HP to 48 HP/ 21 models
- Energy efficiency combination: 16 HP to 44 HP/ 13 model

Heat Pump Modular type for heating or cooling operation



AIRSTAGE™ V-III

- 8 HP - 54 HP 39 Models
- Space saving combination: 8 HP to 54 HP/ 24 models
- Energy efficiency combination: 16 HP to 46 HP/ 15 models



AIRSTAGE™ V-II

- 8 HP - 48 HP 33 Models
- Space saving combination: 8 HP to 48 HP/ 21 models
- Energy efficiency combination: 16 HP to 44 HP/ 12 models

Systems for Large Homes to Medium-sized Offices, Shops

Heat Pump type for heating or cooling operation



AIRSTAGE™ J-III

- 4 HP, 5 HP, 6 HP 6 Models
- Single phase, 3 phase



AIRSTAGE™ J-IIS

- 4 HP, 5 HP, 6 HP 3 Models

AIRSTAGE™ series Common Features

- 134 Highly Energy Efficiency
- 135 Energy Saving Function
- 135 More Comfort
- 136 Design Flexibility
- 138 High Reliability
- 139 Easy Installation
- 140 Easy Service & Maintenance

Common Features

Common Features

Energy Saving Function

Economy operation

Economy operation can be set by remote controller. The temperature setting is offset automatically over a certain period of time.

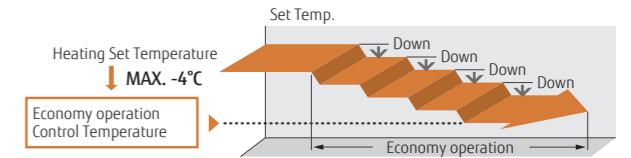

Room temperature set point limitation

The minimum and maximum temperature ranges can be limited, which provide further energy saving while maintaining the comfort of the occupants.

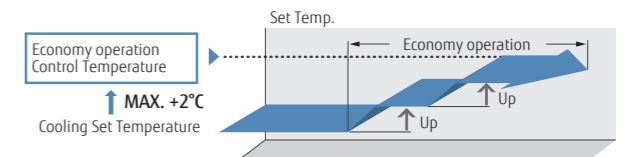

Auto-off timer

- The indoor unit automatically is turned off when it reaches to the preset operating time frame.
- The time frame of the "Auto off timer" can be flexibly scheduled.

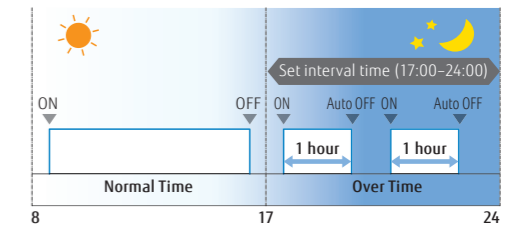

Capacity save operation

Operation capacity can be set in 5 steps for rated capability. The power consumption at peak is cut down and the maximum load is suppressed.

High Energy Efficiency

Efficiency is improved significantly by using DC twin rotary compressor, inverter technology, and large heat exchanger

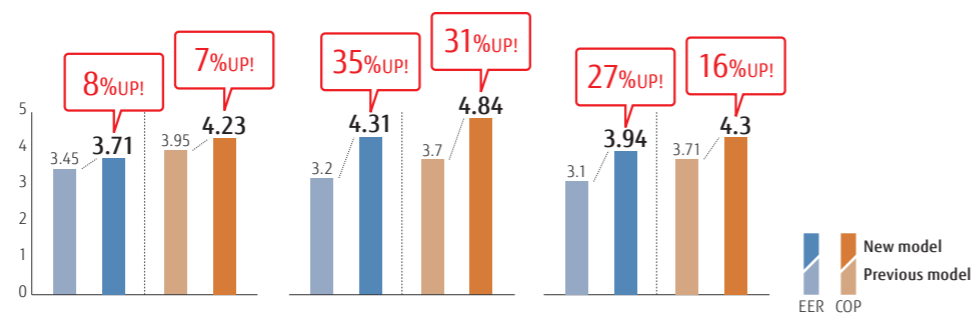

Heat Pump (6HP)



Heat Pump (8HP)



Heat Recovery (10HP)

More Comfort

Precision refrigerant flow control

Precise and smooth refrigerant flow control is achieved by using a DC Inverter control in conjunction with individual indoor unit electronic expansion valve control. This allows high precision comfortable temperature control of $\pm 0.5^{\circ}\text{C}$.

Auto changeover function

At Auto setting, the cooling/heating mode is automatically switched according to the set temperature and room temperature.

Quiet operation

Two low noise modes can be selected automatically by quiet priority setting and capacity priority setting depending on the indoor environment and outside temperature load. This feature can be controlled via outdoor unit external input and/or system controller.

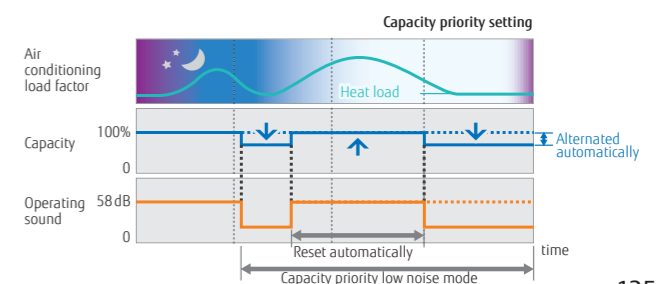
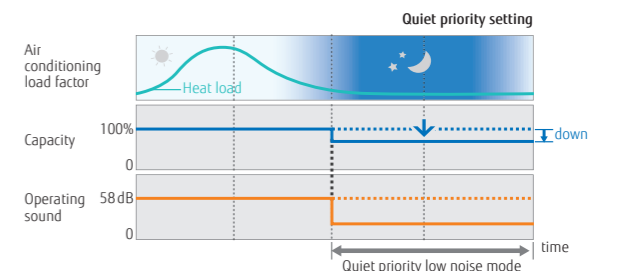

Design Flexibility

Overall piping length Max. 1,000 m

World's top class overall piping length of 1,000 m allows for application in a wide variety of buildings.

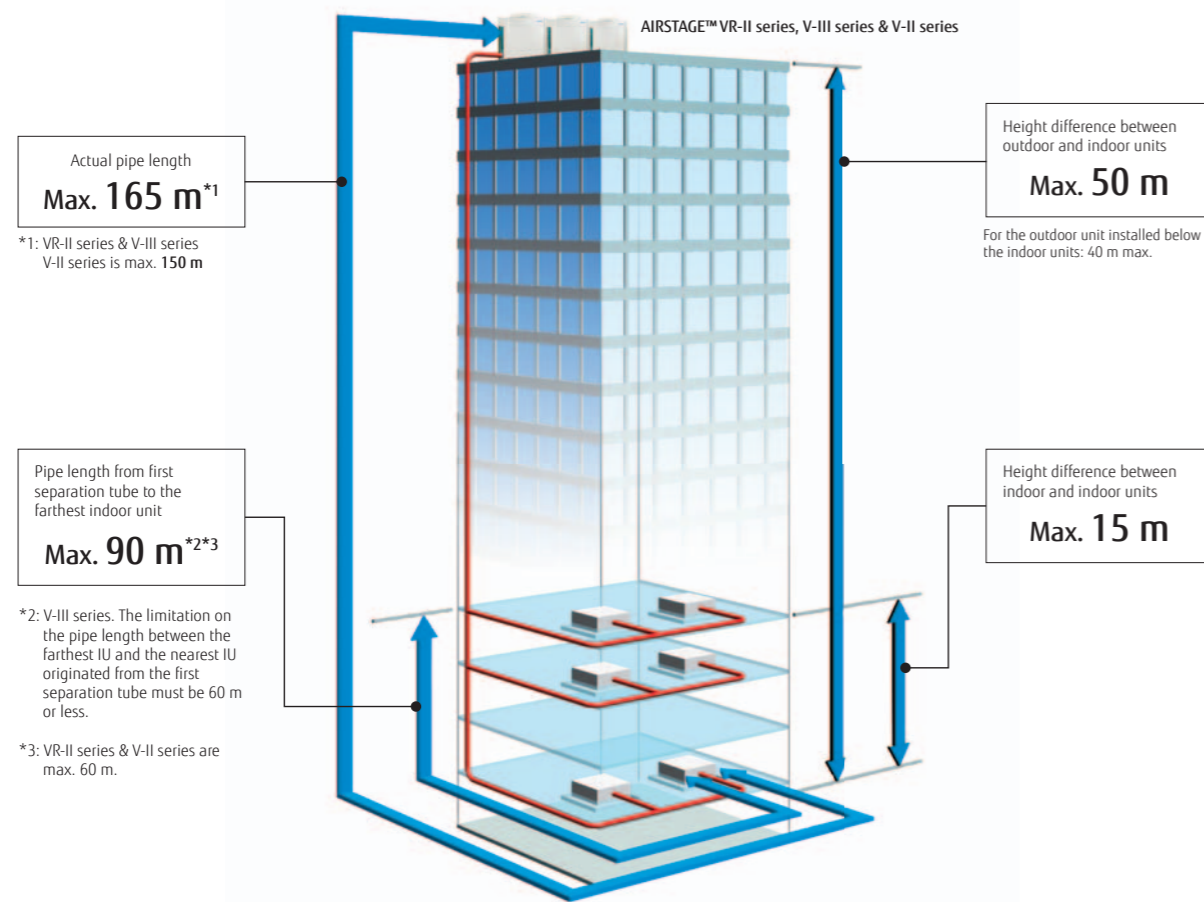

High static pressure

The outdoor unit can have a condenser hood easily connected with a static pressure of 82 Pa*4 standard. This allows outdoor units to be installed within plant rooms in high rise buildings.

Large diameter fan and DC motor has been utilized allowing an external static pressure of 82 Pa*4. This is approximately 2.6 times greater than the previous model.

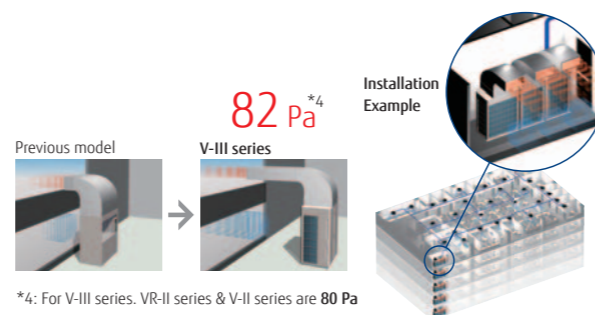

High capacity connection

Series	Connectable indoor unit capacity range	Connectable indoor unit number
AIRSTAGE™ VR-II series Heat Recovery Modular type	50% to 150%*5	up to 64
AIRSTAGE™ V-II series Heat Pump Modular type		up to 48
AIRSTAGE™ V-III series Heat Pump Modular type	50% to 150%*6	up to 64
AIRSTAGE™ J-III series Heat Pump type	50% to 150%*5	up to 13
AIRSTAGE™ J-IIS series Heat Pump type	50%*7 to 130%*5	up to 8

*5: Conditions of maximum connectable indoor unit capacity ratio is as the chart above.

*6: Max. capacities in the combinations including the 18 HP outdoor unit fall below 150%.

*7: Only 4 HP is 46%

Wide operating range

Installation in extreme temperature conditions is possible due to an increase in operational range.

*8: Note: When a multiple outdoor unit connection is used, operating range is from -5°C to 46°C in cooling.

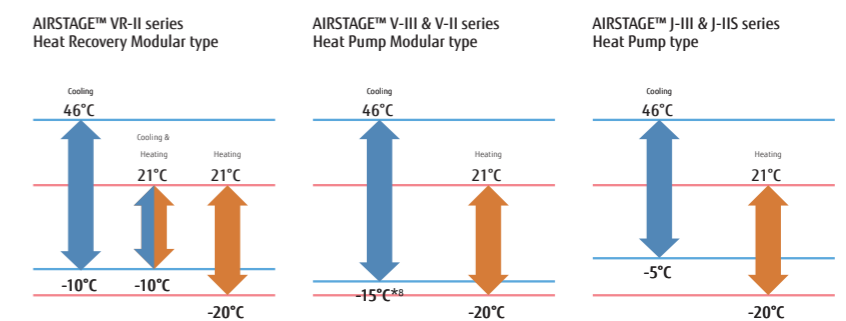

High Reliability

Life-extending operation*1

The compressor starting order is rotated so that the running time is shared.
 Note: Rotational operation is alternated by the start / stop timing of the compressor.

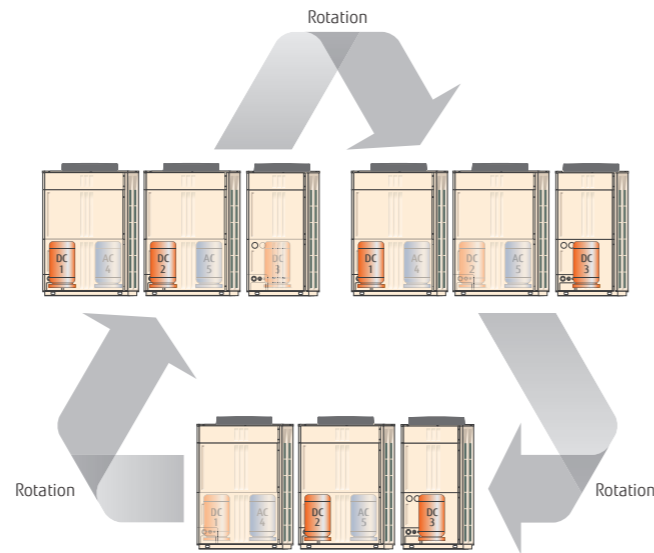

Liquid flow back protection

By adopting a large sized accumulator, not completely vapourised refrigerant stays inside of the accumulator to ensure no liquid refrigerant is being fed into the compressor.

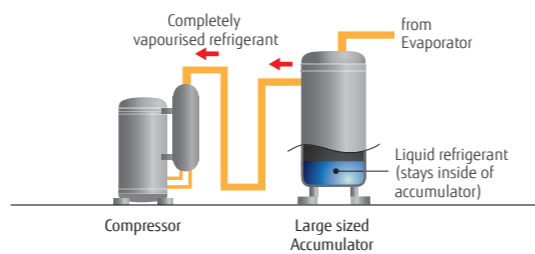

Adoption of blue fin heat exchanger

Corrosion resistant of the heat exchanger has been improved by the introduction of blue fin treatment to the outdoor unit's heat exchanger.

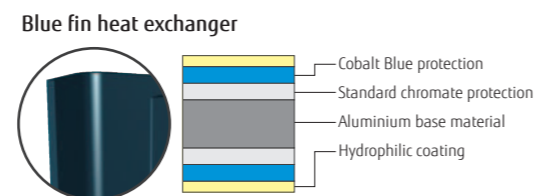

Backup operation*1

If one compressor fails, backup operation will be performed by the remaining compressors.*2

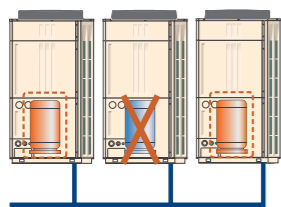

Advanced refrigerant control*1

Innovative compressor control logic has been introduced in order to balance the refrigerant mass flow rate of each outdoor unit by controlling the inverter speed.

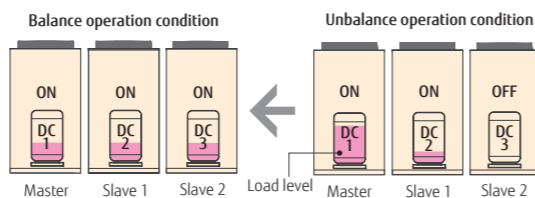

*1: Not available for AIRSTAGE™ J-III and J-IIS series *2: Note: Backup operation may not be possible depending on the trouble state.

Easy Installation

Easily transported

- Easily craned using lifting belt hooks: Design of outdoor unit allows for lifting straps to be used.
- Transporting by forklift: Transport with forklift is possible.
- Can be transported in a small elevator



Easy access

By adopting a L-Shape front panel that can be removed, the work space for installation and service has been significantly expanded by this new design.

For multiple installations, work is performed easily and efficiently even in a narrow space.

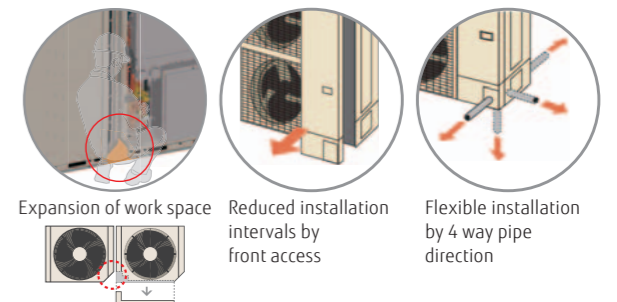

Simple wiring work

Installation of the wiring systems is made easier as the communication wiring can be installed continuously between the indoor, outdoor and RB units.

Note: Serial connection can't use the automatic address setting in a multiple refrigerant system.

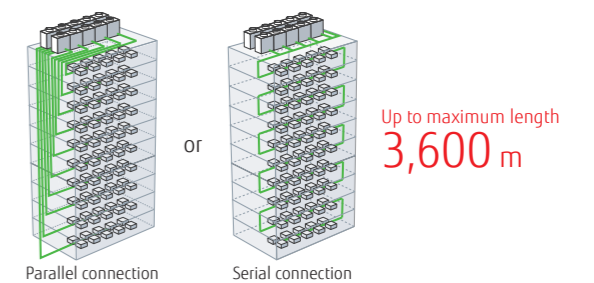

Automatic address setting

The address of the indoor unit, RB unit and signal amplifier through the automatic function setting on the outdoor unit PCB.

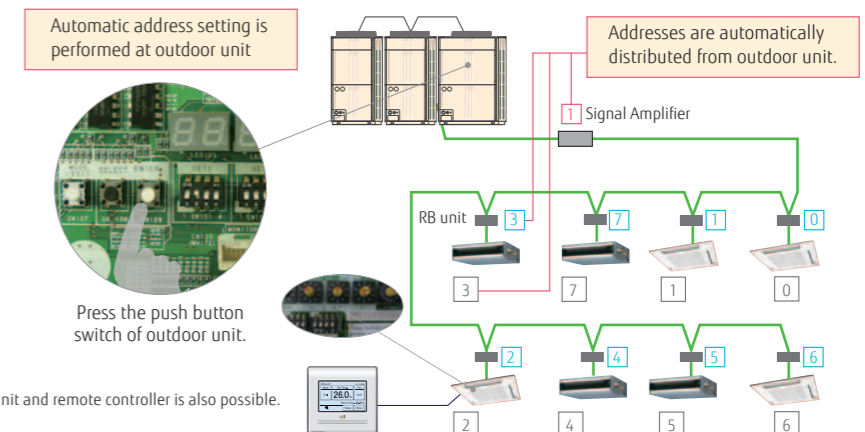

Manual address setting from indoor unit and remote controller is also possible.

Easy Service & Maintenance

Design for easy maintenance

Easy to read 7-segment LED :
Confirm detailed operational and error status without using any specific equipment.

- Operation mode status
- Discharge temperature/Pressure status
- Compressor operation indication
- Address/type/number of outdoor unit

Movable PCB panel:

Easier for maintenance work behind the PCB

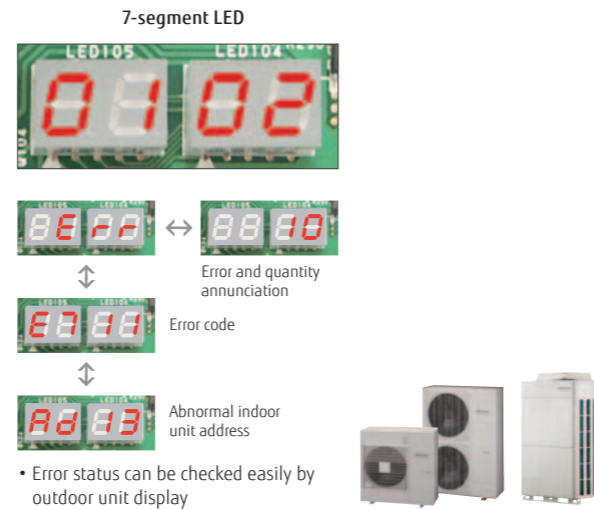

Error status can be checked easily via the indoor unit wired controller
An error code is displayed on a liquid crystal screen.

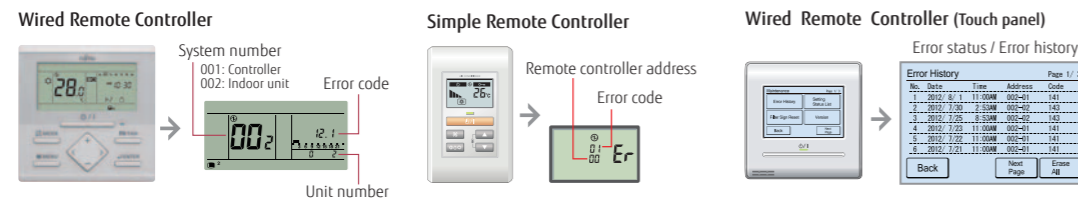

Error diagnosis by Service Tool

Connection to Service Tool

- Detail operation status and recent error history can be checked and analyzed by using the Service Tool.
- Last 5 min. operation memory can be also be recorded.

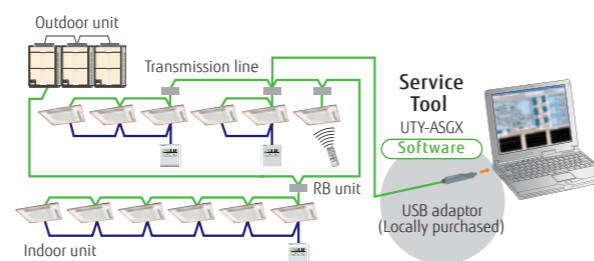

Remote monitoring

The Web Monitoring system allows you to view system operation anytime over the internet, ensuring issue free operation.

The operating VRF network system in the building can be monitored real time over the Internet.

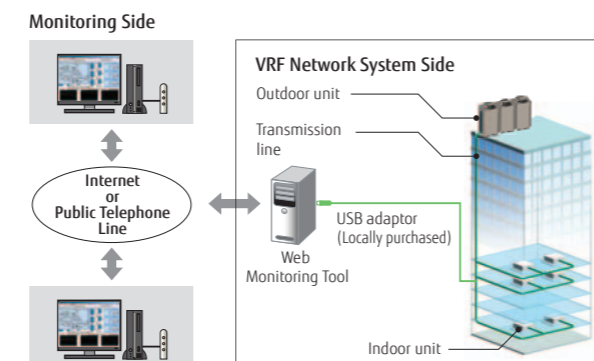

OUTDOOR UNITS

Heat Recovery Modular type

142 **AIRSTAGE VR-II**

Heat Pump Modular type

150 **AIRSTAGE V-III**

156 **AIRSTAGE V-II**

Heat Pump for Small Capacity type

162 **NEW AIRSTAGE J-III**

166 **AIRSTAGE J-IIS**

Heat Recovery Modular Type

AIRSTAGE™ VR-II

Smart and cutting edge design
 Extensive lineup from 8HP to 48HP in 2HP increment
 Connectable indoor unit capacity ratio up to 150%



System Outline

Simultaneous cooling and heating operation using 1 refrigerant system

Cooling and heating can be freely selected for each indoor unit to provide simultaneous cooling and heating in the rooms with large temperature differences, etc.

Annual cooling operation

Use annual cooling operation for the rooms and other spaces that require constant temperature control throughout the year.

Handles changes in the temperature difference

The operation mode can be freely changed when there are large temperature differences during the day, such as between seasons.



Features

High Operating Energy Efficiency

Our Heat recovery systems achieve high operating energy efficiency by drawing heat from the room to be cooled and transferring it as energy for rooms that are to be heated.

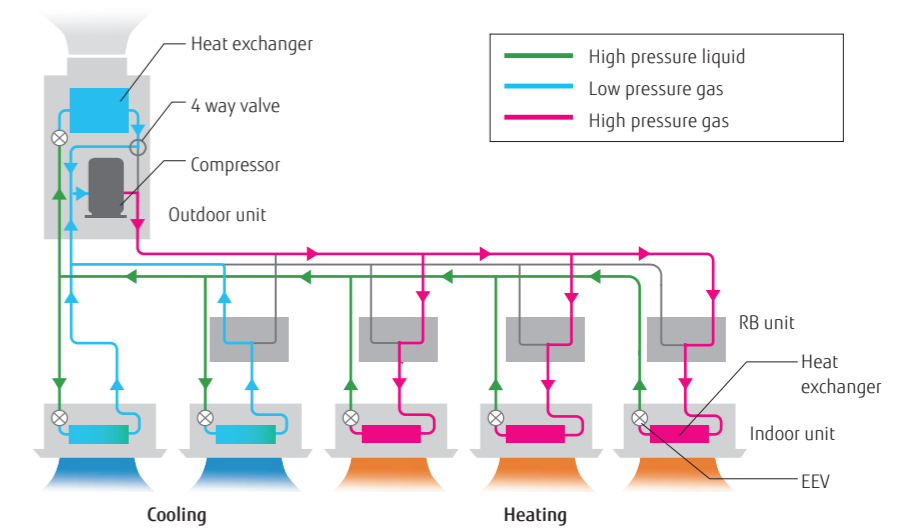

Energy saving technology that boosted operation efficiency

Powerful large propeller fan

By using CFD*1 technology, a newly designed fan achieves high performance and low noise operation.

*1. CFD = Computational Fluid Dynamics

3 phase DC fan motor

Efficiency is substantially improved by high efficient motor with sophisticated driver control. In addition, low noise is realized by DC fan motor.

Sine-wave DC inverter control

High efficiency is realized by adoption of reduced switching loss IPM.

4-face heat exchanger

Heat exchange efficiency is significantly improved by the introduction of a new 4-face heat exchanger that increases effective surface area.

Subcool heat exchanger

High Heat Exchange efficiency is achieved by using an internal projection shape double pipe construction.

Front intake port (corner cut air inhaling structure)

In multiple outdoor unit installations, the unique front intake design improves airflow into the Heat Exchanger.

High efficient and large capacity DC inverter compressor

Large capacity high efficient DC twin rotary compressor with excellent intermediate capability.

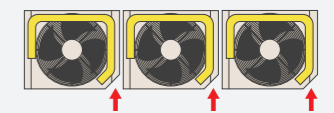

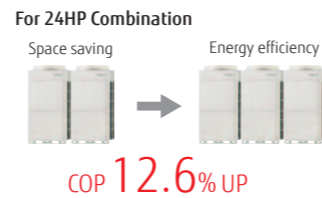
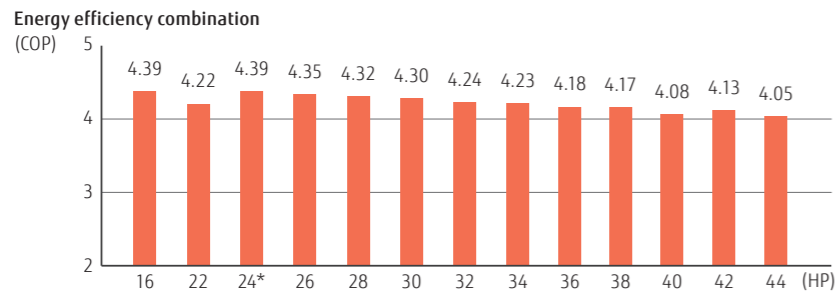
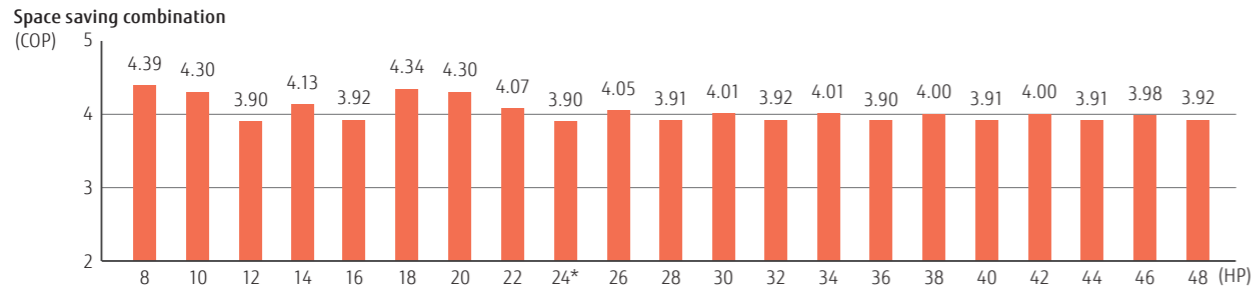

All inverter compressor

Large capacity DC inverter compressor

Large capacity high efficient DC twin rotary compressor with excellent intermediate capability.

High efficient compressor speed control

Comfortable space with small room temperature changes and little energy loss is created by 0.1Hz steps compressor speed control.



Ideal heat exchanger path control

Heat exchanger is split into top and bottom. Heat exchange efficiency is improved by optimum heat exchanger path refrigerant control. Refrigerant is more distributed at the top side heat exchanger with a large intake airflow.

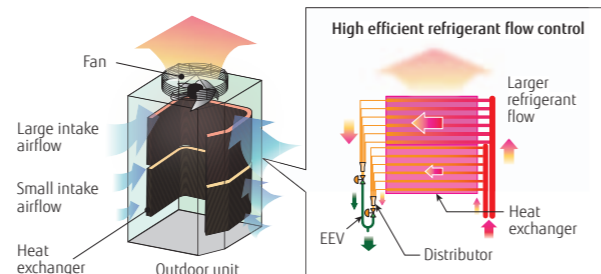

Sophisticated operation control

When multiple outdoor units are connected, sophisticated operation is performed by each compressor. Efficiency is improved by all compressors at part load and distributing refrigerant to all of the heat exchangers rather than to one compressor.

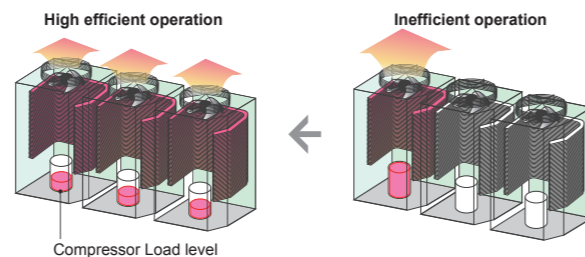

Flexible piping connection

A more flexible refrigerant piping work is possible by the use of various piping and RB Unit connections, for adjustments to the floor layout and building structure.

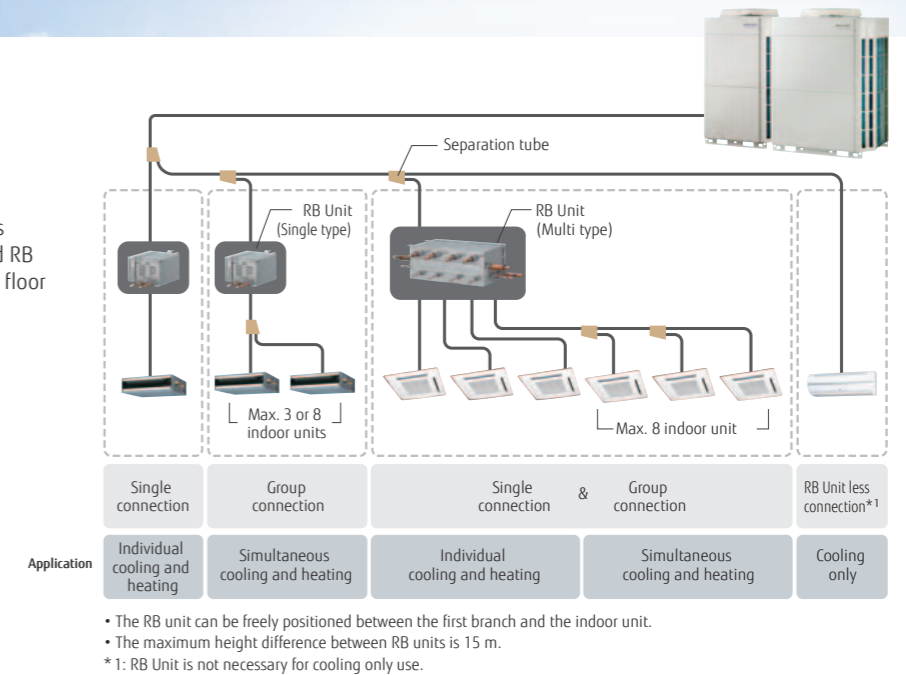

Flexible installation of RB unit

- Small & slim design saves space. Height 198 mm
- A drain pipe is not required
- The control box position can be changed to meet the installation conditions
- Small design saves space
- A drain pipe is not required
- Simple installation series connection design

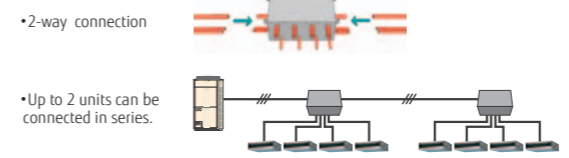
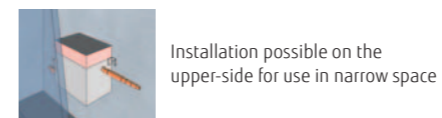
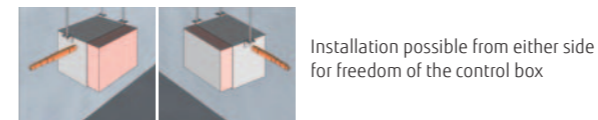

Easy to maintenance in a narrow space

- Maintenance can be performed from the side.
- Electrics box can be temporarily fixed by sliding down.

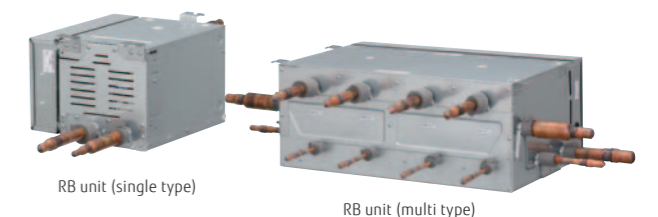
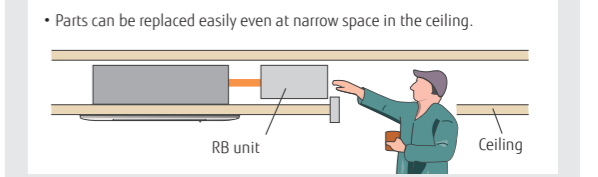

Outdoor units lineup

• Combinations other than the followings are not recommended.

Space saving combination

22.4 kW (8HP)  AJYA72GALH UNIT : AJYA72GALH	28.0 kW (10HP)  AJYA90GALH UNIT : AJYA90GALH	33.5 kW (12HP)  AJY108GALH UNIT : AJY108GALH	40.0 kW (14HP)  AJY126GALH UNIT : AJY126GALH	45.0 kW (16HP)  AJY144GALH UNIT : AJY144GALH
50.4 kW (18HP)  AJY162GALH UNIT : AJYA90/A72GALH	56.0 kW (20HP)  AJY180GALH UNIT : AJYA90/A90GALH	61.5 kW (22HP)  AJY198GALH UNIT : AJY108/A90GALH	67.0 kW (24HP)  AJY216GALH UNIT : AJY108/108GALH	73.0 kW (26HP)  AJY234GALH UNIT : AJY144/A90GALH
78.5 kW (28HP)  AJY252GALH UNIT : AJY144/108GALH	85.0 kW (30HP)  AJY270GALH UNIT : AJY144/126GALH	90.0 kW (32HP)  AJY288GALH UNIT : AJY144/144GALH	95.0 kW (34HP)  AJY306GALH UNIT : AJY108/108/A90GALH	100.5 kW (36HP)  AJY324GALH UNIT : AJY108/108/108GALH
106.5 kW (38HP)  AJY342GALH UNIT : AJY144/108/A90GALH	112.0 kW (40HP)  AJY360GALH UNIT : AJY144/108/108GALH	118.0 kW (42HP)  AJY378GALH UNIT : AJY144/144/A90GALH	123.5 kW (44HP)  AJY396GALH UNIT : AJY144/144/108GALH	130.0 kW (46HP)  AJY414GALH UNIT : AJY144/144/126GALH
135.0 kW (48HP)  AJY432GALH UNIT : AJY144/144/144GALH				

Energy efficiency combination

44.8 kW (16HP)  AJY144GALHH UNIT : AJYA72/A72GALH	62.4 kW (22HP)  AJY198GALHH UNIT : AJY126/A72GALH	67.2 kW (24HP)  AJY216GALHH UNIT : AJYA72/A72/A72GALH	72.8 kW (26HP)  AJY234GALHH UNIT : AJYA90/A72/A72GALH	78.4 kW (28HP)  AJY252GALHH UNIT : AJYA90/A90/A72GALH
84.0 kW (30HP)  AJY270GALHH UNIT : AJYA90/A90/A90GALH	90.4 kW (32HP)  AJY288GALHH UNIT : AJY126/A90/A72GALH	96.0 kW (34HP)  AJY306GALHH UNIT : AJY126/A90/A90GALH	102.4 kW (36HP)  AJY324GALHH UNIT : AJY126/126/A72GALH	108.0 kW (38HP)  AJY342GALHH UNIT : AJY126/126/A90GALH
113.0 kW (40HP)  AJY360GALHH UNIT : AJY144/126/A90GALH	120.0 kW (42HP)  AJY378GALHH UNIT : AJY126/126/126GALH	125.0 kW (44HP)  AJY396GALHH UNIT : AJY144/126/126GALH		

8,10,12HP : AJYA72GALH / AJYA90GALH / AJY108GALH
14,16HP : AJY126GALH / AJY144GALH

AIRSTAGE VR-II



Dimensions

(Unit : mm)



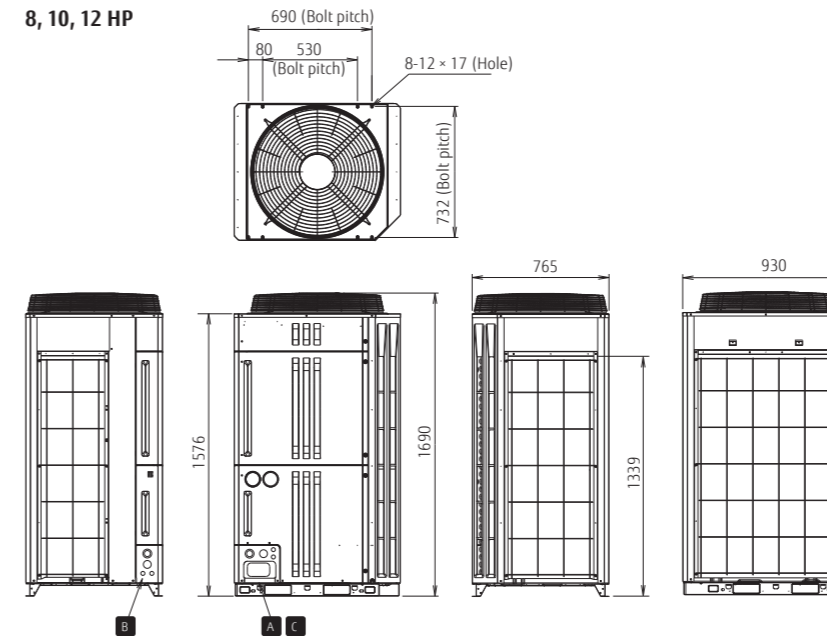



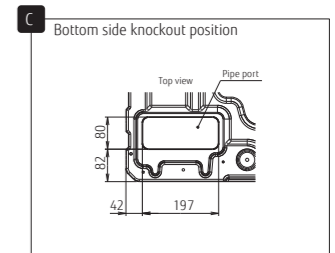
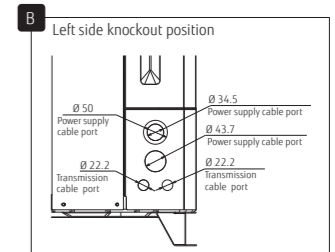
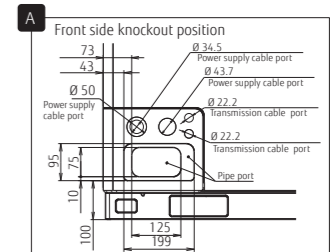
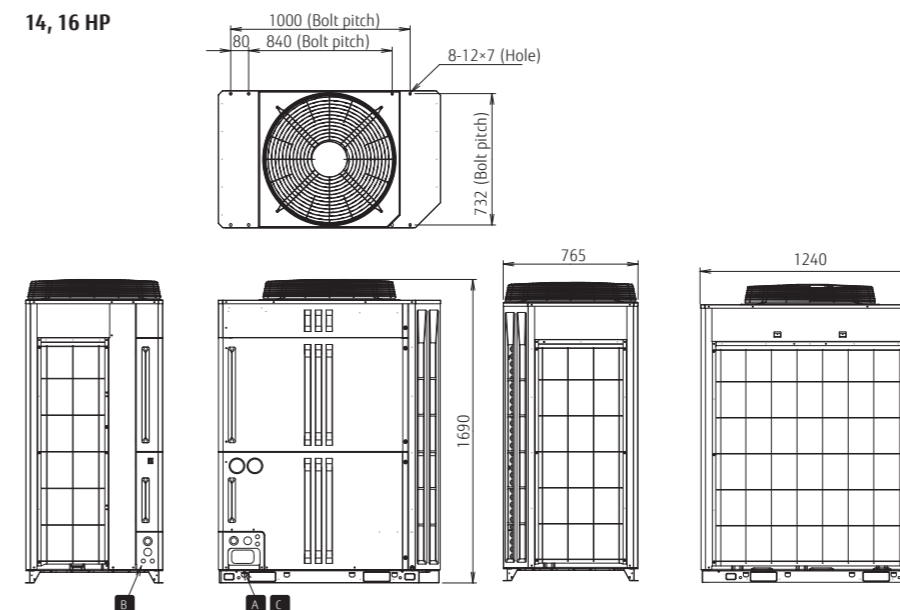

8, 10, 12 HP







14, 16 HP



Space Saving Combination

Rating Capacity range	HP	8	10	12	14	16	18	20	22	24	26	28	30	32	34	36	38	40	42	44	46	48		
																								
Set Model name		AJYA72GALH	AJYA90GALH	AJY108GALH	AJY126GALH	AJY144GALH	AJY162GALH	AJY180GALH	AJY198GALH	AJY216GALH	AJY234GALH		AJY252GALH	AJY270GALH	AJY288GALH	AJY306GALH	AJY324GALH	AJY342GALH	AJY360GALH	AJY378GALH	AJY396GALH	AJY414GALH	AJY432GALH	
Unit 1		AJYA72GALH	AJYA90GALH	AJY108GALH	AJY126GALH	AJY144GALH	AJYA90GALH	AJYA90GALH	AJY108GALH	AJY108GALH	AJY144GALH		AJY144GALH	AJY144GALH	AJY144GALH	AJY108GALH	AJY108GALH	AJY144GALH	AJY144GALH	AJY144GALH	AJY144GALH	AJY144GALH	AJY144GALH	AJY144GALH
Unit 2		AJYA72GALH	AJYA90GALH	AJY108GALH	AJY126GALH	AJY144GALH	AJYA90GALH	AJYA90GALH	AJY108GALH	AJY108GALH	AJY144GALH		AJY144GALH	AJY144GALH	AJY144GALH	AJY108GALH	AJY108GALH	AJY144GALH	AJY144GALH	AJY144GALH	AJY144GALH	AJY144GALH	AJY144GALH	AJY144GALH
Unit 3		AJYA72GALH	AJYA90GALH	AJY108GALH	AJY126GALH	AJY144GALH	AJYA90GALH	AJYA90GALH	AJY108GALH	AJY108GALH	AJY144GALH		AJY144GALH	AJY144GALH	AJY144GALH	AJY108GALH	AJY108GALH	AJY144GALH	AJY144GALH	AJY144GALH	AJY144GALH	AJY144GALH	AJY144GALH	AJY144GALH
Maximum Connectable Indoor Unit*		15	16	17	21	24	27	30	32	35	39		42	45	48	50	53	57	60	63	64	64	64	
Indoor unit connectable capacity	kW	11.2-33.6	14.0-42.0	16.8-50.2	20.0-60.0	22.5-67.5	25.2-75.6	28.0-84.0	30.8-92.2	33.5-100.5	36.5-109.5		39.3-117.7	42.5-127.5	45.0-135.0	47.5-142.5	50.3-150.7	53.3-159.7	56.0-168.0	59.0-177.0	61.8-185.2	65.0-195.0	67.5-202.5	
Power source		3-phase 4 wire, 400 V, 50Hz											3-phase 4 wire, 400 V, 50Hz											
Capacity	Cooling	22.4	28.0	33.5	40.0	45.0	50.4	56.0	61.5	67.0	73.0		78.5	85.0	90.0	95.0	100.5	106.5	112.0	118.0	123.5	130.0	135.0	
	Heating	25.0	31.5	37.5	45.0	50.0	56.5	63.0	69.0	75.0	81.5		87.5	95.0	100.0	106.5	112.5	119.0	125.0	131.5	137.5	145.0	150.0	
Input power	Cooling	5.45	7.11	9.75	11.34	13.61	12.56	14.22	16.86	19.50	20.72		23.36	24.95	27.22	26.61	29.25	30.47	33.11	34.33	36.97	38.56	40.83	
	Heating	5.70	7.33	9.62	10.90	12.77	13.03	14.66	16.95	19.24	20.10		22.39	23.67	25.54	26.57	28.86	29.72	32.01	32.87	35.16	36.44	38.31	
EER	Cooling	4.11	3.94	3.44	3.53	3.31	4.01	3.94	3.65	3.44	3.52		3.36	3.41	3.31	3.57	3.44	3.50	3.38	3.44	3.34	3.37	3.31	
COP	Heating	4.39	4.30	3.90	4.13	3.92	4.34	4.30	4.07	3.90	4.05		3.91	4.01	3.92	4.01	3.90	4.00	3.91	4.00	3.91	3.98	3.92	
Air flow rate		11,100	11,100	11,100	13,000	13,000	11,100×2	11,100×2	11,100×2	11,100×2	13,000+11,100		13,000+11,100	13,000×2	13,000×2	11,100×3	11,100×3	13,000+11,100×2	13,000+11,100×2	13,000+11,100	13,000+11,100	13,000×3	13,000×3	
Sound pressure level*	Cooling	56	58	59	60	61	60	61	62	62	63		63	64	64	65	66	65	66	65	66	66	66	
	Heating	58	59	61	61	61	62	62	63	64	63		64	64	64	65	66	65	66	65	66	66	66	
Maximum external static pressure		80	80	80	80	80	80	80	80	80	80		80	80	80	80	80	80	80	80	80	80	80	
Compressor motor output		7.5	7.5	7.5	11.0	11.0	7.5×2	7.5×2	7.5×2	7.5×2	11.0×7.5		11.0×7.5	11.0×2	11.0×2	7.5×3	7.5×3	11.0×7.5×2	11.0×7.5×2	11.0×7.5×2	11.0×7.5×2	11.0×3	11.0×3	
Heat exchanger fin		Blue fin	Blue fin	Blue fin	Blue fin	Blue fin	Blue fin	Blue fin	Blue fin	Blue fin	Blue fin		Blue fin	Blue fin	Blue fin	Blue fin	Blue fin	Blue fin	Blue fin	Blue fin	Blue fin	Blue fin	Blue fin	
Net Dimensions	Height	1,690	1,690	1,690	1,690	1,690	1,690	1,690	1,690	1,690	1,690		1,690	1,690	1,690	1,690	1,690	1,690	1,690	1,690	1,690	1,690	1,690	
	Width	930	930	930	1,240	1,240	930×2	930×2	930×2	930×2	1,240×930		1,240×930	1,240×2	1,240×2	930×3	930×3	1,240×2+930	1,240×2+930	1,240×3	1,240×3	1,240×3	1,240×3	
	Depth	765	765	765	765	765	765	765	765	765	765		765	765	765	765	765	765	765	765	765	765	765	
Weight		262	262	262	286	286	262×2	262×2	262×2	262×2	286+262		286+262	286×2	286×2	286×3	286×3	286+262×2	286+262×2	286×3	286×3	286×3	286×3	
Refrigerant	Type (Global Warming Potential)	R410A (2,088)	R410A (2,088)	R410A (2,088)	R410A (2,088)	R410A (2,088)	R410A (2,088)	R410A (2,088)	R410A (2,088)	R410A (2,088)	R410A (2,088)		R410A (2,088)	R410A (2,088)	R410A (2,088)	R410A (2,088)	R410A (2,088)	R410A (2,088)	R410A (2,088)	R410A (2,088)	R410A (2,088)	R410A (2,088)		
	Charge	11.8	11.8	11.8	11.8	11.8	11.8×2	11.8×2	11.8×2	11.8×2	11.8×2		11.8×2	11.8×2	11.8×3	11.8×3	11.8×3	11.8×3	11.8×3	11.8×3	11.8×3	11.8×3	11.8×3	
Connection pipe diameter	Liquid	12.70	12.70	12.70	12.70	12.70	15.88	15.88	15.88	15.88	15.88		15.88	15.88	19.05	19.05	19.05	19.05	19.05	19.05	19.05	19.05	19.05	
	Discharge Gas	15.88	19.05	19.05	22.22	22.22	22.22	22.22	22.22	22.22	28.58		28.58	28.58	28.58	28.58	28.58	34.92	34.92	34.92	34.92	34.92	34.92	
	Suction Gas	22.22	22.22	28.58	28.58	28.58	28.58	28.58	34.92	34.92	34.92		34.92	34.92	34.92	34.92	41.27	41.27	41.27	41.27	41.27	41.27	41.27	
Operation range	Cooling	-10 to 46	-10 to 46	-10 to 46	-10 to 46	-10 to 46	-10 to 46	-10 to 46	-10 to 46	-10 to 46	-10 to 46		-10 to 46	-10 to 46	-10 to 46	-10 to 46	-10 to 46	-10 to 46	-10 to 46	-10 to 46	-10 to 46	-10 to 46		
	Heating	-20 to 21	-20 to 21	-20 to 21	-20 to 21	-20 to 21	-20 to 21	-20 to 21	-20 to 21	-20 to 21	-20 to 21		-20 to 21	-20 to 21	-20 to 21	-20 to 21	-20 to 21	-20 to 21	-20 to 21	-20 to 21	-20 to 21	-20 to 21		
	Cooling/Heating	-10 to 21	-10 to 21	-10 to 21	-10 to 21	-10 to 21	-10 to 21	-10 to 21	-10 to 21	-10 to 21	-10 to 21		-10 to 21	-10 to 21	-10 to 21	-10 to 21	-10 to 21	-10 to 21	-10 to 21	-10 to 21	-10 to 21	-10 to 21		

Energy Efficiency Combination

Rating Capacity range	HP	16	22	24	26	28	30	32	34	36	38	40	42	44	
															
Set Model name		AJY144GALHH	AJY198GALHH	AJY216GALHH	AJY234GALHH	AJY252GALHH	AJY270GALHH	AJY288GALHH		AJY306GALHH	AJY324GALHH	AJY342GALHH	AJY360GALHH	AJY378GALHH	AJY396GALHH
Unit 1		AJYA72GALH	AJY126GALH	AJYA72GALH	AJYA90GALH	AJYA90GALH	AJYA90GALH	AJY126GALH		AJY126GALH	AJY126GALH	AJY126GALH	AJY144GALH	AJY126GALH	AJY144GALH
Unit 2		AJYA72GALH	AJYA72GALH	AJYA72GALH	AJYA90GALH	AJYA90GALH	AJYA90GALH	AJYA90GALH		AJYA90GALH	AJYA90GALH	AJYA90GALH	AJY126GALH	AJY126GALH	AJY126GALH
Unit 3		AJYA72GALH	AJYA72GALH	AJYA72GALH	AJYA90GALH	AJYA90GALH	AJYA90GALH	AJYA90GALH		AJYA90GALH	AJYA90GALH	AJYA90GALH	AJY126GALH	AJY126GALH	AJY126GALH
Maximum Connectable Indoor Unit*		24	33	36	39	42	45	48		51	54	57	60	64	
Indoor unit connectable capacity	kW	22.4-67.2	31.2-93.6	33.6-100.8	36.4-109.2	39.2-117.6	42.0-126.0	45.2-135.6		48.0-144.0	51.2-153.6	54.0-162.0	56.5-169.5	60.0-180.0	62.5-187.5
Power source		3-phase 4 wire, 400 V, 50Hz							3-phase 4 wire, 400 V, 50Hz						
Capacity	Cooling	44.8	62.4	67.2	72.8	78.4	84.0	90.4		96.0	102.4	108.0	113.0	120.0	125.0
	Heating	50.0	70.0	75.0	81.5	88.0	94.5	101.5		108.0	115.0	121.5	126.5	135.0	140.0
Input power	Cooling	10.90	16.79	16.35	18.01	19.67	21.33	23.90		25.56	28.13	29.79	32.06	34.02	36.29
	Heating	11.40	16.60	17.10	18.73	20.36	21.99	23.93		25.56	27.50	29.13	31.00	32.70	34.57
EER	Cooling	4.11	3.72	4.11	4.04	3.99	3.94	3.78		3.76	3.64	3.63	3.52	3.53	3.44
COP	Heating	4.39	4.22	4.39	4.35	4.32	4.30	4.24		4.23	4.18	4.17	4.08	4.13	4.05
Air flow rate		11,100×2	13,000+11,100	11,100×3	11,100×3	11,100×3	11,100×3	13,000+11,100×2		13,000+11,100×2	13,000×2+11,100	13,000×2+11,100	13,000×2+11,100	13,000×3	13,000×3
Sound pressure level*	Cooling	59	61	62	63	63	64	64		64	65	65	65	66	66
	Heating	61	63	63	63	63	64	64		65	65	65	65	66	66
Maximum external static pressure		80	80	80	80	80	80	80		80	80	80	80	80	80
Compressor motor output		7.5×2	11.0×7.5	7.5×3	7.5×3	7.5×3	7.5×3	11.0×7.5×2		11.0×7.5×2	11.0×2+7.5	11.0×2+7.5	11.0×2+7.5	11.0×3	11.0×3
Heat exchanger fin		Blue fin	Blue fin	Blue fin	Blue fin	Blue fin	Blue fin	Blue fin		Blue fin	Blue fin	Blue fin	Blue fin	Blue fin	Blue fin
Net Dimensions	Height	1,690	1,690	1,690	1,690	1,690	1,690	1,690		1,690	1,690	1,690	1,690	1,690	1,690
	Width	930×2	1,240×930	930×3	930×3	930×3	930×3	1,240×930×2		1,240×930×2	1,240×2+930	1,240×2+930	1,240×3	1,240×3	
	Depth	765	765	765	765	765	765	765		765	765	765	765	765	
Weight		262×2	286+262	262×3	262×3	262×3	262×3	286+262×2		286+262×2	286×2+262	286×2+262	286×3	286×3	
Refrigerant	Type (Global Warming Potential)	R410A (2,088)	R410A (2,088)	R410A (2,088)	R410A (2,088)	R410A (2,088)	R410A (2,088)	R4							

Heat Pump Modular Type



Smart and cutting edge design
 Extensive lineup from 8HP to 48HP in 2HP increment
 Connectable indoor unit capacity ratio up to 150%



System Outline

Excellent energy saving

Heat pump inverter type realizes the highly energy saving air conditioning for individual cooling and heating operation by all inverter technology for seasonal efficiency.

High design flexibility for various building air conditioning

High design flexibly meets the various needs of high-rise building air conditioning such as outdoor unit roof top concentrated installation and each floor installation by large capacity combination, sufficient connection capacity, and high static pressure design.

Easy installation and maintenance

The flexible communication method and piping connections makes installation and maintenance easy even for large systems.



Features

Efficiency in actual operation

Top class high COP is achieved for all combinations by our unique heat exchanger structure, high efficient DC twin compressor, and our own technologies.

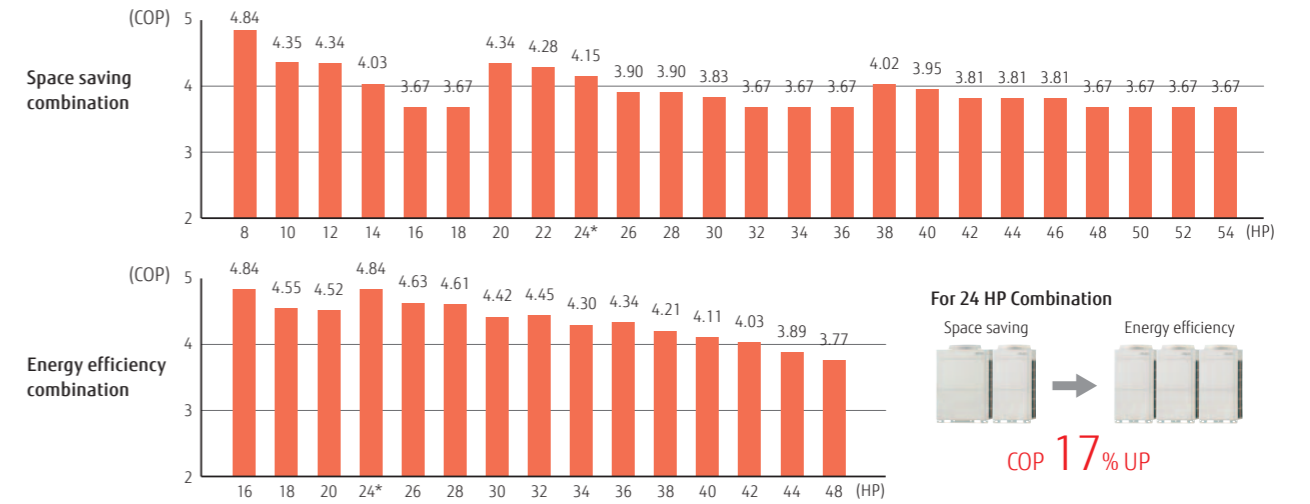

Energy saving technology that boosted operation efficiency



Powerful large propeller fan

By using CFD** technology, a newly designed fan achieves high performance and low noise operation.
 *1. CFD = Computational Fluid Dynamics



3 phase DC fan motor

Efficiency is substantially improved by high efficient motor with sophisticated driver control. In addition, low noise is realized by DC fan motor.



Subcool heat exchanger

High Heat Exchange efficiency is achieved by using an internal projection shape double pipe construction.



Sine-wave DC inverter control

High efficiency is realized by adoption of reduced switching loss IPM.



High efficient and large capacity DC inverter compressor

Large capacity high efficient DC twin rotary compressor with excellent intermediate capability.



4-face heat exchanger

Heat exchange efficiency is significantly improved by the introduction of a new 4-face heat exchanger that increases effective surface area.

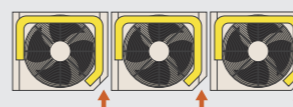















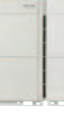

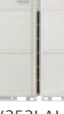
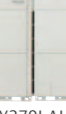
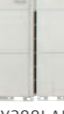
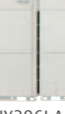
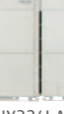



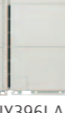
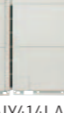



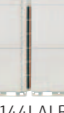

Front intake port (corner cut air inhaling structure)

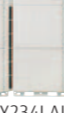
In multiple outdoor unit installations, the unique front intake design improves airflow into the Heat Exchanger.

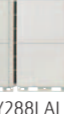
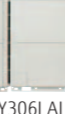
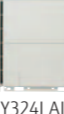
Outdoor units lineup

• Combinations other than the followings are not recommended.

Space saving combination				
22.4 kW (8HP)  AJY072LALBH UNIT : AJY072LALBH	28.0 kW (10HP)  AJY090LALBH UNIT : AJY090LALBH	33.5 kW (12HP)  AJY108LALBH UNIT : AJY108LALBH	40.0 kW (14HP)  AJY126LALBH UNIT : AJY126LALBH	45.0 kW (16HP)  AJY144LALBH UNIT : AJY144LALBH
50.0 kW (18HP)  AJY162LALBH UNIT : AJY162LALBH	56.0 kW (20HP)  AJY180LALBH UNIT : AJY090/090LALBH	62.4 kW (22HP)  AJY198LALBH UNIT : AJY126/072LALBH	68.0 kW (24HP)  AJY216LALBH UNIT : AJY126/090LALBH	73.0 kW (26HP)  AJY234LALBH UNIT : AJY144/090LALBH
78.0 kW (28HP)  AJY252LALBH UNIT : AJY162/090LALBH	85.0 kW (30HP)  AJY270LALBH UNIT : AJY144/126LALBH	90.0 kW (32HP)  AJY288LALBH UNIT : AJY144/144LALBH	95.0 kW (34HP)  AJY306LALBH UNIT : AJY162/144LALBH	100.0 kW (36HP)  AJY324LALBH UNIT : AJY162/162LALBH
106.0 kW (38HP)  AJY342LALBH UNIT : AJY162/090/090LALBH	113.0 kW (40HP)  AJY360LALBH UNIT : AJY144/126/090LALBH	118.0 kW (42HP)  AJY378LALBH UNIT : AJY144/144/090LALBH	123.0 kW (44HP)  AJY396LALBH UNIT : AJY162/144/090LALBH	128.0 kW (46HP)  AJY414LALBH UNIT : AJY162/162/090LALBH
135.0 kW (48HP)  AJY432LALBH UNIT : AJY144/144/144LALBH	140.0 kW (50HP)  AJY450LALBH UNIT : AJY162/144/144LALBH	145.0 kW (52HP)  AJY468LALBH UNIT : AJY162/162/144LALBH	150.0 kW (54HP)  AJY486LALBH UNIT : AJY162/162/162LALBH	

Energy efficiency combination				
44.8 kW (16HP)  AJY144LALBHH UNIT : AJY072/072LALBH	50.4 kW (18HP)  AJY162LALBHH UNIT : AJY090/072LALBH	55.9 kW (20HP)  AJY180LALBHH UNIT : AJY108/072LALBH	67.2 kW (24HP)  AJY216LALBHH UNIT : AJY072/072/072LALBH	72.8 kW (26HP)  AJY234LALBHH UNIT : AJY090/072/072LALBH
78.3 kW (28HP)  AJY252LALBHH UNIT : AJY108/072/072LALBH	84.8 kW (30HP)  AJY270LALBHH UNIT : AJY126/072/072LALBH	89.4 kW (32HP)  AJY288LALBHH UNIT : AJY108/108/072LALBH	95.9 kW (34HP)  AJY306LALBHH UNIT : AJY126/108/072LALBH	100.5 kW (36HP)  AJY324LALBHH UNIT : AJY108/108/108LALBH
107.0 kW (38HP)  AJY342LALBHH UNIT : AJY126/108/108LALBH	113.5 kW (40HP)  AJY360LALBHH UNIT : AJY126/126/108LALBH	120.0 kW (42HP)  AJY378LALBHH UNIT : AJY126/126/126LALBH	125.0 kW (44HP)  AJY396LALBHH UNIT : AJY144/126/126LALBH	130.0 kW (46HP)  AJY414LALBHH UNIT : AJY144/144/126LALBH

8,10HP : AJY072LALBH / AJY090LALBH
12,14,16HP : AJY108LALBH / AJY126LALBH / AJY144LALBH / AJY162LALBH



Dimensions (Unit : mm)

8, 10 HP

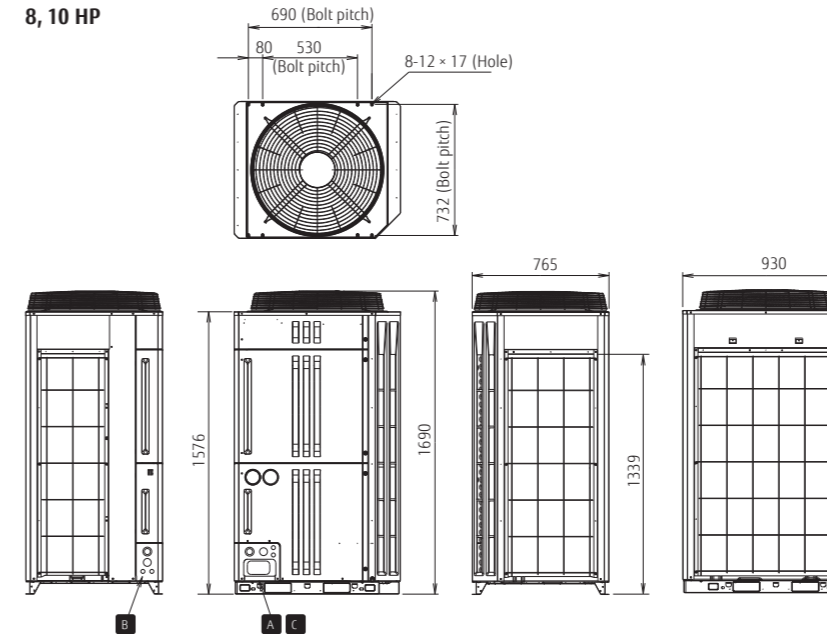

12, 14, 16 HP

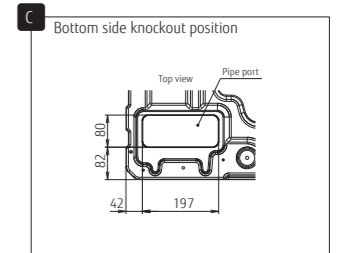
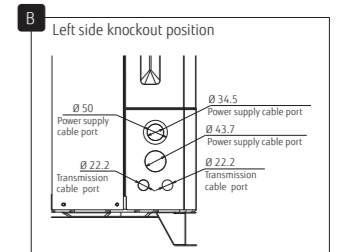
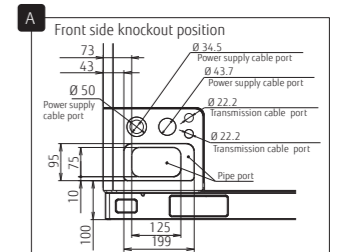
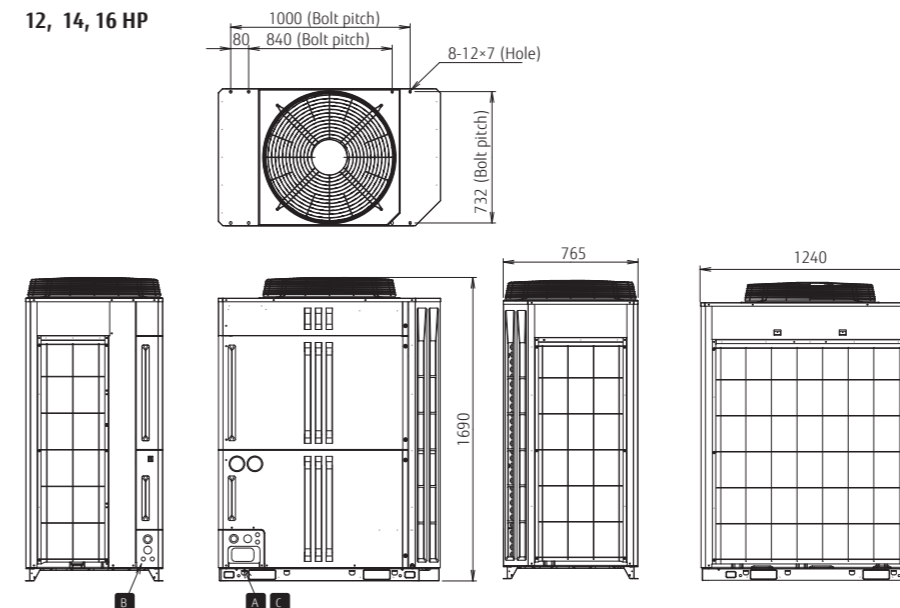

Heat Pump Modular Type

AIRSTAGE™ V-II

Smart and cutting edge design
 Extensive lineup from 8HP to 48HP in 2HP increment
 Connectable indoor unit capacity ratio up to 150%

System Outline

Excellent energy savings

Heat pump type inverter control is used to achieve economic cooling and heating operation for individual air conditioning to entire air conditioning.

High design flexibility for various building air conditioning

The high static pressure design flexibly meets the needs of high rise buildings including easy installation on each floor.

Easy installation and maintenanc

The flexible communication method and piping connections makes installation and maintenance easy even for large systems.



Features

Efficiency in actual operation

Top class high COP is achieved for all combinations by our unique heat exchanger structure, high efficient DC twin compressor, and our own technologies.

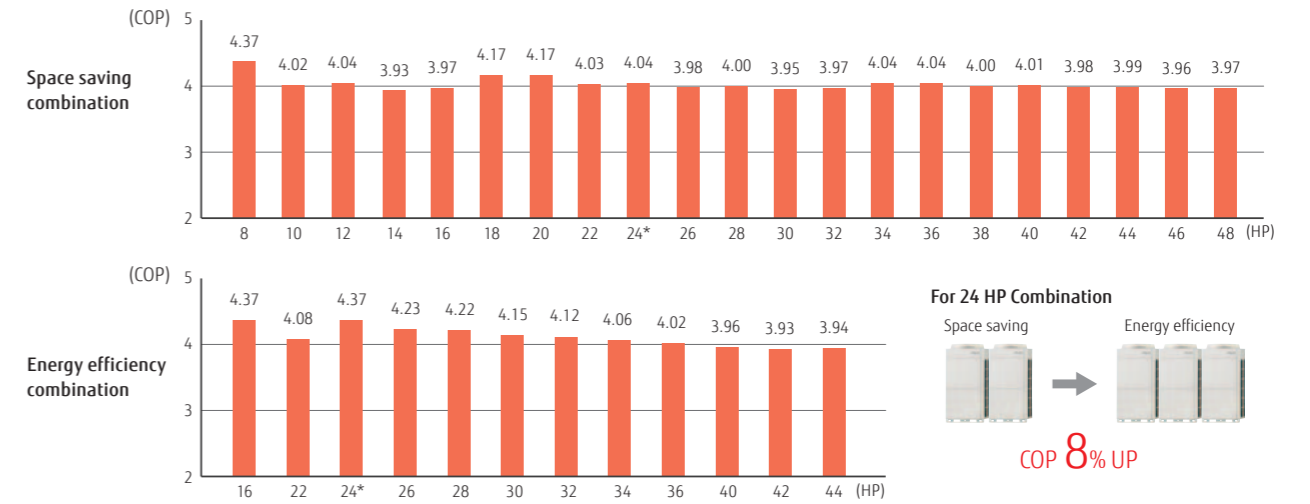



















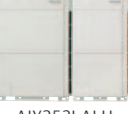

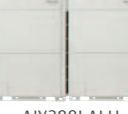
Energy saving technology that boosted operation efficiency

- Powerful large propeller fan**
 By using CFD^{*1} technology, a newly designed fan achieves high performance and low noise operation.
*1. CFD = Computational Fluid Dynamics
- DC fan motor**
 Power consumption has been reduced by 25% compared to previous models by using a compact and high performance DC fan motor.
- Subcool heat exchanger**
 High Heat Exchange efficiency is achieved by using an internal projection shape double pipe construction.
- Sine-wave DC inverter control**
 High efficiency operation is realized by using a sine wave DC inverter control.
- DC twin rotary compressor**
 Significantly greater efficiency is realized by use of a large capacity DC twin rotary compressor with substantially increased refrigerant intake and compression efficiency.
- 4-face heat exchanger**
 Heat exchange efficiency is significantly improved by the introduction of a new 4-face heat exchanger that increases effective surface area.
- Front intake port (corner cut air inhaling structure)**
 In multiple outdoor unit installations, the unique front intake design improves airflow into the Heat Exchanger.

Outdoor units lineup

• Combinations other than the followings are not recommended.

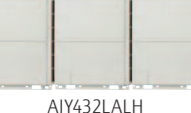
Space saving combination				
22.4 kW (8HP)  AJYA72LALH UNIT : AJYA72LALH	28.0 kW (10HP)  AJYA90LALH UNIT : AJYA90LALH	33.5 kW (12HP)  AJY108LALH UNIT : AJY108LALH	40.0 kW (14HP)  AJY126LALH UNIT : AJY126LALH	45.0 kW (16HP)  AJY144LALH UNIT : AJY144LALH
50.4 kW (18HP)  AJY162LALH UNIT : AJYA90/A72LALH	56.9 kW (20HP)  AJY180LALH UNIT : AJY108/A72LALH	61.5 kW (22HP)  AJY198LALH UNIT : AJY108/A90LALH	67.0 kW (24HP)  AJY216LALH UNIT : AJY108/108LALH	73.5 kW (26HP)  AJY234LALH UNIT : AJY126/108LALH
78.5 kW (28HP)  AJY252LALH UNIT : AJY144/108LALH	85.0 kW (30HP)  AJY270LALH UNIT : AJY144/126LALH	90.0 kW (32HP)  AJY288LALH UNIT : AJY144/144LALH	95.0 kW (34HP)  AJY306LALH UNIT : AJY108/108/A90LALH	100.5 kW (36HP)  AJY324LALH UNIT : AJY108/108/108LALH
107.0 kW (38HP)  AJY342LALH UNIT : AJY126/108/108LALH	112.0 kW (40HP)  AJY360LALH UNIT : AJY144/108/108LALH	118.5 kW (42HP)  AJY378LALH UNIT : AJY144/126/108LALH	123.5 kW (44HP)  AJY396LALH UNIT : AJY144/144/108LALH	130.0 kW (46HP)  AJY414LALH UNIT : AJY144/144/126LALH
135.0 kW (48HP)  AJY432LALH UNIT : AJY144/144/144LALH				

Energy efficiency combination				
44.8 kW (16HP)  AJY144LALHH UNIT : AJYA72/A72LALH	62.4 kW (22HP)  AJY198LALHH UNIT : AJY126/A72LALH	67.2 kW (24HP)  AJY216LALHH UNIT : AJYA72/A72/A72LALH	72.8 kW (26HP)  AJY234LALHH UNIT : AJYA90/A72/A72LALH	78.4 kW (28HP)  AJY252LALHH UNIT : AJY108/A72/A72LALH
84.8 kW (30HP)  AJY270LALHH UNIT : AJY126/A72/A72LALH	89.8 kW (32HP)  AJY288LALHH UNIT : AJY108/108/A72LALH	95.9 kW (34HP)  AJY306LALHH UNIT : AJY126/108/A72LALH	102.4 kW (36HP)  AJY324LALHH UNIT : AJY126/126/A72LALH	113.5 kW (40HP)  AJY360LALHH UNIT : AJY126/126/108LALH
120.0 kW (42HP)  AJY378LALHH UNIT : AJY126/126/126LALH	125.0 kW (44HP)  AJY396LALHH UNIT : AJY144/126/126LALH			

8,10,12HP : AJYA72LALH / AJYA90LALH / AJY108LALH
14,16HP : AJY126LALH / AJY144LALH



Dimensions

(Unit : mm)

8, 10, 12 HP

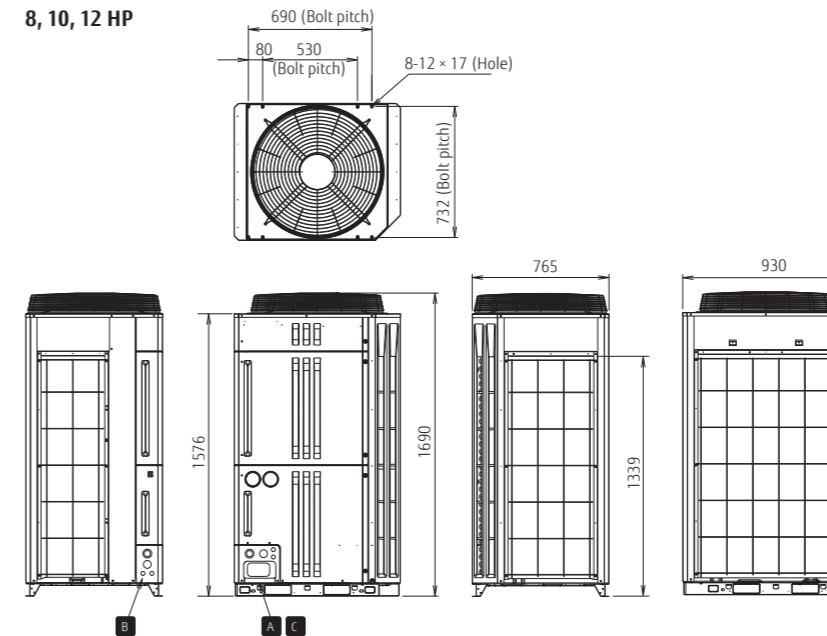

14, 16 HP

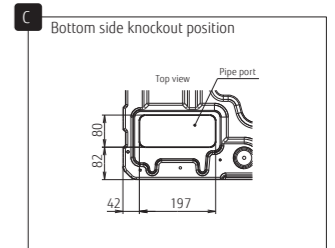
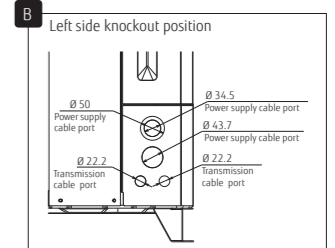
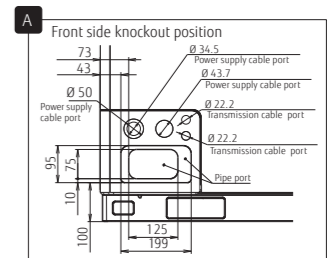
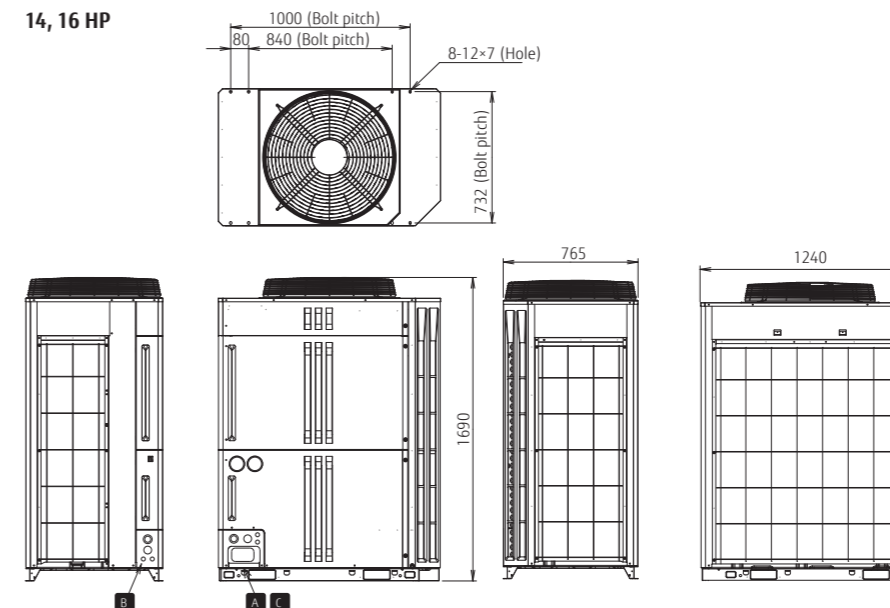

Space Saving Combination

Rating Capacity range	HP	8	10	12	14	16	18	20	22	24	26	28	30	32	34	36	38	40	42	44	46	48	
Set Model name		AJYA72LALH	AJYA90LALH	AJY108LALH	AJY126LALH	AJY144LALH	AJY162LALH	AJY180LALH	AJY198LALH	AJY216LALH	AJY234LALH	AJY252LALH	AJY270LALH	AJY288LALH	AJY306LALH	AJY324LALH	AJY342LALH	AJY360LALH	AJY378LALH	AJY396LALH	AJY414LALH	AJY432LALH	
Unit 1		AJYA72LALH	AJYA90LALH	AJY108LALH	AJY126LALH	AJY144LALH	AJYA90LALH	AJY108LALH	AJY108LALH	AJY108LALH	AJY126LALH	AJY144LALH	AJY144LALH	AJY144LALH	AJY108LALH	AJY108LALH	AJY126LALH	AJY144LALH	AJY144LALH	AJY144LALH	AJY144LALH	AJY144LALH	AJY144LALH
Unit 2							AJYA90LALH	AJY108LALH	AJY108LALH	AJY108LALH	AJY126LALH	AJY144LALH	AJY144LALH	AJY144LALH	AJY108LALH	AJY108LALH	AJY126LALH	AJY144LALH	AJY144LALH	AJY144LALH	AJY144LALH	AJY144LALH	
Unit 3																							
Maximum Connectable Indoor Unit*		15	16	17	21	24	32	32	32	35	39	42	45	48	48	48	48	48	48	48	48	48	
Indoor unit connectable capacity	kW	11.2-33.6	14.0-42.0	16.8-50.2	20.0-60.0	22.5-67.5	25.2-75.6	28.0-83.8	30.8-92.2	33.5-100.5	36.8-110.2	39.3-117.7	42.5-127.5	45.0-135.0	47.5-142.5	50.3-150.7	53.5-160.5	56.0-168.0	59.3-177.7	61.8-185.2	65.0-195.0	67.5-202.5	
Power source		3-phase 4 wire, 400 V, 50Hz										3-phase 4 wire, 400 V, 50Hz											
Capacity	Cooling	22.4	28.0	33.5	40.0	45.0	50.4	55.9	61.5	67.0	73.5	78.5	85.0	90.0	95.0	100.5	107.0	112.0	118.5	123.5	130.0	135.0	
	Heating	25.0	31.5	37.5	45.0	50.0	56.5	62.5	69.0	75.0	82.5	87.5	95.0	100.0	106.5	112.5	120.0	125.0	132.5	137.5	145.0	150.0	
Input power	Cooling	5.51	7.73	9.62	11.53	14.17	13.24	15.13	17.35	19.24	21.15	23.79	25.70	28.34	26.97	28.86	30.77	33.41	35.32	37.96	39.87	42.51	
	Heating	5.72	7.83	9.28	11.45	12.60	13.55	15.00	17.11	18.56	20.73	21.88	24.05	25.20	26.39	27.84	30.01	31.16	33.33	34.48	36.65	37.80	
EER	Cooling	4.07	3.62	3.48	3.47	3.18	3.81	3.69	3.54	3.48	3.48	3.30	3.31	3.18	3.52	3.48	3.48	3.35	3.36	3.25	3.26	3.18	
COP	Heating	4.37	4.02	4.04	3.93	3.97	4.17	4.17	4.03	4.04	3.98	4.00	3.95	3.97	4.04	4.04	4.00	4.01	3.98	3.99	3.96	3.97	
Air flow late	High	11,100	11,100	11,100	13,000	13,000	11,100 × 2	11,100 × 2	11,100 × 2	11,100 × 2	13,000 + 11,100	13,000 + 11,100	13,000 × 2	13,000 × 2	11,100 × 3	11,100 × 3	13,000 + 11,100 × 2	13,000 + 11,100 × 2	13,000 × 2 + 11,100	13,000 × 2 + 11,100	13,000 × 3	13,000 × 3	
	Cooling	56	58	58	60	61	60	60	61	61	62	63	64	64	63	63	64	64	65	65	65	66	
	Heating	58	59	60	61	61	62	62	63	63	64	64	64	64	64	65	65	65	65	65	66	66	
Maximum external static pressure	Pa	80	80	80	80	80	80	80	80	80	80	80	80	80	80	80	80	80	80	80	80	80	
Compressor motor output	kW	3.9	3.9	3.9 + 4.5	3.9 + 4.5	3.9 + 4.5	3.9 × 2	3.9 × 2 + 4.5	3.9 × 2 + 4.5	3.9 × 2 + 4.5	3.9 × 2 + 4.5 × 2	3.9 × 2 + 4.5 × 2	3.9 × 2 + 4.5 × 2	3.9 × 2 + 4.5 × 2	3.9 × 3 + 4.5 × 3	3.9 × 3 + 4.5 × 3	3.9 × 3 + 4.5 × 3	3.9 × 3 + 4.5 × 3	3.9 × 3 + 4.5 × 3	3.9 × 3 + 4.5 × 3	3.9 × 3 + 4.5 × 3	3.9 × 3 + 4.5 × 3	
Heat exchanger fin		Blue fin	Blue fin	Blue fin	Blue fin	Blue fin	Blue fin	Blue fin	Blue fin	Blue fin	Blue fin	Blue fin	Blue fin	Blue fin	Blue fin	Blue fin	Blue fin	Blue fin	Blue fin	Blue fin	Blue fin	Blue fin	
Net Dimensions	Height	1,690	1,690	1,690	1,690	1,690	1,690	1,690	1,690	1,690	1,690	1,690	1,690	1,690	1,690	1,690	1,690	1,690	1,690	1,690	1,690	1,690	
	Width	930	930	930	1,240	1,240	930 × 2	930 × 2	930 × 2	930 × 2	930 × 1,240	930 × 1,240	1,240 × 2	1,240 × 2	930 × 3	930 × 3	930 × 2 + 1,240	930 × 2 + 1,240	930 × 2 + 1,240	930 × 2 + 1,240	930 × 2 + 1,240	1,240 × 3	
	Depth	765	765	765	765	765	765	765	765	765	765	765	765	765	765	765	765	765	765	765	765	765	
Weight	kg	220	220	275	303	303	220 + 220	275 + 220	275 + 220	275 + 220	303 + 275	303 + 275	303 + 303	296 + 296	275 + 275 + 220	275 + 275 + 275	303 + 275 + 275	303 + 275 + 275	303 + 303 + 275	303 + 303 + 275	303 + 303 + 303	303 + 303 + 303	
Refrigerant	Type (Global Warming Potential)	R410A (2,088)	R410A (2,088)	R410A (2,088)	R410A (2,088)	R410A (2,088)	R410A (2,088)	R410A (2,088)	R410A (2,088)	R410A (2,088)	R410A (2,088)	R410A (2,088)	R410A (2,088)	R410A (2,088)	R410A (2,088)	R410A (2,088)	R410A (2,088)	R410A (2,088)	R410A (2,088)	R410A (2,088)	R410A (2,088)	R410A (2,088)	
	Charge	11.2	11.2	11.8	11.8	11.8	11.2 × 2	11.8 + 11.2	11.8 + 11.2	11.8 × 2	11.8 × 2	11.8 × 2	11.8 × 2	11.8 × 2	11.8 × 2 + 11.2	11.8 × 3	11.8 × 3	11.8 × 3	11.8 × 3	11.8 × 3	11.8 × 3	11.8 × 3	
Connection pipe diameter	Liquid	12.70	12.70	12.70	12.70	12.70	15.88	15.88	15.88	15.88	15.88	15.88	19.05	19.05	19.05	19.05	19.05	19.05	19.05	19.05	19.05	19.05	
	Gas	22.22	22.22	28.58	28.58	28.58	28.58	28.58	34.92	34.92	34.92	34.92	34.92	34.92	34.92	41.27	41.27	41.27	41.27	41.27	41.27	41.27	
Operation range	Cooling	-15 to 46	-15 to 46	-15 to 46	-15 to 46	-15 to 46	-5 to 46	-5 to 46	-5 to 46	-5 to 46	-5 to 46	-5 to 46	-5 to 46	-5 to 46	-5 to 46	-5 to 46	-5 to 46	-5 to 46	-5 to 46	-5 to 46	-5 to 46	-5 to 46	
	Heating	-20 to 21	-20 to 21	-20 to 21	-20 to 21	-20 to 21	-20 to 21	-20 to 21	-20 to 21	-20 to 21	-20 to 21	-20 to 21	-20 to 21	-20 to 21	-20 to 21	-20 to 21	-20 to 21	-20 to 21	-20 to 21	-20 to 21	-20 to 21	-20 to 21	

Energy Efficiency Combination

Rating Capacity range	HP	16	22	24	26	28	30	32	34	36	40	42	44
Set Model name		AJY144LALHH	AJY198LALHH	AJY216LALHH	AJY234LALHH	AJY252LALHH	AJY270LALHH	AJY288LALHH	AJY306LALHH	AJY324LALHH	AJY360LALHH	AJY378LALHH	AJY396LALHH
Unit 1		AJYA72LALH	AJY126LALH	AJYA72LALH	AJYA90LALH	AJY108LALH	AJY126LALH	AJY108LALH	AJY126LALH	AJY126LALH	AJY126LALH	AJY126LALH	AJY144LALH
Unit 2		AJYA72LALH	AJYA72LALH	AJYA72LALH	AJYA72LALH	AJYA72LALH	AJYA72LALH	AJY108LALH	AJY126LALH	AJY126LALH	AJY126LALH	AJY126LALH	AJY126LALH
Unit 3								AJYA72LALH	AJYA72LALH	AJYA72LALH	AJY108LALH	AJY126LALH	
Maximum Connectable Indoor Unit*		30	33	36	39	42	45	48	48	48	48	48	48
Indoor unit connectable capacity	kW	22.4-67.2	31.2-93.6	33.6-100.8	36.4-109.2	39.2-117.4	42.4-127.2	44.7-134.1	48.0-143.8	51.2-153.6	56.8-170.2	60.0-180.0	62.5-187.5
Power source		3-phase 4 wire, 400 V, 50Hz						3-phase 4 wire, 400 V, 50Hz					
Capacity	Cooling	44.8	62.4	67.2	72.8	78.3	84.8	89.4	95.9	102.4	113.5	120.0	125.0
	Heating	50.0	70.0	75.0	81.5	87.5	95.0	100.0	107.5	115.0	127.5	135.0	140.0
Input power	Cooling	11.02	17.04	16.53	18.75	20.64	22.55	24.75	26.66	28.57	32.68	34.59	37.23
	Heating	11.44	17.17	17.16	19.27	20.72	22.89	24.28	26.45	28.62	32.18	34.35	35.50
EER	Cooling	4.07	3.66	4.07	3.88	3.79	3.76	3.61	3.60	3.58	3.47	3.47	3.36
COP	Heating	4.37	4.08	4.37	4.23	4.22	4.15	4.12	4.06	4.02	3.96	3.93	3.94
Air flow late	High	11,100 × 2	13,000 + 11,100	11,100 × 3	11,100 × 3	11,100 × 3	13,000 + 11,000 × 2	11,100 × 3	13,000 + 11,100 × 2	13,000 × 2 + 11,100	13,000 × 2 + 11,100	13,000 × 3	13,000 × 3
	Cooling	59	61	61	62	62	63	62	63	64	64	65	65
	Heating	59	62	61	62	63	63	64	64	65	65	66	66
Maximum external static pressure	Pa	80	80	80	80	80	80	80	80	80	80	80	80
Compressor motor output	kW	3.9 × 2	3.9 × 2 + 4.5	3.9 × 3	3.9 × 3	3.9 × 3 + 4.5	3.9 × 3 + 4.5	3.9 × 3 + 4.5 × 2	3.9 × 3 + 4.5 × 2	3.9 × 3 + 4.5 × 2	3.9 × 3 + 4.5 × 3	3.9 × 3 + 4.5 × 3	3.9 × 3 + 4.5 × 3
Heat exchanger fin		Blue fin	Blue fin	Blue fin	Blue fin	Blue fin	Blue fin	Blue fin	Blue fin	Blue fin	Blue fin	Blue fin	Blue fin
Net Dimensions	Height	1,690	1,690	1,690	1,690	1,690	1,690	1,690	1,690	1,690	1,690	1,690	1,690
	Width	930 × 2	930 + 1,240	930 × 3	930 × 3	930 × 3	930 × 2 + 1,240	930 × 3	930 × 2 + 1,240	930 + 1,240 × 2	930 + 1,240 × 2	1,240 × 3	1,240 × 3
	Depth	765	765	765	765	765	765	765	765	765	765	765	765
Weight	kg	220 + 220	303 + 220	220 + 220 + 220	220 + 220 + 220	275 + 220 + 220	303 + 220 + 220	275 + 275 + 220	303 + 275 + 220	303 + 303 + 220	303 + 303 + 275	303 + 303 + 303	303 + 303 + 303
Refrigerant	Type (Global Warming Potential)	R410A (2,088)	R410A (2,088)	R410A (2,088)	R410A (2,088)	R410A (2,088)	R410A (2,088)	R410A (2,088)	R410A (2,088)	R410A (2,088)	R410A (2,088)	R410A (2,088)	R410A (2,088)
	Charge	11.2 × 2	11.8 + 11.2	11.2 × 3	11.2 × 3	11.8 + 11.2 × 2	11.8 + 11.2 × 2	11.8 × 2 + 11.2	11.8 × 2 + 11.2	11.8 × 2 + 11.2	11.8 × 3	11.8 × 3	11.8 × 3
Connection pipe diameter	Liquid	12.70	15.88	15.88	15.88	15.88	19.05	19.05	19.05	19			

NEW

Heat Pump for Small Capacity Type

AIRSTAGE™ J-III

Fujitsu General provides air conditioning systems for a wide range of applications from small office buildings and stores to large houses.



System Outline

High Energy Efficiency

Heat pump inverter control is used to achieve an efficient cooling and heating operation in any indoor unit combination.

Flexible systems for small- and medium-size buildings air conditioning

Space saving design and long piping design allow for flexible installation on the roofs or balconies of small and medium-size buildings. Multiple indoor units of various capacities and types can be connected.



Features

Efficiency in actual operation

Top class high COP is achieved for all models by large heat exchanger, high efficient DC twin compressor, and our own technologies.

High EER / COP

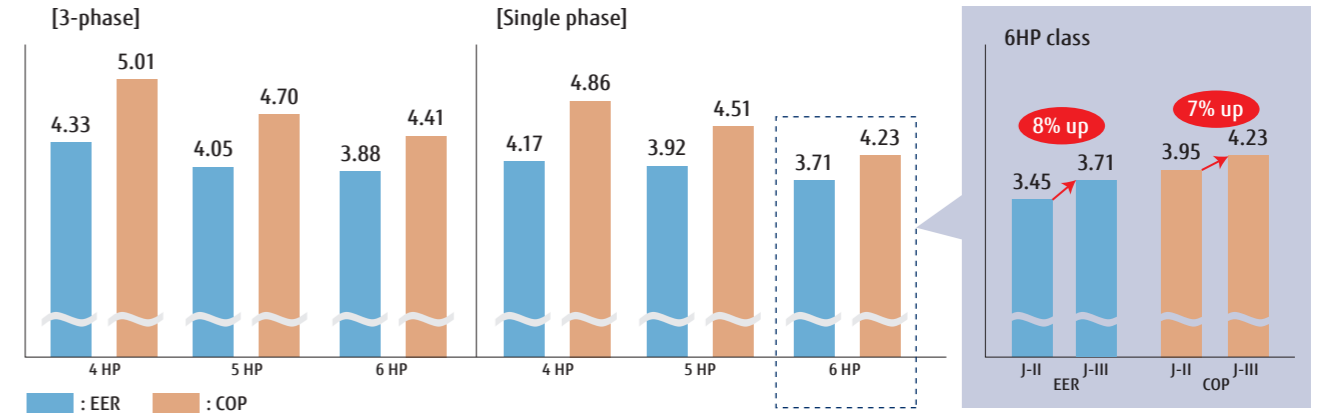

Advanced high efficiency technology

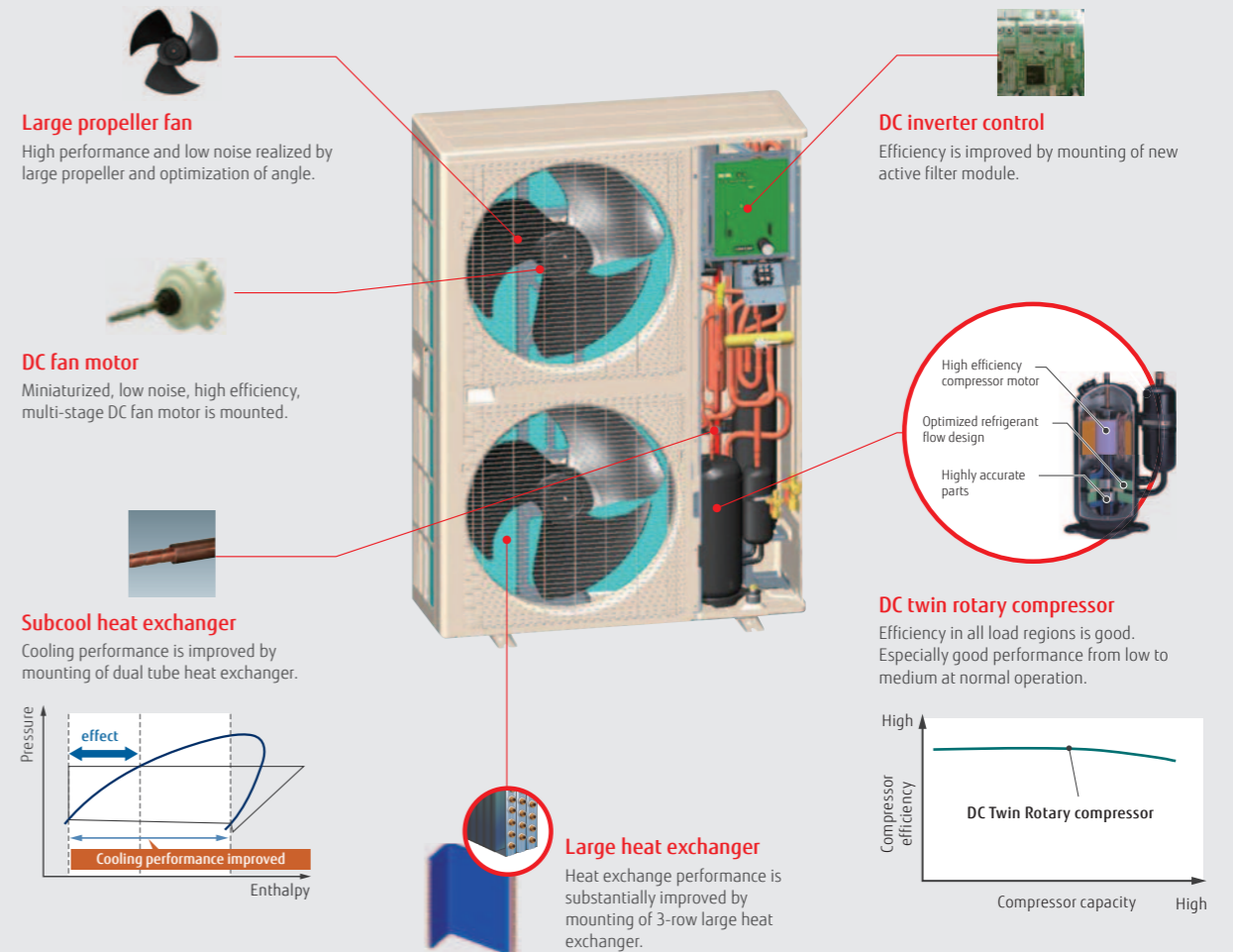

Long Piping Length

Our advanced refrigerant control technology allows us to achieve a total refrigerant piping length of 180 m. This opens up new possibilities in system design.

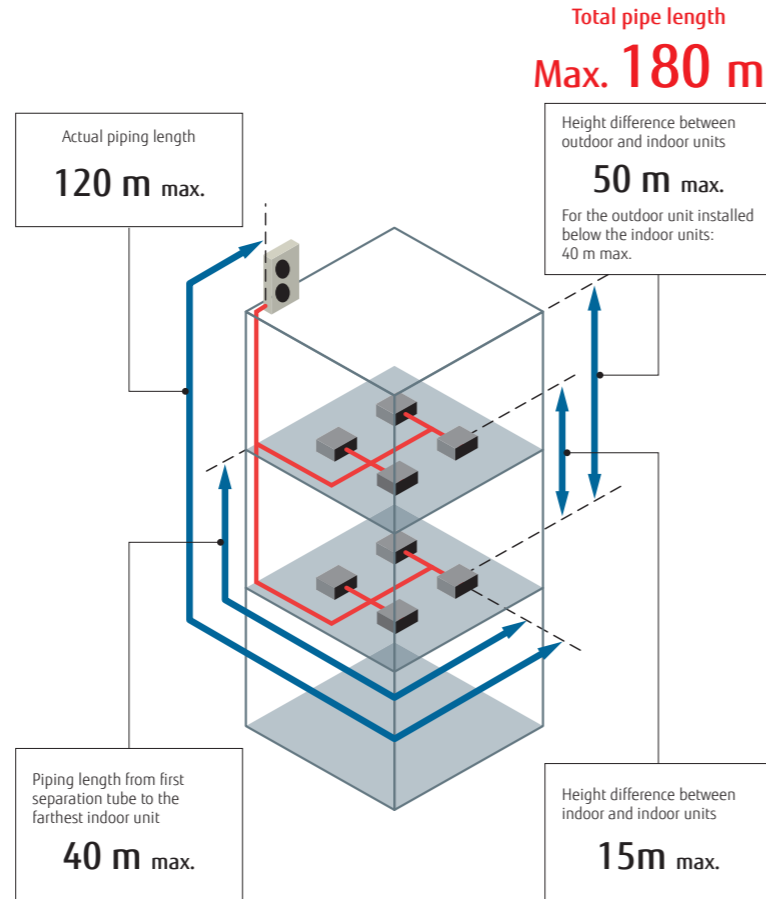

4,5,6HP : AJY040LBLAH / AJY045LBLAH / AJY054LBLAH **NEW**
AJY040LELAH [3phase] / AJY045LELAH [3phase] / AJY054LELAH [3phase]



Specifications

Rating Capacity range		HP	4	5	6	4	5	6
Model name			AJY040LBLAH	AJY045LBLAH	AJY054LBLAH	AJY040LELAH	AJY045LELAH	AJY054LELAH
Maximum Connectable Indoor Unit			1-9	1-10	1-13	1-9	1-10	1-13
Power source			Single-phase, ~230V, 50Hz			3-phase, ~400V, 50Hz		
Capacity	Cooling	kW	12.1	14.0	15.5	12.1	14.0	15.5
	Heating	kW	13.6	16.0	18.0	13.6	16.0	18.0
Input power	Cooling	kW	2.90	3.57	4.18	2.79	3.46	3.99
	Heating	kW	2.80	3.55	4.26	2.71	3.40	4.08
EER	Cooling	W/W	4.17	3.92	3.71	4.33	4.05	3.88
	Heating	W/W	4.86	4.51	4.23	5.01	4.70	4.41
COP	Cooling	W/W	4.86	4.51	4.23	5.01	4.70	4.41
	Heating	W/W	4.86	4.51	4.23	5.01	4.70	4.41
Air flow late		m ³ /h	6,200	6,400	6,900	6,200	6,400	6,900
Sound pressure level	Cooling	dB(A)	50	51	53	50	51	53
	Heating	dB(A)	52	53	55	52	53	55
Heat exchanger fin			Blue fin	Blue fin	Blue fin	Blue fin	Blue fin	Blue fin
Net Dimensions	Height	mm	1,334	1,334	1,334	1,334	1,334	1,334
	Width	mm	970	970	970	970	970	970
	Depth	mm	370	370	370	370	370	370
Weight		kg	117	117	119	119	119	119
	Type (Global Warming Potential)		R410A (2,088)	R410A (2,088)	R410A (2,088)	R410A (2,088)	R410A (2,088)	R410A (2,088)
Refrigerant	Charge	kg	4.8	5.3	5.3	4.8	5.3	5.3
	Liquid	mm	9.52	9.52	9.52	9.52	9.52	9.52
Connection pipe diameter	Gas	mm	15.88	15.88	19.05	15.88	15.88	19.05
		mm	180	180	180	180	180	180
Total pipe length		m	180	180	180	180	180	180
Max. height difference			50/40 (Outdoor unit: Upper/Lower)			50/40 (Outdoor unit: Upper/Lower)		
Operation range	Cooling	°C	-5 to 46	-5 to 46	-5 to 46	-5 to 46	-5 to 46	-5 to 46
	Heating	°C	-20 to 21	-20 to 21	-20 to 21	-20 to 21	-20 to 21	-20 to 21

Note: Specifications are based on the following conditions.

Cooling: Indoor temperature of 27°CDB/19°CWB, and outdoor temperature of 35°CDB/24°CWB.

Heating: Indoor temperature of 20°CDB/15°CWB, and outdoor temperature of 7°CDB/6°CWB.

Pipe length: 7.5 m; Height difference between outdoor unit and indoor unit: 0 m.

The protective function may work when using it outside the operation range.

Non-stop oil recovery operation

A comfortable room condition is maintained during oil recovery mode because the product continues to operate without stopping the cooling or heating operation.

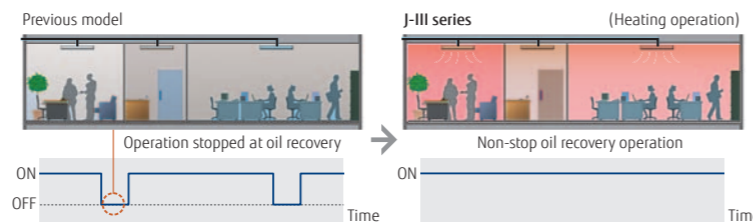

Easier Installation

Connection check function : Possible to confirm whether wiring connection and address setting are correct by a quick check run function.

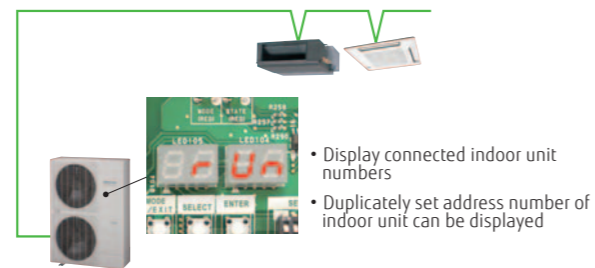

Dimensions

(Unit : mm)

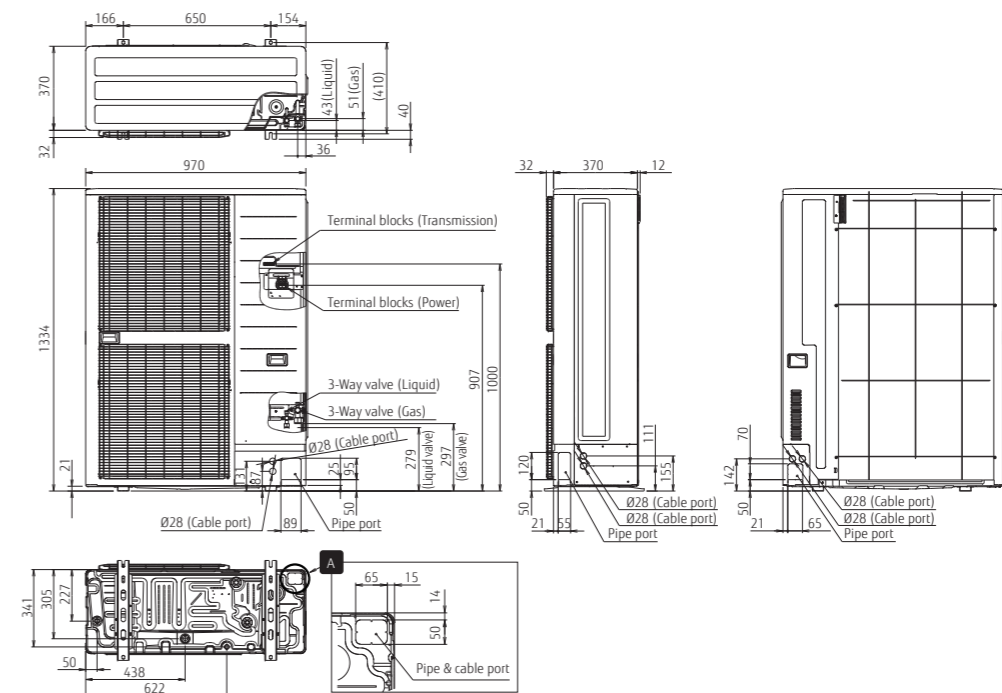

Heat Pump for Small Capacity Type

AIRSTAGE™ J-IIS

Fujitsu General provides air conditioning systems for a wide range of applications from small office buildings and stores to large houses.



System Outline

Space saving and low sound level design

Economical individual air conditioning is realized by ALL-DC technology, large capacity DC twin rotary compressor, and 3-row heat exchanger though the size is compact.

Flexible systems for homes, shops, small-size buildings air conditioning

Due to compact size design and flexible piping design, J-IIS series can be installed easily at the place where the installation space is limited such as homes, shops, and small offices. Multiple indoor units of various capacities and types can be connected.



Features

Small and light weight outdoor unit

This model is much more compact than conventional 6HP comparable outdoor units. Even when installed on the balcony it fits within the height of the fence. The compact size with a height of less than 1 m allows it to be installed under windows and in tight spaces

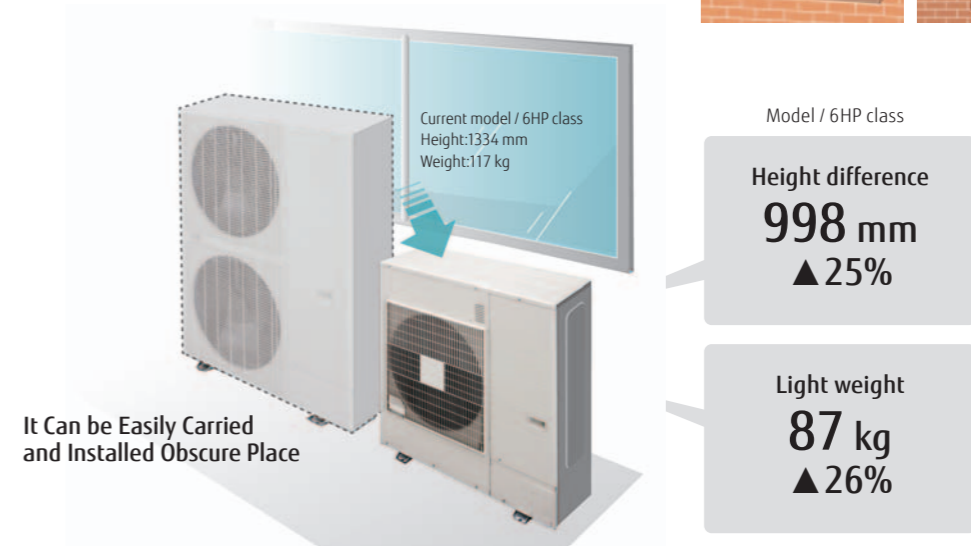
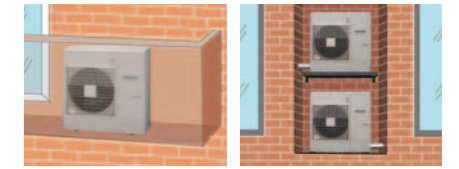

Advanced high efficiency technology

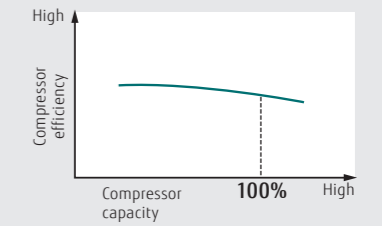
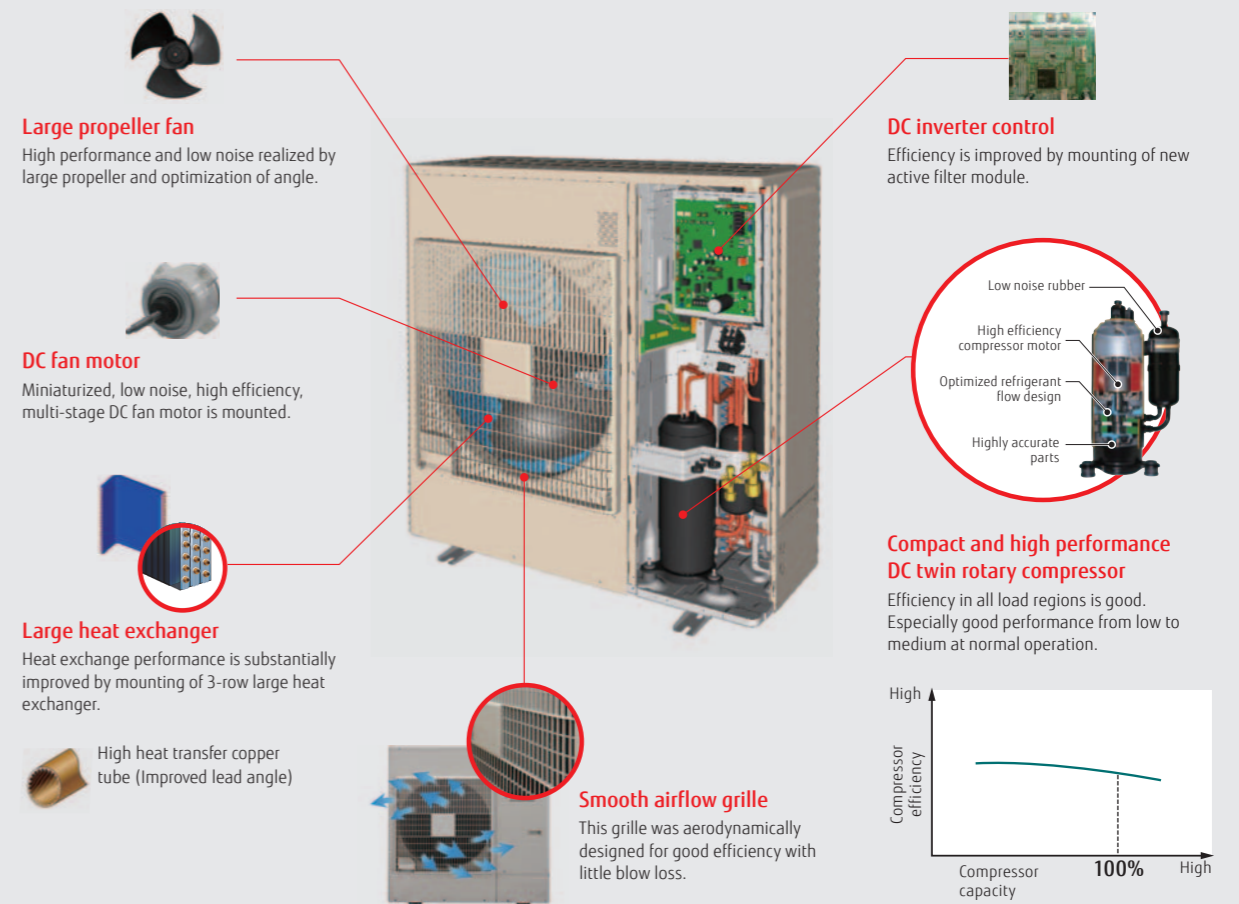

Features

Long piping length

Our advanced refrigerant control technology allows us to achieve a total refrigerant piping length of 80 m. This opens up new possibilities in system design.

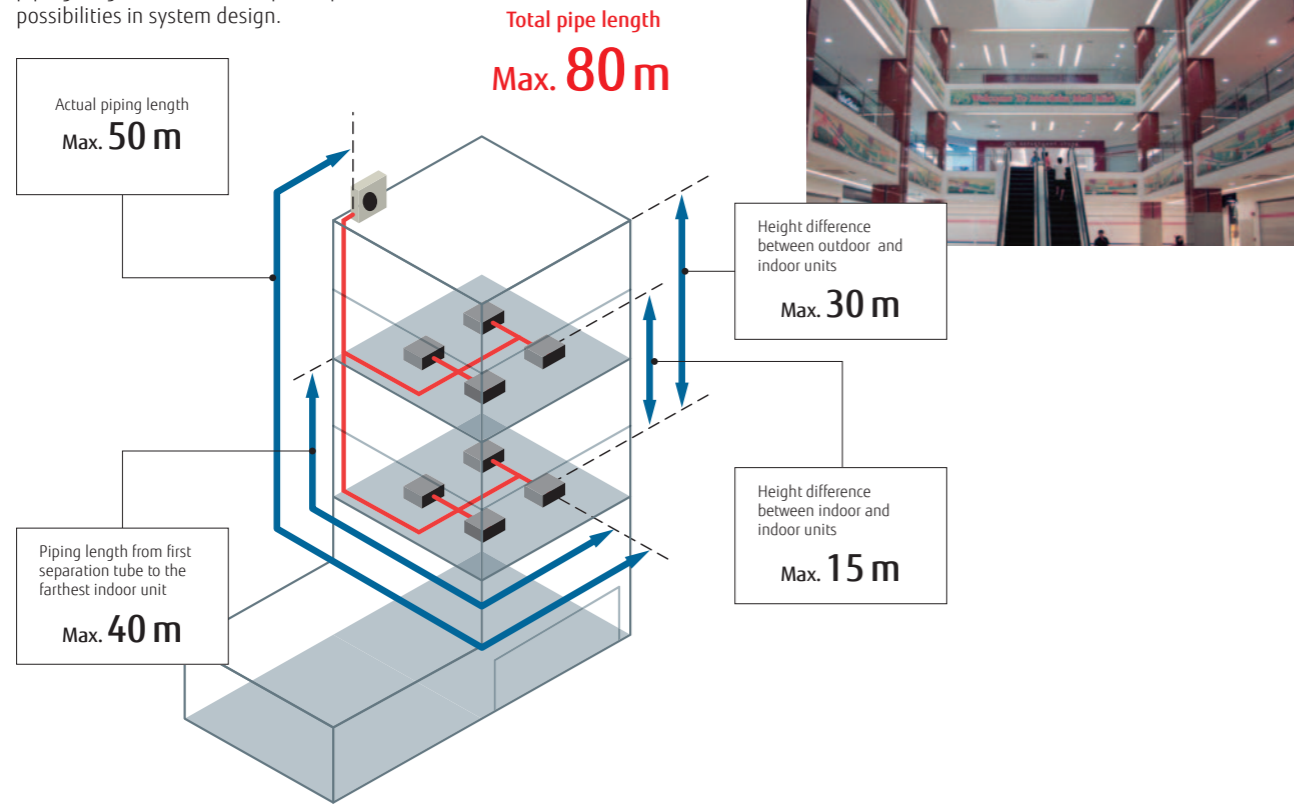

4,5,6HP : AJY040LCLAH / AJY045LCLAH / AJY054LCLAH

AIRSTAGE™ J-IIS



Specifications

Rating Capacity range	HP	4	5	6
Model name		AJY040LCLAH	AJY045LCLAH	AJY054LCLAH
Maximum Connectable Indoor Unit		7	8	8
Power source		Single-phase, ~230V, 50Hz		
Capacity	Cooling	12.1	14.0	15.1
	Heating	13.6	16.0	16.5
Input power	Cooling	3.44	4.43	5.32
	Heating	3.09	3.93	4.26
EER	Cooling	3.52	3.16	2.84
COP	Heating	4.40	4.07	3.87
Air flow rate		4,040	4,200	4,200
Sound pressure level	Cooling	51	53	54
	Heating	54	55	56
Heat exchanger fin		Blue fin	Blue fin	Blue fin
Net Dimensions	Height	998	998	998
	Width	970	970	970
	Depth	370	370	370
Weight		86	86	87
	Type (Global Warming Potential)	R410A (2,088)	R410A (2,088)	R410A (2,088)
Refrigerant	Charge	4.0	4.0	4.0
	Liquid	9.52	9.52	9.52
Connection pipe diameter	Gas	15.88	15.88	15.88
Total pipe length		80	80	80
Max. height difference		30	30	30
Operation range	Cooling	-5 to 46	-5 to 46	-5 to 46
	Heating	-20 to 21	-20 to 21	-20 to 21

Note : Specifications are based on the following conditions.

Cooling : Indoor temperature of 27°CDB / 19°CWB, and outdoor temperature of 35°CDB / 24°CWB.

Heating : Indoor temperature of 20°CDB / (15°CWB), and outdoor temperature of 7°CDB / 6°CWB.

Pipe length : 7.5 m; Height difference between outdoor unit and indoor unit : 0 m.

The protective function may work when using it outside the operation range.

Non-stop oil recovery operation

A comfortable room condition is maintained during oil recovery mode because the product continues to operate without stopping the cooling or heating operation.

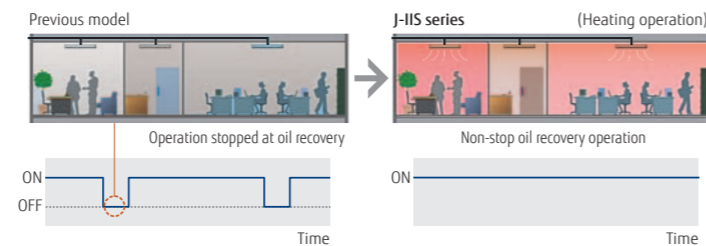

Easier Installation

Connection check function : Possible to confirm whether wiring connection and address setting are correct by a quick check run function.

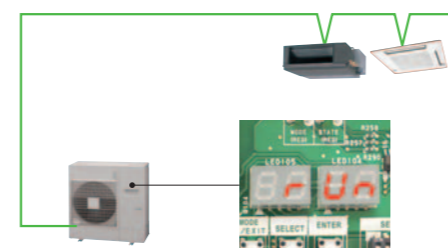

- Display connected indoor unit numbers
- Duplicately set address number of indoor unit can be displayed

Dimensions

(Unit : mm)

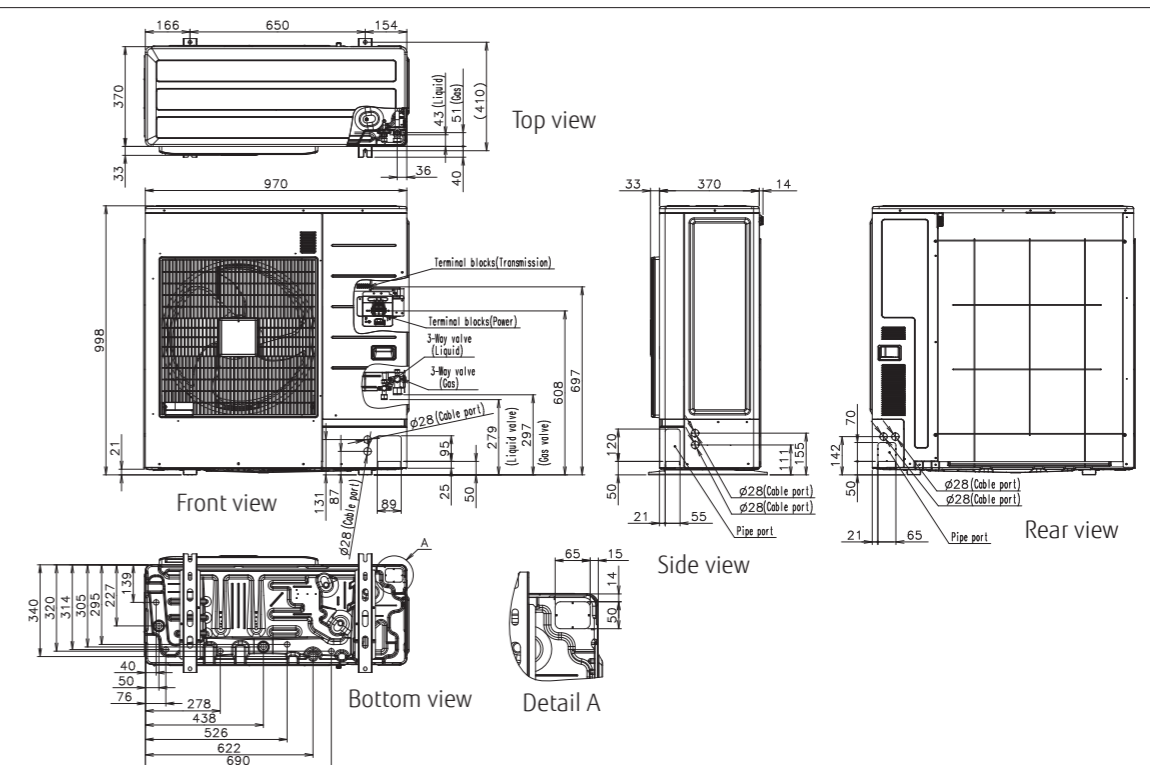

Indoor units

Indoor Unit Lineup

12 Types, 66 Models, Capacity range from 1.1 kW to 28.0 kW

Capacity range (kW)		1.1	2.2	2.8	3.6	4.5	5.6	7.1	9.0	10.0	11.2	12.5	14.0	18.0	22.4	25.0	28.0		
Model code		4	7	9	12	14	18	24	30	34	36	45	54	60	72	90	96		
Cassette	4-way Compact Cassette																		
	4-way Cassette	<small>Slim type</small>																	
		<small>Large type</small>																	
NEW	Mini Duct (With drain pump)																		
	Slim Duct (With drain pump)																		
	Medium Static Pressure Duct																		
	High Static Pressure Duct																		
	Large Airflow Duct																		
Floor	Floor (*Same as Ceiling models)																		
	Slim Concealed Floor (*Same as Slim Duct models)																		
Ceiling	Ceiling																		
Wall Mounted	Wall Mounted																		
	Wall Mounted (EEV external)																		

With this model, connection of EV kit is necessary.

*1: ARXC60/72/90G/96G cannot be connected to J-IIS and J-III series.
*2: Large Airflow Duct can be connected to V-III series only.

Indoor Units Specifications

4-way Compact Cassette



Model name			AUXB04GALH	AUXB07GALH	AUXB09GALH	AUXB12GALH	AUXB14GALH	AUXB18GALH	AUXB24GALH	
Power source			Single-phase, ~230V, 50Hz							
Capacity	Cooling	kW	1.1	2.2	2.8	3.6	4.5	5.6	7.1	
	Heating		1.3	2.8	3.2	4.1	5.0	6.3	8.0	
Input power			23	25	25	29	35	36	84	
Airflow rate	High	m³/h	530	540	550	600	680	710	1,030	
	Med		420/450*1	450	450	530	590	580	830	
	Low		300/350*1	350	350	390	390	400	450	
Sound pressure level	High	dB(A)	34	34	35	37	38	41	50	
	Med		28/30*1	30	30	34	34	35	44	
	Low		21/25*1	25	25	27	27	27	30	
Net Dimensions (H × W × D)			mm 245 × 570 × 570							
Weight			kg(lbs) 15 (33)						17 (37)	
Connection pipe diameter	Liquid (Flare)	mm	6.35						9.52	
	Gas (Flare)		12.70						15.88	
Drain hose diameter (I.D./O.D.)			25/32							
Cassette Grille			Model name UTG-UFYC-W							
Net Dimensions (H×W×D)			mm 50 × 700 × 700							
Weight			kg(lbs) 2.6 (6)							

Note : Specifications are based on the following conditions. Cooling : Indoor temperature of 27°CDB / 19°CWB, and outdoor temperature of 35°CDB / 24°CWB. Heating : Indoor temperature of 20°CDB / (15°CWB), and outdoor temperature of 7°CDB / 6°CWB. Pipe length : 7.5 m; Height difference between outdoor unit and indoor unit : 0 m. Voltage : 230 [V]. *1: This value is under cooling operation.

4-way Cassette



Model name			AUXD18GALH	AUXD24GALH	AUXA18GALH	AUXA24GALH	AUXA30GALH	AUXA34GALH	AUXA36GALH	AUXA45GALH	AUXA54GALH	
Power source			Single-phase, ~230V, 50Hz									
Capacity	Cooling	kW	5.6	7.1	5.6	7.1	9.0	10.0	11.2	12.5	14.0	
	Heating		6.3	8.0	6.3	8.0	10.0	11.2	12.5	14.0	16.0	
Input power			39	46	51	51	59	77	80	99	119	
Airflow rate	High	m³/h	1,150	1,280	1,420	1,420	1,600	1,750	1,800	1,900	2,000	
	Med		940	1,040	1,230	1,230	1,300	1,300	1,300	1,370	1,370	
	Low		870	870	1,100/1,000*1	1,100/1,000*1	1,100	1,100	1,100	1,100	1,100	1,100
Sound pressure level	High	dB(A)	36	38	40	40	40	43	44	46	47	
	Med		30	33	36	36	38	38	38	39	39	
	Low		29	29	33/31*1	33/31*1	33	33	33	33	33	
Net Dimensions (H × W × D)			mm 246 × 840 × 840		288 × 840 × 840							
Weight			kg(lbs) 22 (48)		27 (59)							
Connection pipe diameter	Liquid (Flare)	mm			9.52							
	Gas (Flare)				15.88						19.05	
Drain hose diameter (I.D./O.D.)					25/32							
Cassette Grille			Model name UTG-UGYA-W									
Net Dimensions (H×W×D)			mm 50 × 950 × 950									
Weight			kg(lbs) 5.5 (12)									

Note : Specifications are based on the following conditions. Cooling : Indoor temperature of 27°CDB / 19°CWB, and outdoor temperature of 35°CDB / 24°CWB. Heating : Indoor temperature of 20°CDB / (15°CWB), and outdoor temperature of 7°CDB / 6°CWB. Pipe length : 7.5 m; Height difference between outdoor unit and indoor unit : 0 m. Voltage : 230 [V]. *1: This value is "cooling operation / heating operation".

Mini Duct



Model name			ARXK07GCLH	ARXK09GCLH	ARXK12GCLH	ARXK14GCLH	ARXK18GCLH	ARXK24GCLH	
Power source			Single-phase, ~230V, 50Hz						
Capacity	Cooling	kW	2.2	2.8	3.6	4.5	5.6	7.1	
	Heating		2.8	3.2	4.0	5.0	6.3	8.0	
Input power			28	28	35	66	73	80	
Airflow rate	High	m³/h	460	460	550	760	930	1,160	
	Med		420	420	480	560	740	960	
	Low		370	370	410	410	540	750	
Static pressure range			0 to 30	0 to 30	0 to 30	0 to 50	0 to 50	0 to 50	
Standard static pressure			10	10	10	15	15	15	
Sound pressure level	High	dB(A)	26	26	29	34	33	32	
	Me-Hi		25	25	27	31	30	30	
	Med		24	24	26	28	28	28	
	Lo-Hi		23	23	25	26	26	27	
	Low		22	22	24	24	24	25	
Quiet		21	21	22	22	22	22		
Net Dimensions (H × W × D)			mm 198 × 700 × 450				198 × 900 × 450	198 × 1,100 × 450	
Weight			kg(lbs) 15.5 (34)		16 (35)		19 (42)	22.5 (50)	
Connection pipe diameter	Liquid (Flare)	mm	6.35						9.52
	Gas (Flare)		12.70						15.88
Drain hose diameter (I.D./O.D.)			25/32						

Note : Specifications are based on the following conditions. Cooling : Indoor temperature of 27°CDB / 19°CWB, and outdoor temperature of 35°CDB / 24°CWB. Heating : Indoor temperature of 20°CDB / (15°CWB), and outdoor temperature of 7°CDB / 6°CWB. Pipe length : 7.5 m; Height difference between outdoor unit and indoor unit : 0 m. Voltage : 230 [V].

Slim Duct / Slim Concealed Floor



Model name			ARXD04GALH	ARXD07GALH	ARXD09GALH	ARXD12GALH	ARXD14GALH	ARXD18GALH	ARXD24GALH	
Power source			Single-phase, ~230V, 50Hz							
Capacity	Cooling	kW	1.1	2.2	2.8	3.6	4.5	5.6	7.1	
	Heating		1.3	2.8	3.2	4.0	5.0	6.3	8.0	
Input power			40	44	50	54	92	83	122	
Airflow rate	High	m³/h	510	550	600	600	800	940	1,330	
	Med		400/470*1	490	550	510	710	840	1,240	
	Low		320/440*1	440	480	450	610	750	1,100	
Static pressure range			0 to 90	0 to 90	0 to 90	0 to 90	0 to 90	0 to 90	0 to 50	
Standard static pressure			25	25	25	25	25	25	25	
Sound pressure level	High	dB(A)	26	28	29	30	34	34	35	
	Med		21/25*1	25	26	27	32	32	32	
	Low		20/22*1	22	24	24	28	28	29	
Net Dimensions (H × W × D)			mm 198 × 700 × 620							
Weight			kg(lbs) 17 (37)						18 (40)	198 × 900 × 620 198 × 1,100 × 620 26 (57)
Connection pipe diameter	Liquid (Flare)	mm	6.35						9.52	
	Gas (Flare)		12.70						15.88	
Drain hose diameter (I.D./O.D.)			25/32							

Note : Specifications are based on the following conditions. Cooling : Indoor temperature of 27°CDB / 19°CWB, and outdoor temperature of 35°CDB / 24°CWB. Heating : Indoor temperature of 20°CDB / (15°CWB), and outdoor temperature of 7°CDB / 6°CWB. Pipe length : 7.5 m; Height difference between outdoor unit and indoor unit : 0 m. Voltage : 230 [V]. *1: This value is under cooling operation.

Medium Static Pressure Duct



Model name			ARXA24GBLH	ARXA30GBLH	ARXA36GBLH	ARXA45GBLH	
Power source			Single-phase, ~230V, 50Hz				
Capacity	Cooling	kW	7.1	9.0	11.2	12.5	
	Heating		8.0	10.0	12.5	14.0	
Input power			94	108	194	240	
Airflow rate	High	m³/h	1,280	1,410	1,840	1,970	
	Med		990	1,280	1,600	1,860	
	Low		840	1,150	1,470	1,640	
Static pressure range			0 to 150	0 to 150	0 to 150	0 to 150	
Standard static pressure			40	50	50	60	
Sound pressure level	High	dB(A)	31	34	37	41	
	Med		27	32	35	38	
	Low		23	29	33	36	
Net Dimensions (H × W × D)			mm 270 × 1,135 × 700				
Weight			kg(lbs) 36 (79)				40 (88)
Connection pipe diameter	Liquid (Flare)	mm					9.52
	Gas (Flare)		15.88				19.05
Drain hose diameter (I.D./O.D.)			25/32				

Note : Specifications are based on the following conditions. Cooling : Indoor temperature of 27°CDB / 19°CWB, and outdoor temperature of 35°CDB / 24°CWB. Heating : Indoor temperature of 20°CDB / (15°CWB), and outdoor temperature of 7°CDB / 6°CWB. Pipe length : 7.5 m; Height difference between outdoor unit and indoor unit : 0 m. Voltage : 230 [V].

High Static Pressure Duct



Model name			ARXC36GBTH	ARXC45GATH	ARXC60GATH*	ARXC72GBTH*	ARXC90GBTH*	ARXC96GATH*
Power source			Single-phase, ~230V, 50Hz					
Capacity	Cooling	kW	11.2	12.5	18.0	22.4	25.0	28.0
	Heating		12.5	14.0	20.0	25.0	28.0	31.5
Input power			207	715	730	681	819	838
Airflow rate	High	m³/h	1,990	3,500	3,500	3,900	4,300	4,850
	Med		1,680	3,000	3,000	3,300	4,000	4,250
	Low		1,330	2,460	2,460	3,000	3,500	3,600
Static pressure range			0 to 200	100 to 250	100 to 250	0 to 300	0 to 300	0 to 300
Standard static pressure			100	100	100	150	150	150
Sound pressure level	High	dB(A)	42	49	49	47	48	48
	Med		36	45	45	43	46	45
	Low		32	42	42	40	44	42
Net Dimensions (H × W × D)			mm 400 × 1,050 × 500		450 × 1,587 × 700			550 × 1,587 × 700
Weight			kg(lbs) 40 (88)		46 (101)		84 (185)	105 (231)
Connection pipe diameter	Liquid	mm	9.52 (Flare)					
	Gas		19.05 (Flare)					
Drain hose diameter (I.D./O.D.)			25/32					

Note : Specifications are based on the following conditions. Cooling : Indoor temperature of 27°CDB / 19°CWB, and outdoor temperature of 35°CDB / 24°CWB. Heating : Indoor temperature of 20°CDB / (15°CWB), and outdoor temperature of 7°CDB / 6°CWB. Pipe length : 7.5 m; Height difference between outdoor unit and indoor unit : 0 m. Voltage : 230 [V]. * ARXC60/72/90/96G cannot be connected to J-IIS and J-III series.

Indoor Units Specifications

Large Airflow Duct



Model name		ARXN18GATH	ARXN24GATH	ARXN30GATH	ARXN34GATH	ARXN36GATH	ARXN45GATH
Power source		Single-phase, ~230V, 50Hz					
Capacity	Cooling	5.6	7.1	9.0	10.0	11.2	12.5
	Heating	6.3	8.0	10.0	11.2	12.5	14.0
Input power		154	205	306	432	572	572
Airflow rate	High	2,280	2,640	3,200	3,720	4,120	4,120
	Med	—	—	—	—	—	—
	Low	—	—	—	—	—	—
Static pressure range		50 to 100	50 to 150	50 to 250	50 to 250	50 to 300	50 to 300
Standard static pressure		50	50	50	50	60	60
Sound pressure level	High	35	37	40	43	45	45
	Med	—	—	—	—	—	—
	Low	—	—	—	—	—	—
Net Dimensions (H × W × D)		450 × 1,587 × 700					
Weight		84 (185)					
Connection pipe diameter	Liquid (Flare)	15.88 (Flare)		9.52 (Flare)		19.05 (Flare)	
	Gas (Flare)	—		—		—	
Drain hose diameter (I.D./O.D.)		25/32					

Note : Specifications are based on the following conditions.
Large Airflow Duct can be connected to V-III series only.

Cooling : Indoor temperature of 27°CDB / 19°CWB, and outdoor temperature of 35°CDB / 24°CWB.
Heating : Indoor temperature of 20°CDB / (15°CWB), and outdoor temperature of 7°CDB / 6°CWB.
Pipe length : 7.5 m; Height difference between outdoor unit and indoor unit : 0 m.
Voltage : 230 [V].

Floor / Ceiling



Model name		ABYA12GATH	ABYA14GATH	ABYA18GATH	ABYA24GATH
Power source		Single-phase, ~230V, 50Hz			
Capacity	Cooling	3.6	4.5	5.6	7.1
	Heating	4.0	5.0	6.3	8.0
Input power		30	42	74	99
Airflow rate	High	660	780	1,000	1,000
	Med	570	640	720	820
	Low	490	550	580	680
Sound pressure level	High	36	40	46	47
	Med	32	36	39	42
	Low	28	34	35	37
Net Dimensions (H × W × D)		199 × 990 × 655			
Weight		25 (55)	26 (57)	26 (57)	27 (59)
Connection pipe diameter	Liquid (Flare)	6.35		9.52	
	Gas (Flare)	12.70		15.88	
Drain hose diameter (I.D./O.D.)		25/32			

Note : Specifications are based on the following conditions.

Cooling : Indoor temperature of 27°CDB / 19°CWB, and outdoor temperature of 35°CDB / 24°CWB.
Heating : Indoor temperature of 20°CDB / (15°CWB), and outdoor temperature of 7°CDB / 6°CWB.
Pipe length : 7.5 m; Height difference between outdoor unit and indoor unit : 0 m.
Voltage : 230 [V].

Ceiling



Model name		ABYA30GATH	ABYA36GATH	ABYA45GATH	ABYA54GATH
Power source		Single-phase, ~230V, 50Hz			
Capacity	Cooling	9.0	11.2	12.5	14.0
	Heating	10.0	12.5	14.0	16.0
Input power		66	85	131	180
Airflow rate	High	1,630	1,690	2,010	2,270
	Med	1,370	1,400	1,600	1,780
	Low	1,140	1,170	1,230	1,280
Sound pressure level	High	42	45	48	51
	Med	38	38	42	45
	Low	33	34	35	36
Net Dimensions (H × W × D)		240 × 1,660 × 700			
Weight		46 (101)	48 (106)		
Connection pipe diameter	Liquid (Flare)	9.52		9.52	
	Gas (Flare)	15.88		19.05	
Drain hose diameter (I.D./O.D.)		25/32			

Note : Specifications are based on the following conditions.

Cooling : Indoor temperature of 27°CDB / 19°CWB, and outdoor temperature of 35°CDB / 24°CWB.
Heating : Indoor temperature of 20°CDB / (15°CWB), and outdoor temperature of 7°CDB / 6°CWB.
Pipe length : 7.5 m; Height difference between outdoor unit and indoor unit : 0 m.
Voltage : 230 [V].

Wall Mounted



Model name		ASYA04GACH	ASYA07GACH	ASYA09GACH	ASYA12GACH	ASYA14GACH	ASYE04GACH	ASYE07GACH	ASYE09GACH	ASYE12GACH	ASYE14GACH
Power source		Single-phase, ~230V, 50Hz									
Capacity	Cooling	1.1	2.2	2.8	3.6	4.5	1.1	2.2	2.8	3.6	4.5
	Heating	1.3	2.8	3.2	4.1	5.0	1.3	2.8	3.2	4.1	5.0
Input power		13	17	18	22	34	12	15	16	21	34
Airflow rate	High	450	490	500	560	670	450	490	500	560	680
	Med	370/440*1	450	450	480	490	370/440*1	450	450	480	490
	Low	320/420*1	370/420*1	370/420*1	420	420	300/420*1	370/420*1	370/420*1	420	420
Sound pressure level	High	33	35	36	39	44	32	34	35	38	43
	Med	27/32*1	33	33	35	37	26/31*1	32	32	34	35
	Low	22/31*1	27/31*1	27/31*1	31	32	19/30*1	26/30*1	26/30*1	30	30
Net Dimensions (H × W × D)		275 × 790 × 215					275 × 790 × 215				
Weight		9 (20)					9 (20)				
Connection pipe diameter	Liquid (Flare)	6.35					6.35				
	Gas (Flare)	12.70					12.70				
Drain hose diameter (I.D./O.D.)		13.8/15.8 to 16.7					13.8/15.8 to 16.7				
EV Kit (option)		-					UTR-EV09XB		UTR-EV14XB		

Note : Specifications are based on the following conditions.

Cooling : Indoor temperature of 27°CDB / 19°CWB, and outdoor temperature of 35°CDB / 24°CWB.
Heating : Indoor temperature of 20°CDB / (15°CWB), and outdoor temperature of 7°CDB / 6°CWB.
Pipe length : 7.5 m; Height difference between outdoor unit and indoor unit : 0 m.
Voltage : 230 [V].
*1 : This value is under cooling operation.

Wall Mounted



Model name		ASYA18GACH	ASYA24GACH	ASYA30GACH
Power source		Single-phase, ~230V, 50Hz		
Capacity	Cooling	5.6	7.1	8.0
	Heating	6.3	8.0	9.0
Input power		32	60	91
Airflow rate	High	840	1,100	1,240
	Med	770	910	980
	Low	690	730	770
Sound pressure level	High	41	48	52
	Med	39	43	45
	Low	35	35	35
Net Dimensions (H × W × D)		320 × 998 × 228		
Weight		15 (33)		
Connection pipe diameter	Liquid (Flare)	9.52		
	Gas (Flare)	15.88		
Drain hose diameter (I.D./O.D.)		12/16		

Note : Specifications are based on the following conditions.

Cooling : Indoor temperature of 27°CDB / 19°CWB, and outdoor temperature of 35°CDB / 24°CWB.
Heating : Indoor temperature of 20°CDB / (15°CWB), and outdoor temperature of 7°CDB / 6°CWB.
Pipe length : 7.5 m; Height difference between outdoor unit and indoor unit : 0 m.
Voltage : 230 [V].

Controller

Control system overview

User's needs are supported by offering a variety of controls, such as individual control, central control and building management control options.

Air Conditioning Individual Control

- Wired Remote Controller (Touch panel)**
UTY-RNRYZ1 **NEW**
- Wired Remote Controller**
UTY-RLRY
- Simple Remote Controller**
UTY-RSKY
- Simple Remote Controller**
UTY-RHKY
Without operation mode
- Wireless Remote Controller**
UTY-LNHY



For All AIRSTAGE™ series

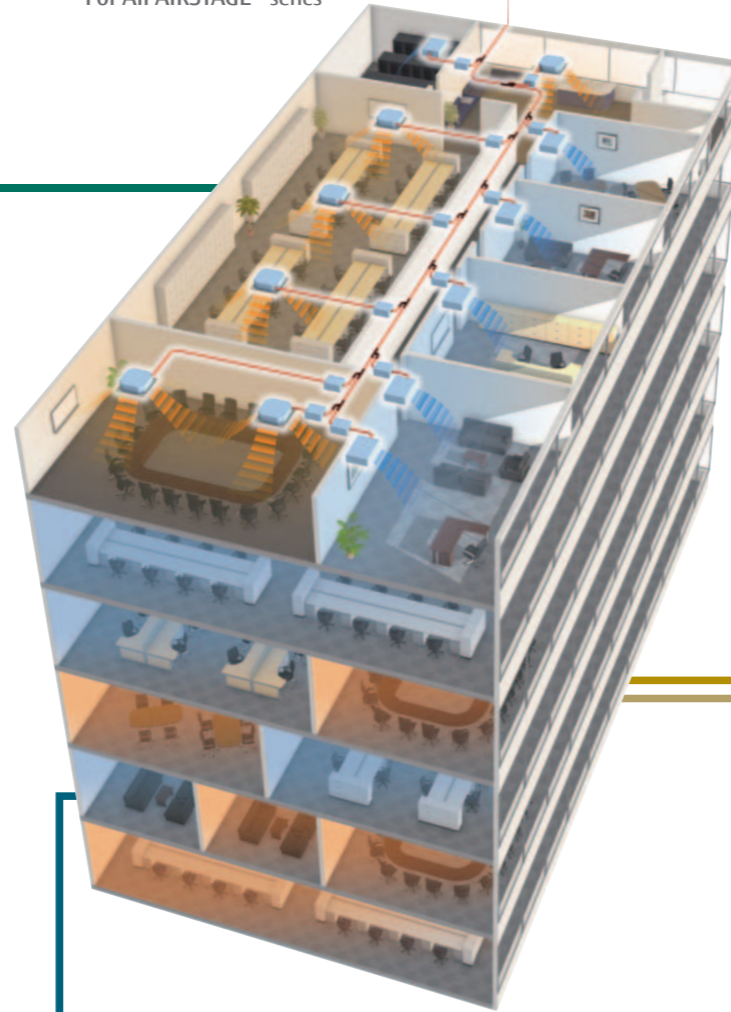

Air Conditioning Centralized Control

- System Controller** (Software)
UTY-APGX
UTY-ALGX (Lite edition)
Internet or Public Telephone Line
USB Adaptor *2 (Locally purchased)
- Touch Panel Controller**
UTY-DTGYZ1 **NEW**
- Central Remote Controller**
UTY-DCGY
- Group Remote Controller**
UTY-CGGY
Network Converter UTY-VGGXZ1

Converter / Adaptor (for external device)

- BACnet® Gateway** (Software)
UTY-ABGX
USB Adaptor *2 (Locally purchased)
- Network Converter (BMS/LONWORKS®)**
UTY-VLGX
- MODBUS® Converter**
UTY-VMGX **NEW**
- MODBUS® Interface**
FJ-RC-MBS-1
- KNX® Interface**
FJ-RC-KNX-1i
- Wireless LAN Interface**
FJ-RC-WIFI-1
- External Switch Controller**
UTY-TEKX

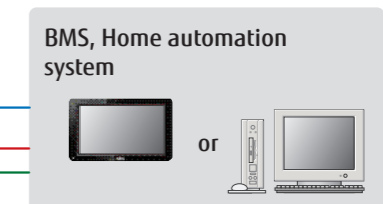
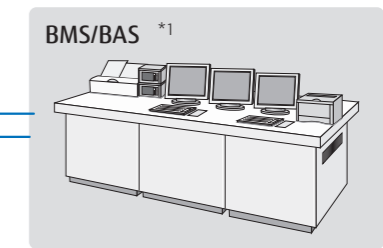

*1. BMS/BAS: Building Management System/Building Automation System
*2. USB Adaptor: Echelon™ U10 USB Network Interface

Converter / Adaptor (for system expansion)

- Network Converter for single split**
UTY-VTGX **NEW**
- Network Converter (AC power supply)**
UTY-VTGXV **NEW**
- Network Converter for Group Remote Controller**
UTY-VGGXZ1
- Signal Amplifier**
UTY-VSGXZ1

Service & Maintenance Tool

- Web Monitoring System** (Software)
UTY-AMGX
Monitoring Side
VRF Network System Side
Outdoor unit
Transmission line
Web Monitoring Tool
Indoor unit
USB adapter (Locally purchased)
Internet or Public Telephone Line
- Service Tool** (Software)
UTY-ASGX
USB Adaptor *2 (Locally purchased)

NEW

Wired Remote Controller (Touch Panel)

Comparison table of Controllers

Item	Wired Remote Controller (Touch panel)	Wired Remote Controller	Simple Remote Controller	Simple Remote Controller*1	Wireless Remote Controller	Group Remote Controller	Central Remote Controller	Touch Panel Controller	System Controller Lite (Software)	System Controller (Software)
Model name	UTY-RNRYZ1	UTY-RLRY	UTY-RSKY	UTY-RHKY	UTY-LNHY	UTY-CGGY	UTY-DCGY	UTY-DTGYZ1	UTY-ALGX	UTY-APGX
Max. controllable remote controller groups	1	1	1	1	1	8	100	400	400	1600
Max. controllable indoor units	16	16	16	16	16	128	100	400	400	1600
Max. controllable groups	-	-	-	-	-	-	16	400	400	1600
On / Off	●	●	●	●	●	●	●	●	●	●
Operation mode setting	●	●	●	●	●	●	●	●	●	●
Fan speed setting	●	●	●	●	●	●	●	●	●	●
Room temp. setting	●	●	●	●	●	●	●	●	●	●
Room temp. set point limitation	●	●	-	-	-	-	●	●	●	●
Test operation	●	●	●	-	●	-	●	●	-	-
Up/down air direction flap setting	●	●	-	-	●	-	●	●	●	●
Right/left air direction flap setting	●	●	-	-	●	-	●	●	●	●
Group setting	-	-	-	-	-	-	●	●	●	●
RC prohibition	-	-	-	-	-	-	●	●	●	●
Anti freeze setting	●	-	-	-	-	-	●	●	●	●
Economy mode setting	●	●	-	-	●	-	●	●	●	●
Error	●	●	●	●	-	●	●	●	●	●
Defrosting	●	●	●	●	-	-	●	●	●	●
Current time	●	●	-	-	●	●	●	●	●	●
Day of week	●	●	-	-	-	●	-	●	●	●
R.C. prohibition	●	●	●	●	-	●	●	●	●	●
Cooling/heating priority	●	●	●	●	-	●	●	●	●	●
Address display	●	●	●	●	-	●	●	●	●	●
Room temp	●	-	-	-	-	-	-	-	-	-
Multi language	●	-	-	-	-	-	●	●	●	●
Summer time	●	-	-	-	-	-	●	●	●	●
Name registration	●	-	-	-	-	-	●	●	●	●
Backlight	●	-	●	●	-	-	●	●	-	-
2D floor layout / 3D building display	-	-	-	-	-	-	-	-	-	●
Schedule timer	Period	Week	Week	-	-	Week	Week	Year	Year	Year
	On/off, Temp, Mode, Times per day	8	4	-	-	4	20	20	144	144
On/off timer	●	●	-	-	●	-	-	-	-	-
Sleep timer	-	-	-	-	●	-	-	-	-	-
Program timer	-	-	-	-	●	-	-	-	-	-
Auto off timer	●	●	-	-	-	-	-	-	-	-
Day off	●	●	-	-	-	-	●	●	●	●
Min. unit of timer setting (Minutes)	10 • 30	30	-	-	5	10	10	10	10	10
Status monitoring system	-	-	-	-	-	-	●	●	●	●
Electricity charge apportionment	-	-	-	-	-	-	-	○	○	●
Error history	●	●	-	-	-	●	●	●	●	●
Emergency stop	-	-	-	-	-	-	●*2	●*2	-	-
Remote management	-	-	-	-	-	-	-	●	○	●
Energy saving management	-	-	-	-	-	-	-	-	○	○
E-mail notification for malfunction	-	-	-	-	-	-	-	●	●	●
Key lock	● Child lock	● Child lock	-	-	-	● Child lock	● Password setting	● Password setting	● Password setting	● Password setting

*1 "Operation mode" setting is not available for this model.
*2 This function is available only through external input control.

●: Supported ○: Optional function
-: Not supported yet

UTY-RNRYZ1



Max. Controllable
16 indoor units

Features

Easy operation by high-definition large STN-LCD touch panel screen

- Easy finger touch operation with LCD panel
- Built-in weekly/Daily timer(ON/OFF,Temp.,Mode)
- Backlight enables easy operation in a darkened room
- Room temperature display
- Control up to 16 indoor units
- Corresponds to 12 different languages (English, Chinese, French, German, Spanish, Russian, Polish, Italian, Greek, Portuguese, Turkish and Dutch)
- 2-wire type

High performance and compact size

In addition to the individual control, weekly timer, and various energy saving controls can be realized using one remote controller only.



Accurate and comfortable control

Indoor temperature can be detected accurately by the inclusion of a thermo sensor in the body of the wired controller.

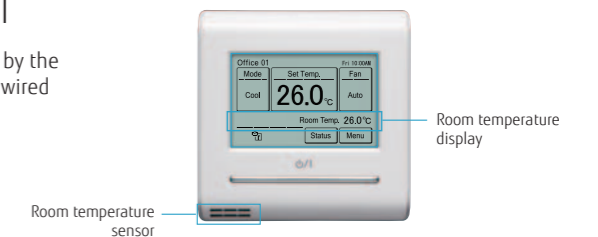

Various energy saving control

Auto OFF timer

- The indoor unit automatically is turned off when it reaches to the preset operating time frame.
- The time frame of the "Auto off timer" can be flexibly scheduled.
- Can be set off time 30 to 240 minutes

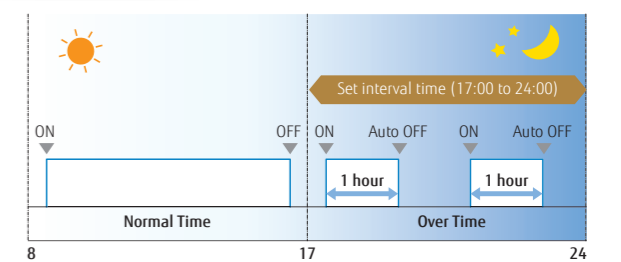

Ex.) At interval time hour (17:00 to 24:00) to prevent forgetting to turn off
Set off time : 1 hour

2 schedules Weekly Timer

Set Temperature Auto Return

Set Temperature Upper and Lower Limit Setting

Specifications

Model name	UTY-RNRYZ1
Power Source	DC 12 V
Dimensions (H × W × D) (mm)	120 × 120 × 20.4
Weight (g)	220

DC12 V is supplied by the indoor unit.

Wired Remote Controller

UTY-RLRY



Features

- Various timer setup (ON / OFF / WEEKLY) are possible.
- The room temperature can be controlled by detecting the temperature accurately with Built-in thermo sensor.
- When a failure occurs, the error code is displayed.
- Error history. (Last 16 error codes can be accessed.)
- 2-wire type

Max. Controllable
16 indoor units

High performance and compact size

In addition to the individual control, weekly timer, and various energy saving controls can be realized using only one remote controller.



High visibility and easy operation

- "Mode", "Set Temp", and "Fan" are displayed at large size on the top screen.
- Each function to be set is indicated by an icon.
- Control guide is displayed and operation is simple and straightforward.

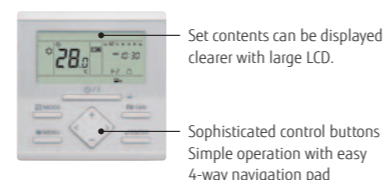

Auto-off timer

- The indoor unit automatically turns off after a set time has passed.

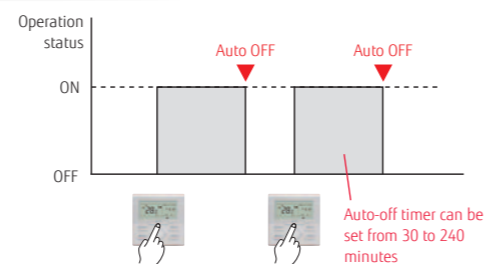

Weekly timer function

- Not only time setting On / Off, but also setting of the operation mode and set temperature can be set by Weekly timer function.

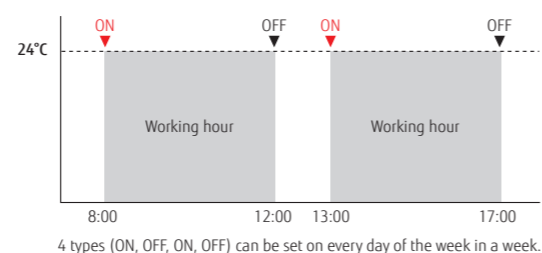

Various energy saving control

- Set Temperature Auto Return
- Set Temperature Upper and Lower Limit Setting

Specifications

Model name	UTY-RLRY
Power Source	DC 12 V
Dimensions (H × W × D) (mm)	120 × 120 × 17
Weight (g)	170

DC12 V is supplied by the indoor unit.

Simple Remote Controller

UTY-RSKY / UTY-RHKY (Without operation mode)



Without operation mode

Features

Compact remote controller provides access to basic functions

- Up to 16 indoor units can be controlled with one remote controller.
- Suitable for hotels or offices as it is easily operated with no complex functions.
- 3-wire type

Max. Controllable
16 indoor units

Easy-to-use operation

- Provides access to basic operations, such as Start / Stop, Fan control, Operation mode switching, and Room temperature setting.
- A large On / Off button is provided in the centre of the remote controller for easy operation.
- Can be used jointly with other individual control unit.
- Following an error display, diagnostics can be carried out on the controller.

Backlight

- Backlight enables easy operation in a darkened room.
- Backlight activates during all button operations, and lasts 10 seconds in Operation mode and 5 seconds in stop mode after a button is pressed.



Simple installation

Can be mounted on the European Mounting Box (Installation dimension: 60mm) or the JIS Built-in Box (Installation dimension: 83.5mm).

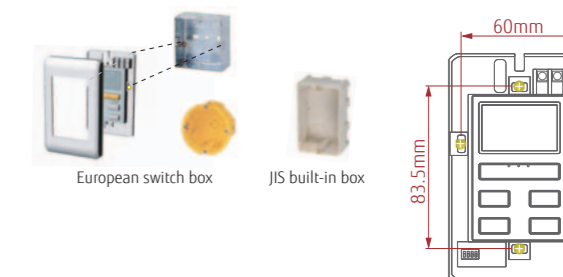

Functions

Model	UTY-RSKY	UTY-RHKY
Operation	●	●
On / Off	●	●
Fan control	●	●
Operation mode	●	—*1
Room temp. setting	●	●

*1: "Operation mode" setting is not available. It is recommend to use together with other type controller.

Specifications

Model name	UTY-RSKY	UTY-RHKY
Power Source	DC 12 V	DC 12 V
Dimensions (H × W × D) (mm)	120 × 75 × 14	120 × 75 × 14
Weight (g)	90	90

DC12 V is supplied by the indoor unit.

Wireless Remote Controller

UTY-LNHY



Features

Simple and sophisticated operations with a choice of 4 daily timers

- A single controller controls up to 16 indoor units.

Built-in timers

4 timer programs: On / Off / Program / Sleep

Program timer: Operates ON/OFF timer once within 24 hours

Sleep timer: Corrects the set temperature automatically during sleep time

Easy installation and operation

Code selector switch prevents indoor unit mix-up (up to 4 codes)
Wide and precise transmitting range

Max. Controllable
16 indoor units

Selectable
4 daily timers

IR Receiver Unit

UTB-YWC



Features

Necessary to control for all Duct types* by Wireless Remote Controller

*Only Large Airflow Duct can not be connected to IR Receiver Unit.

IR Receiver Unit

UTY-LRHYB1



Features

Cassette type indoor unit can be controlled with Wireless Remote Controller

Specifications

Model name	UTY-LNHY	UTB-YWC	UTY-LRHYB1
Battery	1.5 V (R03 / LR03 / AAA) × 2	DC 5 V	DC 5 V
Dimensions (H × W × D) (mm)	170 × 56 × 19	145 × 90 × 30	193.9 × 193.9 × 31.2
Weight (g)	85	150	140

DC12 V is supplied by the indoor unit.

Group Remote Controller

UTY-CGGY

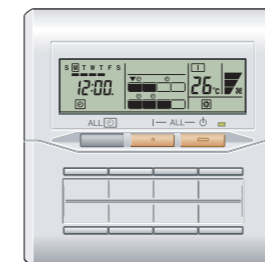

Features

Group control of indoor units with simple operation

- Up to 8 remote controller groups can be controlled by one Group Remote Controller.
- Up to 64 Group Remote Controllers can be connected in one VRF network system.
- Network Converter is required to connect Group Remote Controllers to a VRF network system. (Network Converter allows up to 4 Group Remote Controllers)
- 3-wire type

Max. Controllable
8 remote controller groups

Max. Controllable
64 group R.C. in a VRF network system

Control up to 8 remote controller groups

- Single Group Remote Controller controls and monitors up to 8 remote controller groups.

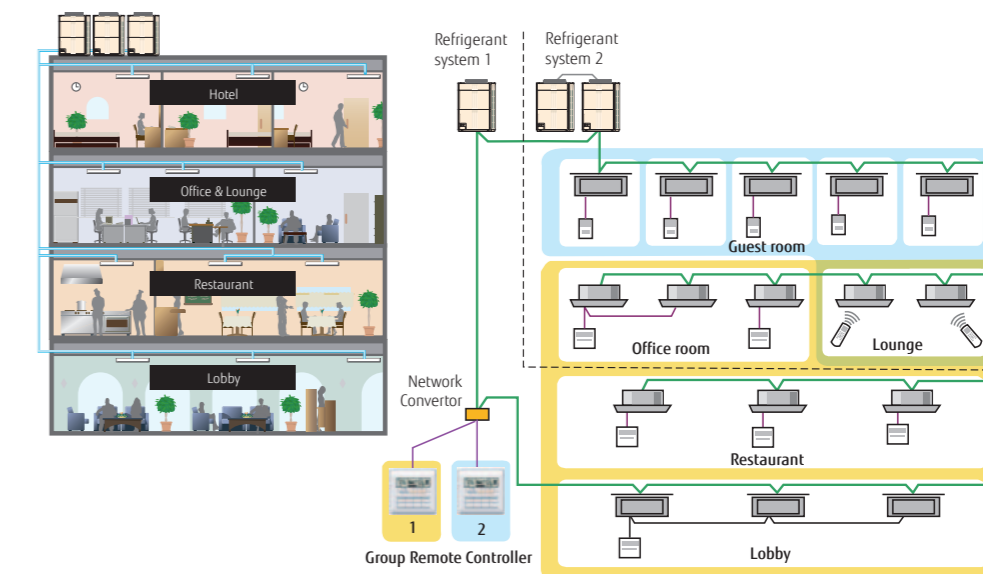

Group Remote Controller 1:
To control office room, lounge, restaurant and lobby (8 remote controller groups)
Group Remote Controller 2:
To control guest room and lounge (7 remote controller groups)

High performance and compact size

ON / OFF, Operating mode, Room temperature and Fan speed setting can be controlled / monitored centrally or individually.



Built-in weekly timers

The weekly timer is provided as a standard function.

Specifications

Model name	UTY-CGGY
Power Supply	DC 12 V
Dimensions (H × W × D) (mm)	120 × 120 × 18
Weight (g)	200

DC12 V is supplied by the indoor unit.

Central Remote Controller

UTY-DCGY



Features

For small- and medium-sized buildings and tenants

- Individual control and monitor of 100 indoor units
- 5 inch TFT color screen
- High visibility and easy operation
- External input / output contact
- Detachable power supply unit
- Corresponds to 7 different languages like English, Chinese, French, German, Spanish, Russian, Polish.

Max. Controllable
100 indoor units

Max. Controllable
16 groups

System overview

- It allows multiple indoor units grouping (Max.16 groups controlled)
- Interlock with external device

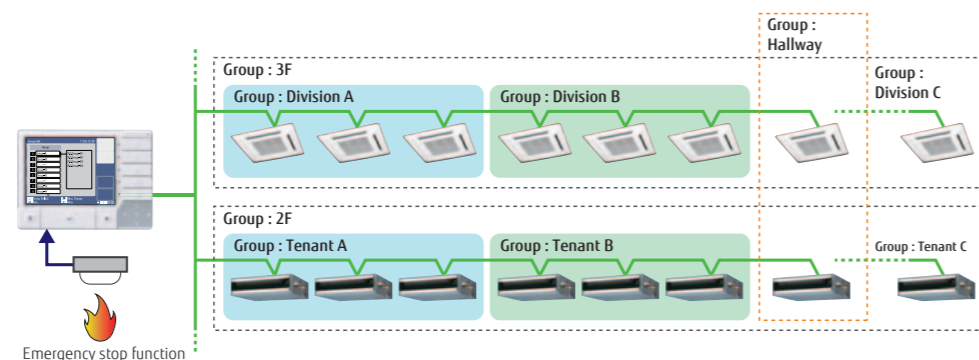

Easy Installation

- The control panel and power supply unit can be installed separately.
- For flexibility in installation, the Control panel can be built into the wall or fix on the wall.

Setting pattern 1

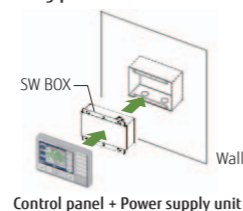

Setting pattern 2

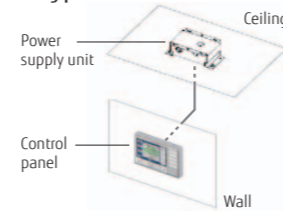

Functions

- Diverse control of indoor units
- Weekly timer
- Automatic clock adjustment
- Error history

Specifications

Model name	UTY-DCGY	
	Control Panel	Power Supply Unit
Power Supply	DC 5 V	100-240 V, 50-60Hz, Single phase
Dimensions (H × W × D) (mm)	120 × 162 × 25.7	99 × 135 × 39.2
Weight (g)	308	355

<PACKING LIST>

Packing List	Control Panel / Power Supply Unit / Connecting cable, etc.
--------------	--

NEW Touch Panel Controller

UTY-DTGYZ1



Features

- Large-sized 7.5-inch TFT color
- LCD Easy finger touch operation
- Stylish shape and design to suit all application
- No additional component is required for installation
- Up to 400 indoor units can be controlled
- Selectable 2 display types (Icon / List) in monitoring mode
- Corresponds to 7 different languages, English, Chinese, French, German, Spanish, Russian, Polish.

Max. Controllable
400 indoor units

Max. Controllable
100 outdoor units

Max. Controllable
400 groups

Diverse operation management

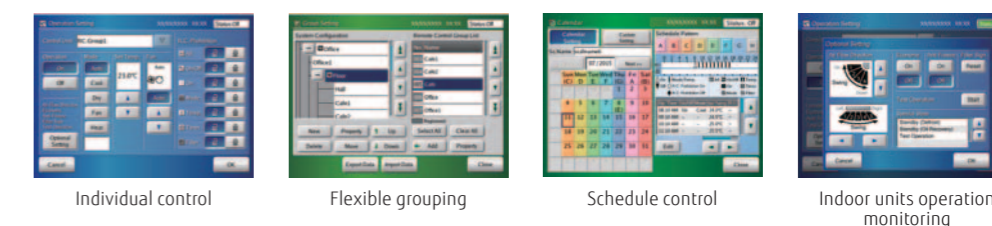

Remote monitoring and operation

- Air conditioner can be monitored and controlled via LAN from PC.
- Error contents are notified automatically by E-mail at error occurrence to handle the trouble promptly.

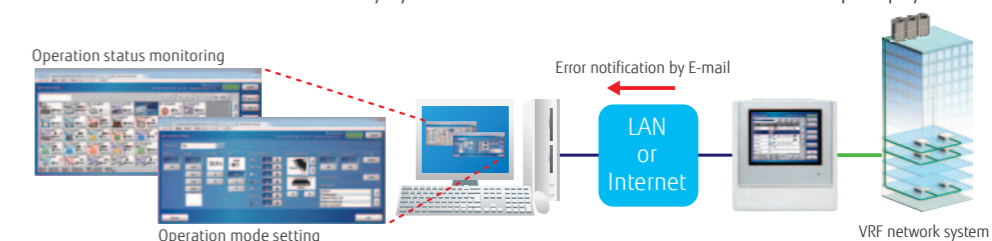

Electricity charge apportionment (Option: UTY-PTGXA)

- Electricity charge apportionment can be performed easily, when billing users for the air conditioning power consumed.

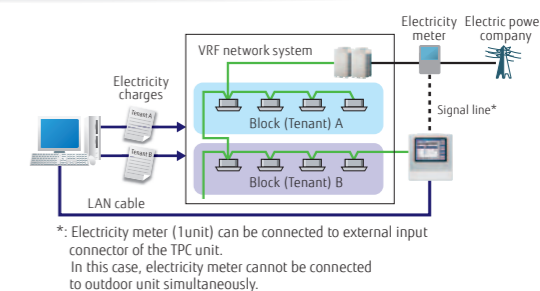

Easy installation

- Touch Panel Controller is easily mounted to the wall.
- Flat back surface allows to be installed wherever it is needed.
- No additional component is required for installation.



Specifications

Model name	UTY-DTGYZ1	UTY-PTGXA
Power Supply	100-240 V 50/60Hz, Single phase	DC 5V (USB Bus power)
Dimensions (H × W × D) (mm)	260 × 246 × 54	62 × 17 × 10
Weight (g)	2,150	9
Interface	Transmission/LAN/USB/EXT IN/EXT OUT/Reset SW	USB

System Controller

UTY-APGX **Software**

Features

Max. Controllable
4 VRF network systems

Max. Controllable
400 outdoor units

Max. Controllable
1,600 indoor units

System Controller realizes the advanced integrated monitoring & control of VRF network system from small scale buildings to large scale buildings.

- Up to a maximum of 4 VRF network systems, 1600 indoor units, and 400 outdoor units can be controlled.
- In addition to air conditioning precision control function, central remote control, electricity charge calculation, schedule management, and energy saving functions are strengthened and building manager and owner needs are met.
- Corresponds to 7 different languages (English, Chinese, French, German, Spanish, Russian, Polish)

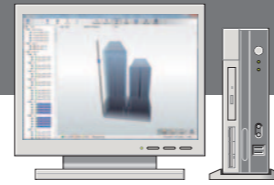

System Controller Lite

UTY-ALGX **Software**

Features

Max. Controllable
1 VRF network systems

Max. Controllable
100 outdoor units

Max. Controllable
400 indoor units

System Controller Lite has standard functions sufficient for air conditioner management in small and medium scale buildings .

- Up to a maximum of 1 VRF network system, 400 indoor units, and 100 outdoor units can be controlled.
- In addition to air conditioning precision control function, a variety of management software is available as an option to give customers a wide range of choice.
- Corresponds to 7 different languages (English, Chinese, French, German, Spanish, Russian, Polish)



High visibility and Easy operation

Click & Operate: The property is shown visually from the perspective most suitable for operation and operated accordingly (Click & Operate). You can select from among the 4 displays of site, building, floor, or list.

Freely define groups for batched control: Indoor units can be freely grouped for simple batched control from a tree menu. Grouping by hierarchal structure, such as by section, division or department is possible.

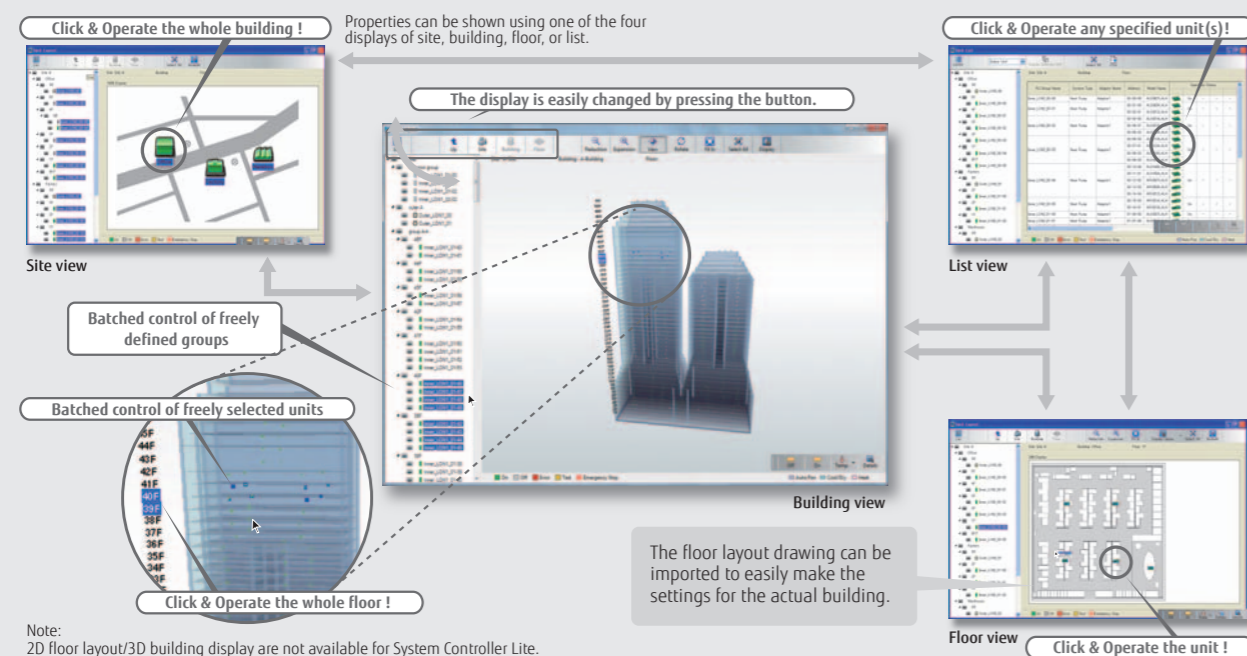

Diverse operation management & Data management

Standard for System Controller and System Controller Lite

Schedule management

- Annual schedules can be set for each remote controller group / user defined group.
- Start / stop, operating mode, remote controller prohibition, and temperature settings can be set up to 143 times per day at 10 minute intervals for up to 101 configurations for each remote controller group.
- Settings can be made for periods straddling midnight.
- Allows programming of special settings for holidays, including public holidays, for a complete year.
- Low noise operation of outdoor unit can be scheduled.

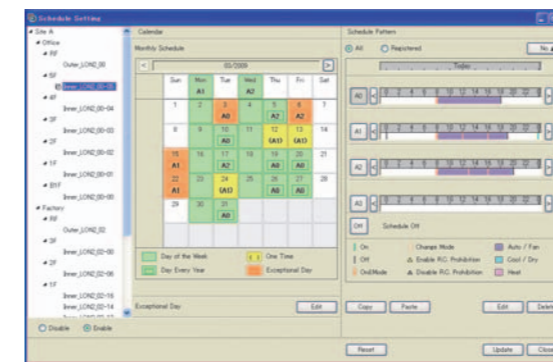

Diverse control of indoor unit and outdoor unit

- Indoor unit operation state, operation mode, etc. are displayed
- Indoor unit start / stop and operation mode switching
- Room temperature set point limitation
- Outdoor unit low noise setting

Remote controller prohibition

This prohibits changes to the operation mode, temperature, start/ stop, etc.

Error display & E-mail notification

Error is notified with popup message, audible sound and E-mail real time when error occurs. Error for the past 1 year are logged and can be reviewed later.

Operating & control record

Displays the history of operation status and control.

Data base import/export

Imports/exports registration data, layout data, and image data. Only the administrator can make this setting.

Automatic clock adjustment

The time setting of each controller can be set in batch automatically.

Electricity charge apportionment

Standard for System Controller

Option for System Controller Lite UTY-PLGX1

Electricity charge apportionment calculation framework

Suppose you want to find the power consumed by the air conditioners of each tenant from the electricity charge for each month. With electricity charge apportionment function, used energy apportionment ratio will be provided, calculating in detail the energy consumed by the units used by each tenant. This information is then used to calculate the charges for the electricity consumed for air conditioning by each tenant from the total electricity charges in the bill from the electric power company. (See figure at right)

The detailed calculation takes into consideration such things as unused rooms and nighttime electricity charges and shows them in a charges calculation sheet.

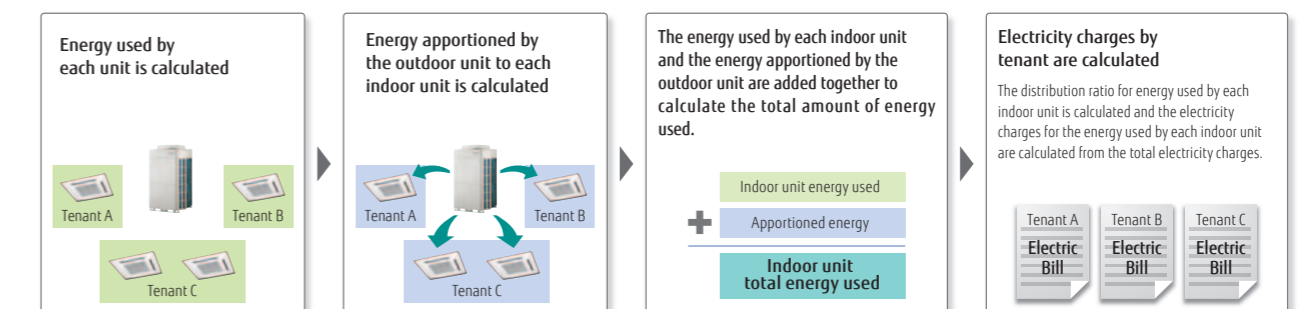
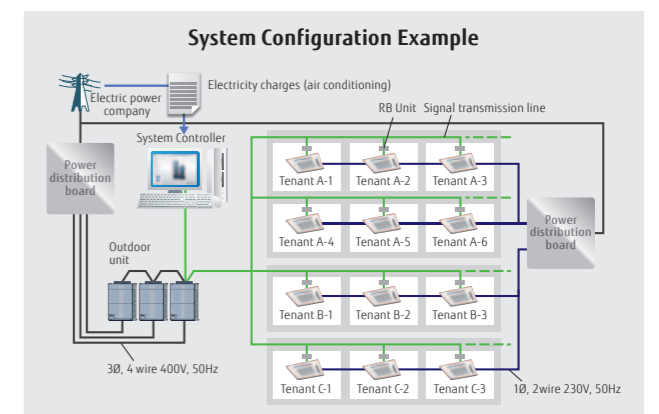

Remote management

Standard for System Controller

Option for System Controller Lite UTY-PLGXA1

System Controller may be used on site or remotely over various networks for remote central control. System Controller requires 2 softwares working together. VRF Controller runs on site and communicate with VRF system. VRF Explorer runs remotely and provides user interface and communicate with the VRF Controller. VRF Controller and VRF Explorer program may run in a single PC or in different PCs separated by network. By using VRF Explorer software, one PC can perform central control of 10 VRF system sites with max. 20 buildings per site.

On site central control

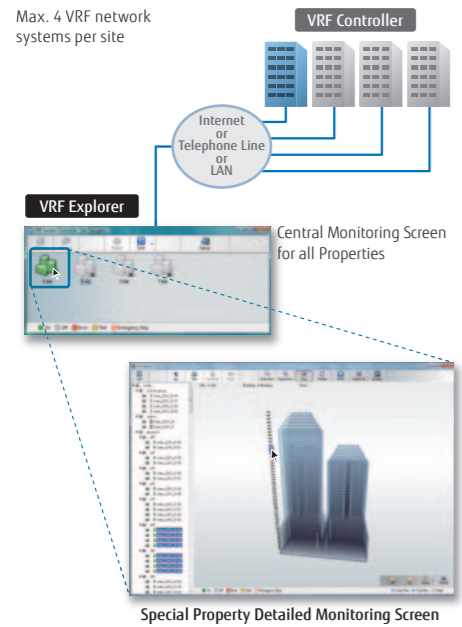

Remote central control

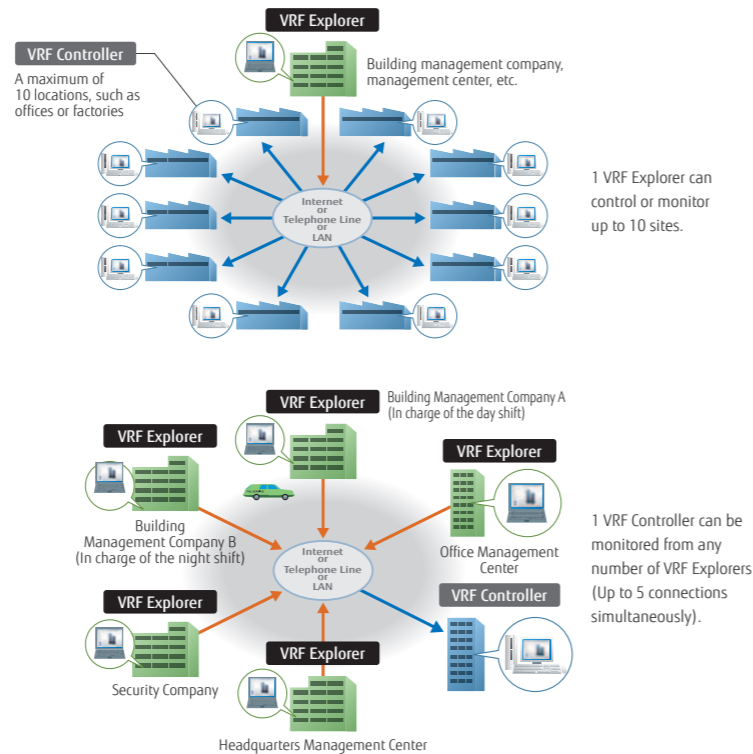

Energy saving management

Option for System Controller UTY-PEGX

Option for System Controller Lite UTY-PLGX1

A variety of energy saving operations can be set and managed depending on the season, weather, and time period. Excellent energy saving operation is performed while keeping users comfortable.



Energy Saving Management Main Screen

Energy saving graph data: This graph compares the electricity consumption with the previous month and previous year to make it easy to analyze the energy saving effect.

Indoor unit rotation operation

The operation of indoor units can be automatically rotated within a group in accordance with the set annual schedule to reduce power consumption while maintaining comfort. The indoor unit operation stoppage rate can be selected.

Peak cut operation

A power meter is connected to detect the total power consumption while shifting the indoor unit set temperature, set the indoor unit forced thermostat off, and taking other measures to carefully control the power consumed while maintaining comfort and conducting control to maintain the target power consumption set for each time. The indoor units to be controlled can be freely grouped and the control level can be set.

Outdoor unit capacity save

Outdoor unit capacity save switches the outdoor unit capability upper limit to suppress power consumption during hot summers and cold winters by averaging the power saving effect of each refrigerant system. You can select from 50% or more of the capacity upper limit.

FUNCTIONS SUMMARY

Function	Type	System controller					
		UTY-APGX	Option UTY-PEGX	UTY-ALGX	Option UTY-PLGX1	Option UTY-PLGX1	Option UTY-PLGX1
System specification	Max. VRF networks supported	4	-	1	-	-	-
	Max. indoor unit / remote controller groups per VRF network	400	-	400	-	-	-
	Max. outdoor units per System controller	100	-	100	-	-	-
	Max. indoor units / remote controller groups per System controller	1600	-	400	-	-	-
Site supervision	Max. outdoor units per System controller	400	-	100	-	-	-
	Multi site display	10	-	10	-	-	-
	Number of building / 1 site	20	-	-	-	-	-
	Number of floor per 1 site	200	-	-	-	-	-
	Number of floor per 1 building	50	-	-	-	-	-
	3D graphical layout view	○	-	-	-	-	-
	2D graphical layout view	○	-	-	-	-	-
	List display	○	-	○	-	-	-
	Tree display	○	-	○	-	-	-
	Group display	○	-	○	-	-	-
Error management	Error notification	○	-	○	-	-	-
	Audible alarm	○	-	○	-	-	-
	Error e-mail notification	○	-	○	-	-	-
	Error history	○	-	○	-	-	-
History	Operation history	○	-	○	-	-	-
	Control history	○	-	○	-	-	-
		○	-	○	-	-	-
Operation control	Individual control	On/Off	○	-	○	-	-
		Operation mode	○	-	○	-	-
		Room temperature	○	-	○	-	-
		Fan speed	○	-	○	-	-
		Air flow direction	○	-	○	-	-
		Economy mode	○	-	○	-	-
		Room temperature set point limitation	○	-	○	-	-
		Test operation	○	-	○	-	-
		Antifreeze	○	-	○	-	-
		Outdoor unit low noise setting	○	-	○	-	-
	Individual management	Remote control prohibition setting	○	-	○	-	-
		Temperature upper and lower limit setting	○	-	○	-	-
		Filter sign reset	○	-	○	-	-
		Memory operation	○	-	○	-	-
	Other	Pattern operation	○	-	○	-	-
			○	-	○	-	-
Schedule	Annual Schedule	○	-	○	-	-	
	Special day setting	○	-	○	-	-	
	On / off per day	72	-	72	-	-	
	On / off per week	504	-	504	-	-	
	Day off	○	-	○	-	-	
	Min. unit of timer setting (Minutes)	10	-	10	-	-	
Remote management	Low noise mode Weekly schedule	○	-	○	-	-	
	Remote monitoring	○	-	○	-	-	
	Remote operation control	○	-	○	-	-	
	Remote function setting	○	-	○	-	-	
Electricity charge apportionment	Apportionment charge/bill calculation	○	-	○	-	-	
	Tenant (block) setting	○	-	○	-	-	
	Common facilities apportionment setting	○	-	○	-	-	
	Rated power consumption allotment setting	○	-	○	-	-	
	Individual calculation at cooling and heating	○	-	○	-	-	
Energy saving management	Electricity meter supported	○*	-	○	-	-	
	Indoor unit rotation	○	-	○	-	○	
	Peak cut control	○	-	○	-	○	
	Outdoor unit capacity save	○	-	○	-	○	
	Record of energy saving operation	○	-	○	-	○	
	Energy saving information	○	-	○	-	○	
Others	Power consumption monitor	○	-	○	-	○	
	Electricity meter supported	○	-	○	-	○	
	Database import/export	○	-	○	-	○	
	Automatic clock adjustment	○	-	○	-	○	
Multi language	7 languages	-	7 languages	-	-		

*:Power calculation application software is necessary, please contact the local FGL representative.

○: Available. - : Not available.

Personal computer system requirements

	System Controller	System Controller Lite
Operating system	<ul style="list-style-type: none"> Microsoft® Windows Vista® Home Premium (32-bit) SP2, Windows Vista® Business (32-bit) SP2 Microsoft® Windows® 7 Home Premium (32-bit or 64-bit) SP1, Windows® 7 Professional (32-bit or 64-bit) SP1 Microsoft® Windows® 8 (32-bit or 64-bit), Windows® 8 Pro (32-bit or 64-bit) Microsoft® Windows® 8.1 (32-bit or 64-bit), Windows® 8.1 Pro (32-bit or 64-bit) Microsoft® Windows® 10 Home (32-bit or 64-bit), Windows® 10 Pro (32-bit or 64-bit) [Supported languages] English, Chinese, French, German, Russian, Spanish, and Polish	
CPU	Intel® Core™ i3 2 GHz or higher	
Memory	<ul style="list-style-type: none"> 2 GB or more (for Windows Vista® and Windows® 7 [32-bit]) 4 GB or more (for Windows® 7 [64-bit], Windows® 8, Windows® 8.1, and Windows® 10) 	
HDD	40 GB or more of free space	
Display	1024 x 768 or higher resolution	
Interface	<ul style="list-style-type: none"> Ethernet port (for getting access to the Internet using LAN) or Modem (for getting access to the Internet using Public Telephone Line) USB ports (Maximum of 6 ports) (Required only for the Server PC that works as VRF Controller) - Maximum of 2 USB ports are required for WibuKey connection - Maximum of 4 USB ports are required for Echelon® U10 USB Network Interface * Maximum number of required USB port depends on the applicable system configuration. 	<ul style="list-style-type: none"> Ethernet port (for getting access to the Internet using LAN) or Modem (for getting access to the Internet using Public Telephone Line) USB ports (Maximum of 5 ports) (Required only for the Server PC that works as VRF Controller) - Maximum of 4 USB ports are required for WibuKey connection - 1 USB port is required for Echelon® U10 USB Network Interface * The maximum number of required USB port depends on the applicable system configuration.
Graphic accelerator	Microsoft® DirectX® 9.0c compatible	
Software	Adobe® Reader® 9.0 or later	
Optical drive	DVD-ROM drive	

*Personal computer that satisfies the following system requirements

*Echelon® U10 USB Network Interface - TP/FT-10 Channel (Model number: 75010R) (Required for each VRF Network.)

PACKING LIST

Type	For System controller			For System controller Lite		
	System Controller	Option Energy manager	System Controller Lite	Remote access	Option Electricity charge apportionment	Energy saving
Model name	UTY-APGX	UTY-PEGX	UTY-ALGX	UTY-PLGX1	UTY-PLGX1	UTY-PLGX1
DVD-ROM	1	1	1	-	-	-
WibuKey*1(Software protection key)	1	1	1	1	1	1

*1: Software protection key to be inserted in a USB slot running System Controller or System Controller Lite.

System Controller or System Controller Lite may only run on a PC with Wibu Key. However, WibuKey is not required for remote VRF Explorer software.

BACnet® Gateway

UTY-ABGX Software

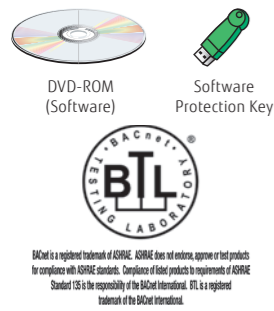

BACnet is a registered trademark of ASHRAE. ASHRAE does not endorse, approve or test products for compliance with ASHRAE standards. Compliance of listed products to requirements of ASHRAE Standard 135 is the responsibility of the BACnet International. BTL is a registered trademark of the BACnet International.

Features

- It is possible to connect medium to large sized BMS to VRF network system via BACnet®, a global standard for open networks.
- A maximum of 1600 indoor units with 4 VRF network systems (a maximum of 400 indoor units & 100 outdoor units for one network system) can be connected to one BACnet® Gateway.
- It is possible to control or monitor VRF network system from BMS via BACnet® Gateway.
- Compatible with BACnet® (ANSI / ASHRAE-135-2004) application specific controller (B-ASC).
- Compatible with BACnet®/IP over Ethernet.
- Scheduling function, Alarm & Event functions as well as Electricity Change Apportionment function are provided in BACnet® Gateway.
- Connection between VRF network system to personal computer is possible via small U10 USB interface. However, both U10 USB interface & personal computer are locally purchased items.
- Corresponds to 7 different languages, English, Chinese, French, German, Spanish, Russian, Polish.

Max. Controllable
4
VRF network systems

Max. Controllable
400
outdoor units

Max. Controllable
1,600
indoor units

Installation example

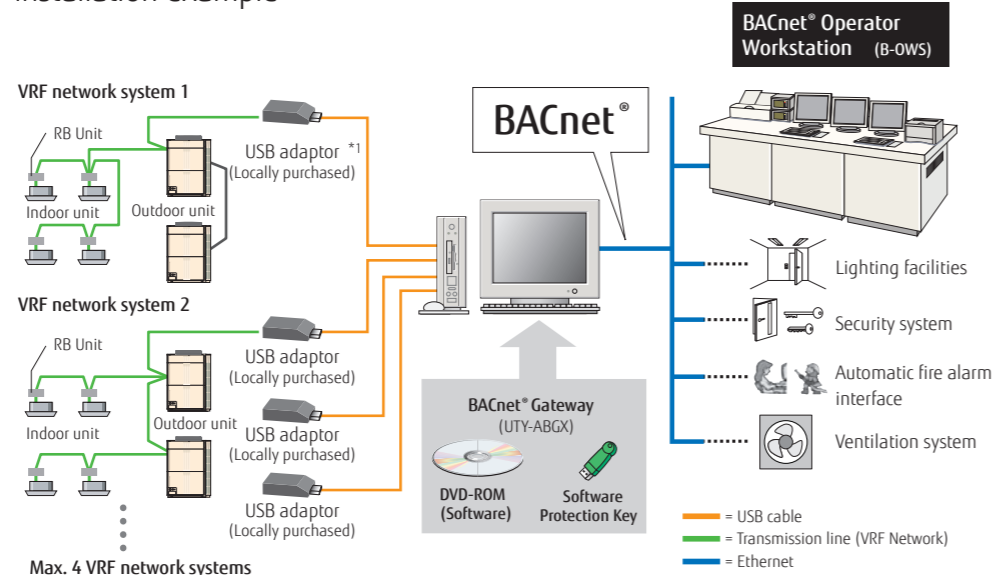

*1: USB adaptor is U10 USB Network Interface of Echelon® Corporation.

Personal computer system requirements

	UTY-ABGX
Operating system	<ul style="list-style-type: none"> • Microsoft® Windows Vista® Home Premium (32-bit) SP2, Windows Vista® Business (32-bit) SP2 • Microsoft® Windows® 7 Home Premium (32-bit or 64-bit) SP1, Windows® 7 Professional (32-bit or 64-bit) SP1 • Microsoft® Windows® 8 (32-bit or 64-bit), Windows® 8 Pro (32-bit or 64-bit) • Microsoft® Windows® 8.1 (32-bit or 64-bit), Windows® 8.1 Pro (32-bit or 64-bit) • Microsoft® Windows® 10 Home (32-bit or 64-bit), Windows® 10 Pro (32-bit or 64-bit) [Supported languages] English, Chinese, French, German, Russian, Spanish, and Polish
CPU	Intel® Core™ i3 2 GHz or higher
Memory	<ul style="list-style-type: none"> • 2 GB or more (for Windows Vista® and Windows® 7 [32-bit]) • 4 GB or more (for Windows® 7 [64-bit], Windows® 8, Windows® 8.1, and Windows® 10)
HDD	40 GB or more of free space
Display	1024 x 768 or higher resolution
Interface	<ul style="list-style-type: none"> • Ethernet port (for getting access to the Internet using LAN) • USB ports (Maximum of 5 ports) - 1 USB port is required for WibuKey connection - Maximum of 4 USB ports are required for Echelon® U10 USB Network Interface * Maximum number of required USB ports depends on the applicable system configurations.
Software	Adobe® Reader® 9.0 or later
Optical drive	DVD-ROM drive

<Packing list>

Name and shape	Quantity	Application
DVD-ROM	1	Includes the software and manuals for BACnet® Gateway.
WibuKey (Software protection key)	1	Software protection key to be connected to USB port on the BACnet®-installed PC. BACnet® Gateway runs only on a PC with WibuKey.

*Personal computer that satisfies the following system requirements
*Echelon® U10 USB Network Interface – TP/FT-10 Channel (Model number: 75010R) (Required for each VRF Network.)

Network Converter for LONWORKS®

UTY-VLGX

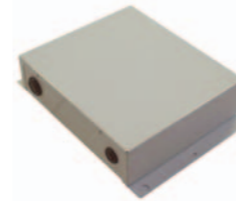

Features

- For connection between VRF network system and a LONWORKS® open network for management of small to medium-sized BMS and VRF network system.
- The UTY-VLGX permits central monitoring and control of a VRF network system from a BMS through a LONWORKS® interface.
- Up to 128 Indoor units can be connected to one Network Converter for LONWORKS®

Max. Controllable
4
units to BMS

Max. Controllable
100
outdoor units

Max. Controllable
128
indoor units

Installation example

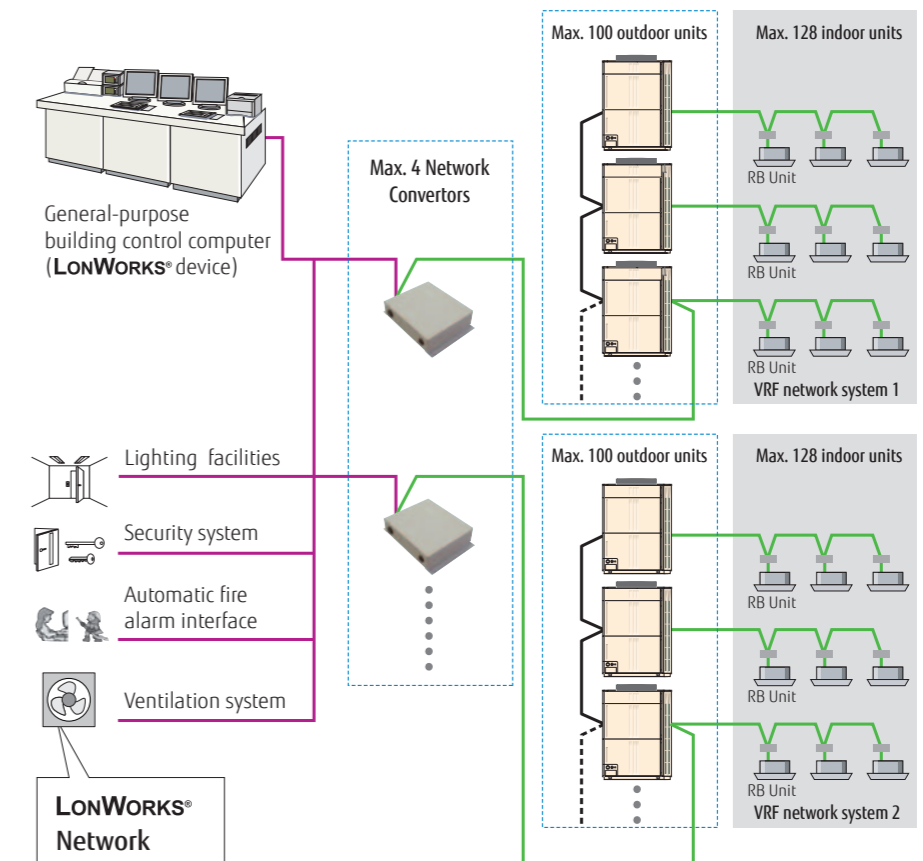

Specifications

Model name	UTY-VLGX
Power Supply	208-240V 50/60Hz, Single phase
Power Consumption (W)	4.5
Dimensions (H × W × D) (mm)	67 × 288 × 211
Weight (g)	1,500

Transmission specifications (BMS side)

Transmission speed	78 kbps
Transceiver	FT-X1 (Echelon® Corporation)
Transmission way form	Free topology
Terminal resistor	None (It attaches at the terminal of a network.)

Dimensions

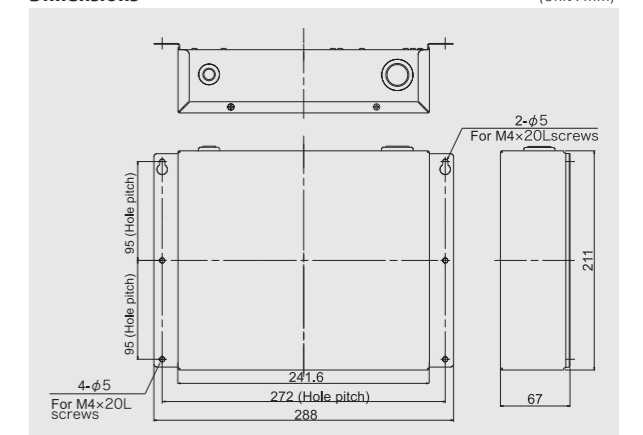

NEW MODBUS® Convertor

UTY-VMGX

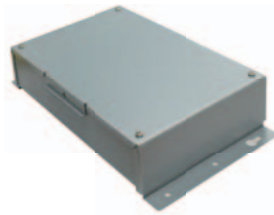

Features

The MODBUS Convertor allows a complete integration of air conditioners into MODBUS Networks.

- Compact and lightweight design
- Direct connection to MODBUS Network
- Up to 128 indoor units can be controlled in one MODBUS Convertor
- The MODBUS Convertor permits central monitoring and control of air conditioners from BMS or Central Controller.

Max. Controllable
9 units to one VRF

Max. Controllable
100 outdoor units

Selectable
128 indoor units

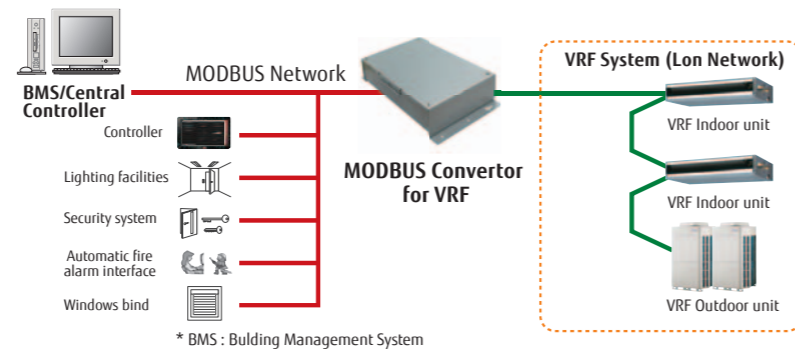

Connectable MAX 9

Up to 9 convertors can be connected to a VRF network. The simultaneous controls such as ON/OFF or temperature settings can be done for each zone.

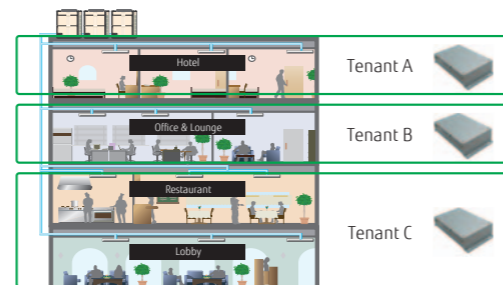

Traceability of sources of connection error

It is easy to locate the source of error if any connection errors should occur after completion of installation works.

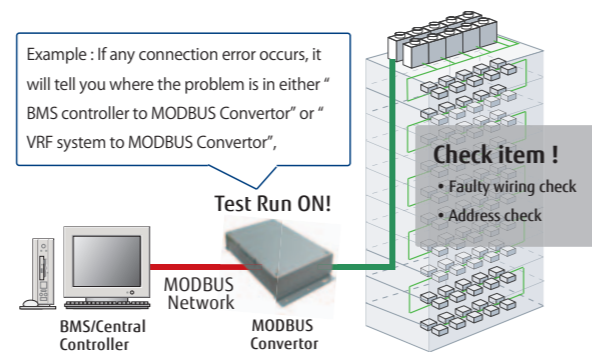

Specifications

Model name	UTY-VMGX
Power Supply	AC220/240V 50/60Hz
Input power (W)	Max. 2
Dimensions (H × W × D) (mm)	54 × 260 × 150
Weight (g)	1,100

MODBUS® Interface

FJ-RC-MBS-1



Features

The MODBUS Interface allows a complete integration of air conditioners into MODBUS Networks.

- Simple installation due to small and compact size.
- No separate external power supply required.
- The MODBUS Interface permits central monitoring and control of air conditioners from BMS.

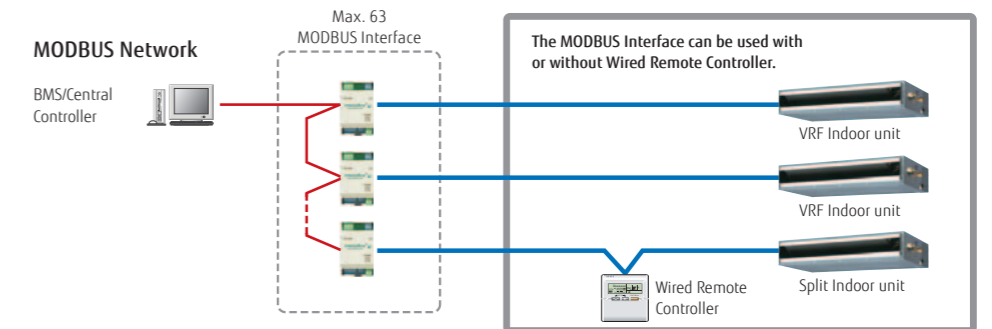

KNX® Interface

FJ-RC-KNX-1i



Features

The KNX Interface allows a complete integration of air conditioners with KNX Network systems.

- Simple installation due to small and compact size.
- No separate external power supply required (just KNX bus power).
- Can be used for single indoor units and group controlled (up to 16) indoor units.

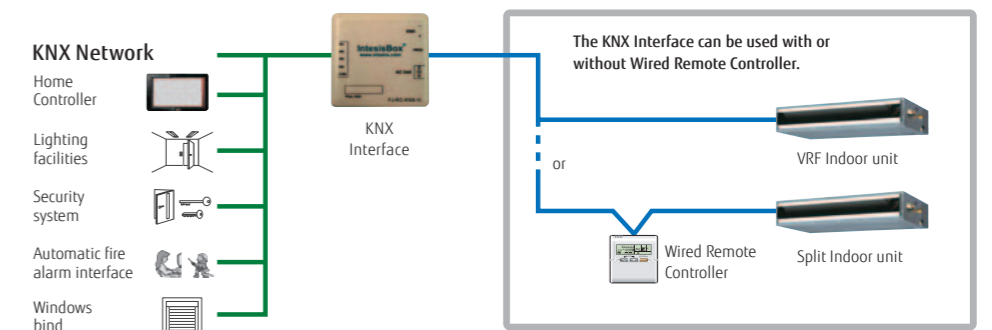

Specifications

Model name	FJ-RC-MBS-1
Dimensions (H × W × D) (mm)	93×53×58
Weight (g)	85

Model name	FJ-RC-KNX-1i
Dimensions (H × W × D) (mm)	70×70×28
Weight (g)	70

Wireless LAN Interface

FJ-RC-WIFI-1



Features



- It is the most advanced solution to remotely manage an Air Conditioning system using all sort of mobile devices such as Smartphones, Tablets and PC
- No separate external power supply required
- Can be used for single indoor units and group controlled (up to 16) indoor units

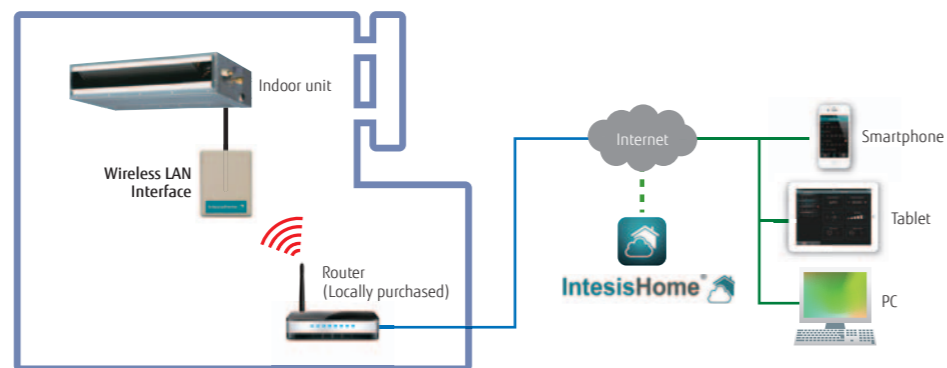

Basic control

- Turning the units on and off
- Mode control (Heat, Cool, Dry, Auto, Fan)
- Fan speed setting
- Louver position (Airflow direction setting)
- Room temperature display
- Set temperature control
- Multi Language
- One Scene and Timer



Advanced control (Optional functions)

- Climate working modes (ECO, Comfort, Powerful) (future release)
- Schedulable functionalities (ON/OFF, Modes, Set point temperature, Fan Speed, Louver position)
- Set temperature limitation (future release)
- Multiple Scenes & Timers and Calendar function

Notifications and history

- Alerts e-mail notification (future release)
- Air conditioning malfunction alerts
- Connectivity monitoring and alerts
- History (future release)

Specifications

Model name	FJ-RC-WIFI-1
Dimensions (H × W × D) (mm)	70×108×28
Weight (g)	80

External Switch Controller

UTY-TEKX

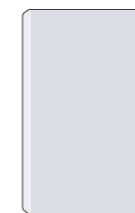

Features

Air conditioner switching can be controlled by connecting other sensor switches

- In combination with a field supply Card-Key Switch or other sensor, the External Switch Controller allows control of the ON / OFF, Room temperature, Fan speed and Master control functions. This makes this product suitable for installations such as hotel rooms.
- Card-key or other sensor switches are available as a locally purchased parts.

Installation example

Auto mode operation, which switches the cooling and the heating automatically, is enabled by using the sensor switch and External Switch Controller.

Note: All indoor units will operate in the same mode.

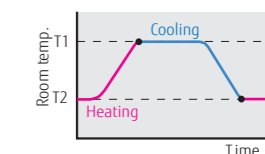
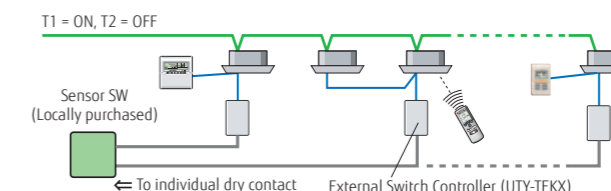

Note 1. Please choose a thermosensor switch which can be set up for T1 and T2.

Note 2. The remote controller's operation is prior to the auto mode operation.

Signal Amplifier

UTY-VSGXZ1

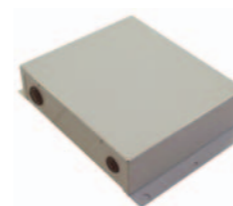

Features

- Transmission Line length can be extended up to 3,600m with multiple Signal Amplifiers.
- Up to 8 signal amplifiers can be installed in a VRF network system.
- A signal amplifier is required,
 - (1) When the total wiring length of the transnission line exceeds 500m.
 - (2) When the total number of units on the transnission line exceeds 64.

Installation example

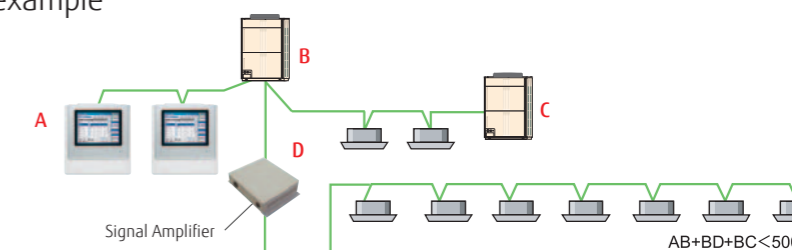

Specifications

Model name	UTY-TEKX
Power Supply	DC 12V
Dimensions (H × W × D) (mm)	120 × 75 × 30
Weight (g)	100

DC12V is supplied by the indoor unit.

Model name	UTY-VSGXZ1
Power Supply	208-240V 50/60Hz, Single phase
Power Consumption (W)	4.5
Dimensions (H × W × D) (mm)	67 × 288 × 211
Weight (g)	1,500

Network Convertor for single split

UTY-VTGX / UTY-VTGXV



UTY-VTGX
DC power supply type

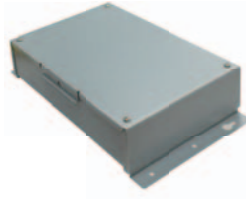

UTY-VTGXV
AC power supply type

Max. Controllable
16
single indoor units

Max. Controllable
100
Network Convertors

Features

- The network converters are required when connecting single split system to VRF network system.
- Compact and light weight design
- Connectable to both types of 2-wire and 3-wire remote controllers

Installation example.

- 2 types of 1 remote controller type and 2 remote controllers type are available.
- Power supply (AC220-240V, 50/60Hz) is required for 2 remote controllers type.

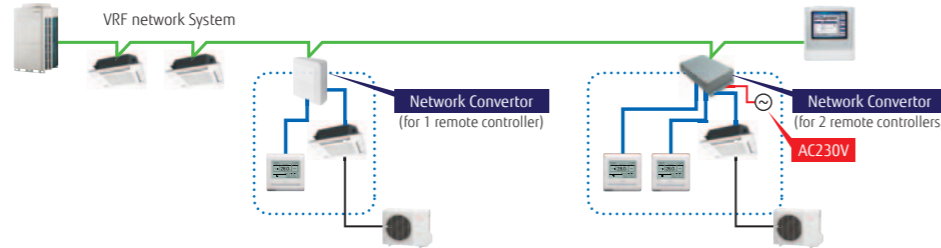

- 2-wire and 3-wire type of the wired remote controller can be connectable.

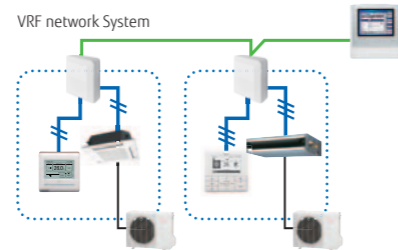

- A central control can be provided for the single split systems. (Up to 100 units of Network Converter is connectable in one VRF network system)

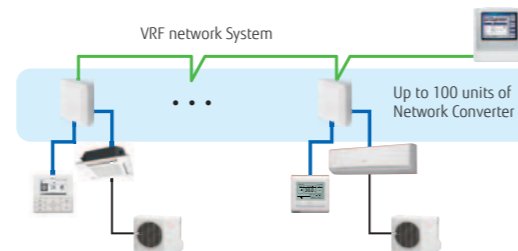

Specifications

Model name	UTY-VTGX		UTY-VTGXV
Power Supply	polar 3-wire DC12V	non-polar 2-wire DC12V	50/60Hz AC220/240V
Input power (W)	Max. 1.2		Max. 3
Dimensions (H × W × D) (mm)	43 × 117 × 140		54 × 260 × 150
Weight (g)	250		1,100

Network Convertor for Group Remote Controller

UTY-VGGXZ1

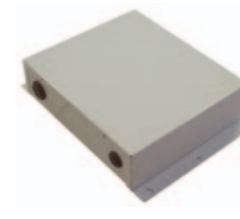

Features

- This network convertor is required when connecting Group Remote Controller to VRF network system.

Installation example

- 4 Group Remote Controllers can be connected to a single network convertor.
- 2 refrigerant circuits can be covered by a single network convertor.
- Up to a total of 16 network converters and central remote controller adaptors can be connected in a single VRF network system.

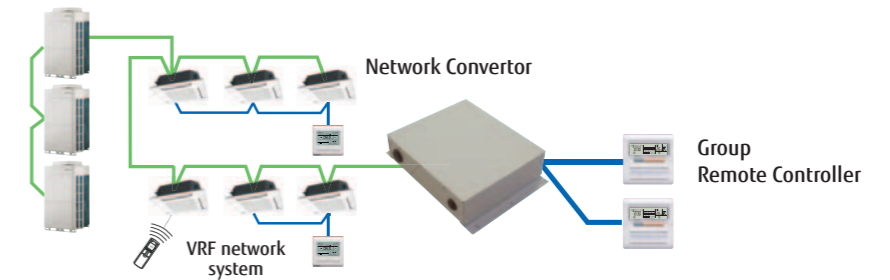

Max. Controllable
16
Network
Convertor units

Max. Controllable
4
Group Remote
Controllers

Specifications

Model name	UTY-VGGXZ1
Power Supply	208-240V 50/60Hz, Single phase
Power Consumption (W)	6.5
Dimensions (H × W × D) (mm)	67 × 288 × 211
Weight (g)	1,500

Service Tool

UTY-ASGX **Software**



Max. Monitor and control
100
outdoor units

Max. Monitor and control
400
indoor units

Features

Extensive monitoring and analysis functions for installation and maintenance

- Operation status can be checked and analyzed to detect even the smallest abnormalities
- Storage of data on system operation status on a PC allows access even from off site.
- Up to 400 indoor units (a single VRF network system) can be controlled and monitored for large scale buildings or hotels
- This software can be connected to any point of transmission line with USB adaptor (locally purchased)

Wiring connection

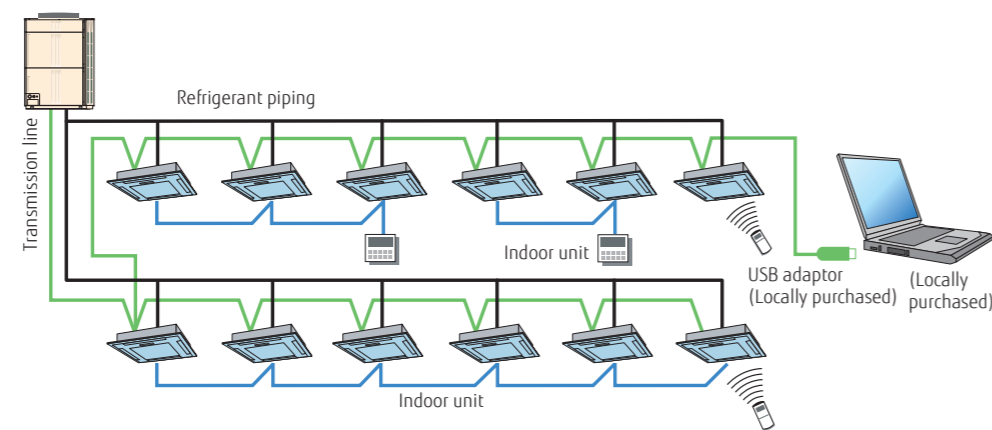

Functions

•Equipment Detail (Diagram)

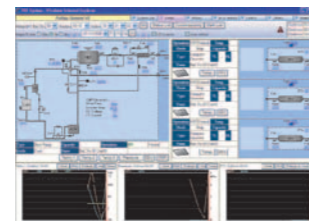

- Equipment Detail (List)
- Error History
- Remote File Download
- System List
- Commissioning Tool

Personal computer system requirements

	UTY-ASGX
Operating system	<ul style="list-style-type: none"> • Microsoft® Windows Vista® Home Premium (32-bit) SP2, Windows Vista® Business (32-bit) SP2 • Microsoft® Windows® 7 Professional (32-bit or 64-bit) SP1 • Microsoft® Windows® 8 Pro (32-bit or 64-bit) • Microsoft® Windows® 8.1 Pro (32-bit or 64-bit)
CPU	1 GHz or higher
Memory	<ul style="list-style-type: none"> • 1 GB or more (for Windows Vista®, Windows® 7 [32-bit], Windows® 8 [32-bit], and Windows® 8.1 [32-bit]) • 2 GB or more (for Windows® 7 [64-bit], Windows® 8 [64-bit], and Windows® 8.1 [64-bit])
HDD	10 GB or more of free space
Display	1024 x 768 or higher resolution
Interface	<ul style="list-style-type: none"> • 2 USB ports - 1 USB port is required for WibuKey connection - 1 USB port is required for Echelon® U10 USB Network Interface
Software	Internet Explorer® 8, 9, 10 or 11 / Adobe® Reader® 9.0 or later
Optical drive	DVD-ROM drive

<Packing list>

Name and shape	Quantity	Application
DVD-ROM	1	Includes the software and manuals
WibuKey (Software protection key)	1	Software protection key to be connected to USB port on the Service Tool-installed PC. These products runs only on a PC with WibuKey.

•Personal computer that satisfies the following system requirements
•Echelon® U10 USB Network Interface – TP/FT-10 Channel (Model number: 75010R) (Required for each VRF Network.)

Web Monitoring Tool

UTY-AMGX **Software**

VRF network system
can be supported

4

Max. Monitor and control
400
outdoor units

1,600
indoor units
can be supported

Features

Product features

- Troubleshooting is performed by monitoring each air conditioning unit remotely during periodical system checks.
- Error notification can be automatically transmitted to several locations using the internet*1.
- Requires either a dedicated internet connection or public telephone line.
- Determination of an error occurrence can be made through error warnings and equipment status information obtained from a remote location.
- The monitoring data in a remote side can be optionally downloaded. And, this data can be displayed in offline mode of the service tool.
- Monitoring side computer is not required to install special software, requires only general web browser.

*1: Use of internet mail system required.

Web Monitoring System

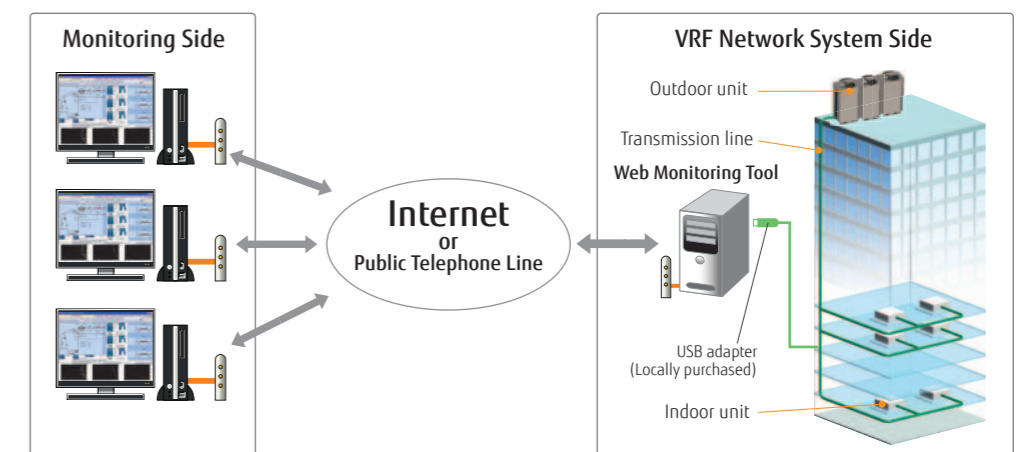

Support 4 VRF network systems

USB adaptor (max. 4 adaptors per PC) permit, monitoring of up to 1,600 indoor units. Suitable for large-scale buildings or hotels.

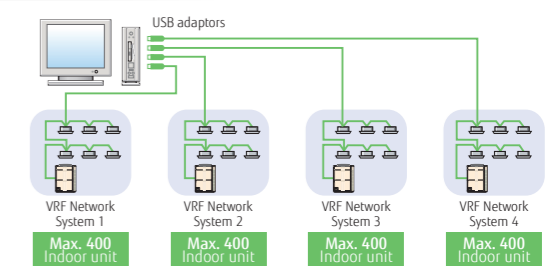

Personal computer system requirements

	UTY-AMGX
Operating system	<ul style="list-style-type: none"> • Microsoft® Windows Vista® Home Premium (32-bit) SP2, Windows Vista® Business (32-bit) SP2 • Microsoft® Windows® 7 Professional (32-bit or 64-bit) SP1 • Microsoft® Windows® 8 Pro (32-bit or 64-bit) • Microsoft® Windows® 8.1 Pro (32-bit or 64-bit)
CPU	1 GHz or higher
Memory	<ul style="list-style-type: none"> • 1 GB or more (for Windows Vista®, Windows® 7 [32-bit], Windows® 8 [32-bit], and Windows® 8.1 [32-bit]) • 2 GB or more (for Windows® 7 [64-bit], Windows® 8 [64-bit], and Windows® 8.1 [64-bit])
HDD	40 GB or more of free space
Display	1024 x 768 or higher resolution
Interface	<ul style="list-style-type: none"> • Ethernet port (for getting access to the Internet using LAN) or Modem (for getting access to the Internet using Public Telephone Line) • USB ports (Maximum of 5 ports) - 1 USB port is required for WibuKey connection - Maximum of 4 USB ports are required for Echelon® U10 USB Network Interface * Maximum number of required USB ports depends on the applicable system configurations.
Software	Internet Explorer® 8, 9, 10 or 11 / Adobe® Reader® 9.0 or later
Optical drive	DVD-ROM drive

<Packing list>

Name and shape	Quantity	Application
DVD-ROM	1	Includes the software and manuals
WibuKey (Software protection key)	1	Software protection key to be connected to USB port on the Service Tool-installed PC. These products runs only on a PC with WibuKey.

















•Personal computer that satisfies the following system requirements
•Echelon® U10 USB Network Interface – TP/FT-10 Channel (Model number: 75010R) (Required for each VRF Network.)

VENTILATION



Effective heat exchange and simultaneous fresh air ventilation

High Efficiency and low noise levels are achieved by using a highly efficient heat exchange process. A comfortable air conditioned space is achieved by conveniently selecting whether to use heat exchange or normal ventilation setting, according to the requirements of the conditioned space.

Airflow rate (m³/h)	250	350	500	800	1000	1500	2000			
Energy Recovery Ventilator Page 202	 UTZ-BD025B	 UTZ-BD035B	 UTZ-BD050B	 UTZ-BD080B	 UTZ-BD100B					
Outdoor Air Unit Page 204					 ARXH054GTAH	 ARXH072GTAH	 ARXH096GTAH			
Connectable Capacity class (kW)	5.0	6.3	8.0	10.0	12.5	14.0	20.0	25.0	40.0	50.0
DX-Kit for air handling applications Page 206	 EUV unit UTP-VX30A	 Control unit UTY-VDGX	 EUV unit UTP-VX60A	 Control unit UTY-VDGX	 EUV unit UTP-VX90A	 Control unit UTY-VDGX	 EUV unit UTP-VX90A × 2	 Control unit UTY-VDGX		

202 Energy Recovery Ventilator

204 Outdoor Air Unit

206 DX-Kit for air handling applications

Energy Recovery Ventilator

Energy recovery ventilator unit offers maximum comfort and greater energy savings.

Features

Adopts a highly efficient counter-flow heat exchange element

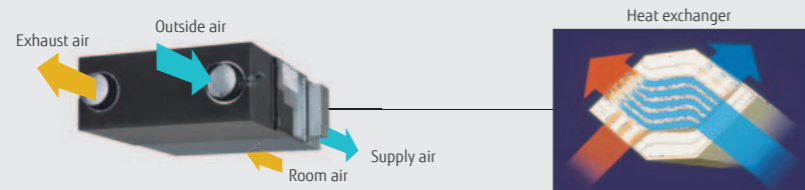

Heat exchange ventilation and normal ventilation

Heat exchange ventilation

When a room is cooled or heated, the exhausted cooling / heating energy is recovered by heat-exchange ventilation.

Normal ventilation

The operation is used during periods when the room space requires no cooling or heating effect, i.e. when there is minimal temperature difference between the indoor and outdoor environments.

Energy efficiency and ecology

Energy consumption is dramatically reduced by using a counter-flow heat-exchange element. Air conditioning load is reduced by approximately 20%, resulting in significant energy savings. Recovers up to 77% of the heat in the outgoing air.

Features of heat exchange element

With the cross-flow element, air moves in a straight line across the element. With the counter-flow element, air flows through the element for a longer time (longer distance), so the heat-exchange effect remains unchanged.

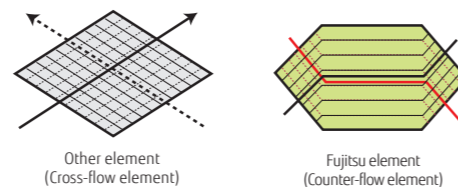

Quiet operation

Significantly reducing low pressure loss and noise allows low-noise operation.

Extended range of an external static pressure

An external static pressure is improved by adopting a powerful fan motor. This allows for application in a wide variety building.

Slim shape and easier installation

Counter-flow heat exchange element used for reduced noise and slimmer, more compact body shape.



Reverse mountable direct air supply / exhaust system

Adoption of straight air supply / exhaust system: Duct design is simplified because the air supply / exhaust ducts are straight. Since each unit can be mounted in reverse position, only one inspection hole is needed for two units: Two units can share one inspection hole so duct work is easier and more flexible.

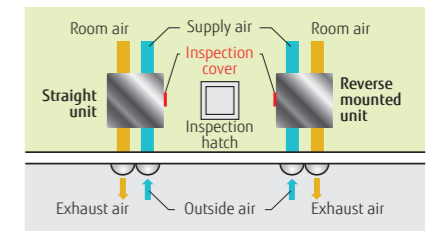

Model : UTZ-BD025B / UTZ-BD035B / UTZ-BD050B / UTZ-BD080B / UTZ-BD100B



Specifications

Rated flow rate				250 m ³ /h	350 m ³ /h	500 m ³ /h	800 m ³ /h	1000 m ³ /h
Model No.				UTZ-BD025B	UTZ-BD035B	UTZ-BD050B	UTZ-BD080B	UTZ-BD100B
Power source				220 - 240V, 50Hz				
Heat Exchange Ventilation	Input power	(Extra high)/High/Low	W	128 / 123 / 96	190 / 185 / 168	289 / 225 / 185	418 / 378 / 295	464 / 432 / 311
	Air flow rate	(Extra high)/High/Low	m ³ /h	250 / 250 / 190	350 / 350 / 240	500 / 500 / 440	800 / 800 / 630	1000 / 1000 / 700
	External static pressure	(Extra high)/High/Low	Pa	105 / 95 / 45	140 / 60 / 45	120 / 60 / 35	140 / 110 / 55	105 / 80 / 75
	Temperature Exchange Efficiency	(Extra high)/High/Low	%	75 / 75 / 77	75 / 75 / 78	75 / 75 / 76	75 / 75 / 76	75 / 75 / 79
	Energy Exchange Efficiency Cooling	(Extra high)/High/Low	%	63 / 63 / 65	66 / 66 / 71	62 / 62 / 64	65 / 65 / 68	65 / 65 / 70
Normal Ventilation	Energy Exchange Efficiency Heat pump	(Extra high)/High/Low	%	70 / 70 / 72	69 / 69 / 73	67 / 67 / 69	71 / 71 / 74	71 / 71 / 76
	Sound pressure level	(Extra high)/High/Low	dB*	31.5 / 30.5 / 26.5	33 / 31 / 25.5	37.5 / 35.5 / 32.5	37.5 / 37 / 34.5	38.5 / 37.5 / 34.5
	Input power	(Extra high)/High/Low	W	128 / 123 / 96	190 / 185 / 168	289 / 225 / 185	418 / 378 / 295	464 / 432 / 311
	Air flow rate	(Extra high)/High/Low	m ³ /h	250 / 250 / 190	350 / 350 / 240	500 / 500 / 440	800 / 800 / 630	1000 / 1000 / 700
	External static pressure	(Extra high)/High/Low	Pa	105 / 95 / 45	140 / 60 / 45	120 / 60 / 35	140 / 110 / 55	105 / 80 / 75
Sound pressure level	(Extra high)/High/Low	dB*	31.5 / 30.5 / 26.5	33 / 31 / 25.5	38.5 / 38 / 32.5	37.5 / 37 / 34.5	40.5 / 39.5 / 36.5	
Dimensions	W×D×H	mm		882 x 599 x 270	1050 x 804 x 317	1090 x 904 x 317	1322 x 884 x 388	1322 x 1134 x 388
Weight		kg		29	49	57	71	83
Outlet duct diameter		mm		150	150	200	250	250
Operation range		°C		-10 to 40	-10 to 40	-10 to 40	-10 to 40	-10 to 40
Maximum humidity		%		85	85	85	85	85

* The noise level must be measured 1.5 m below the centre of the unit.

Dimensions

(Unit : mm)

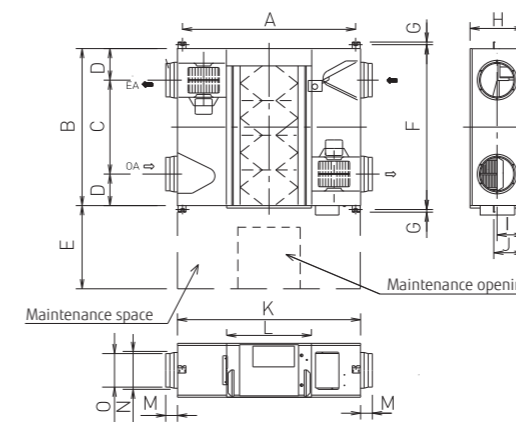

	UTZ-BD025B	UTZ-BD035B	UTZ-BD050B	UTZ-BD080B	UTZ-BD100B
A	810	978	1018	1250	1250
B	599	804	904	884	1134
C	315	580	640	428	678
D	142	112	132	228	228
E	600	600	600	600	600
F	655	860	960	940	1190
G	19	19	19	19	19
H	270	317	317	388	388
I	135	159	159	194	194
J	159	182	182	218	218
K	882	1050	1090	1322	1322
L	414	470	470	612	612
M	95	70	127	85	85
N	219	162	210	258	258
O	144	144	194	242	242

Outdoor Air Unit

The heat pump method efficiently processes the outdoor air for cooling and heating and supplies 100% fresh air into a room.

Features

One VRF system can provide air conditioning and air supply at the same time.

Outdoor Air Unit can be connected in a same VRF*1 system as one of indoor unit series and can create fresh and comfortable air supply together from our high advanced technology.

*1. Connectable VRF series: J-IIS, J-II, V-II, VR-III In J-II series alone, OAU is prohibit to connect under the ambient temperature of 40°C or higher.

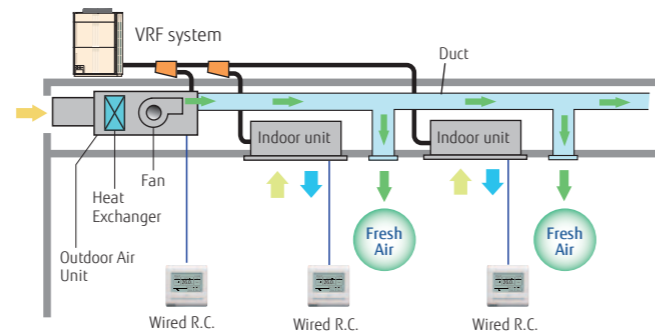
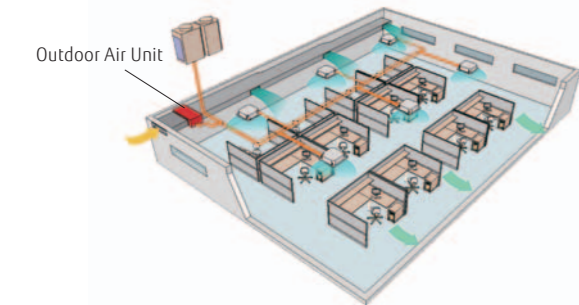

* Make sure the connected capacity is within the range of 50% to 100% of the outdoor unit capacity. In addition, if there are mixed connections with indoor units, make the Outdoor Air Unit connection capacity 30% or less of the outdoor unit capacity.

High energy savings and flexible duct design by using DC motor

- Greatly reduces electricity consumption by adopting permanent magnet compared to when using an AC motor.
- Compared with AC motor, changing the speed makes it possible to respond flexibly to the external static pressure from 50 Pa to 240 Pa. Even if damper equipment is not used, static pressure can be adjusted and duct design is easy.
- Static pressure can be set easily using wired remote controller.

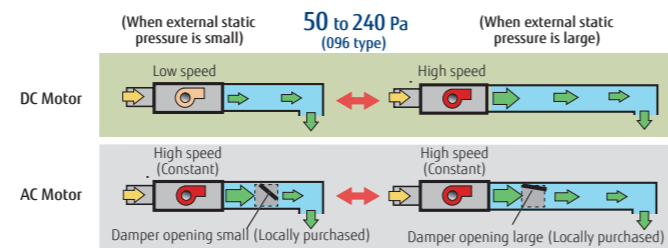

Top class compact design

- Top class lightweight compact design at just 425 mm in height, 55 kg in weight for ARXH072 type. This unit can be installed easily even at narrow space.

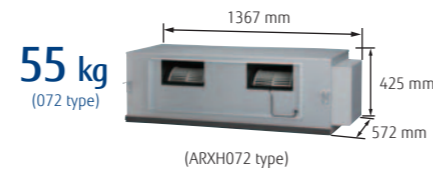

Various Controller

Supplied variety of controllers as options, such as individual controller, central controller, and building management controller.

Individual Controller

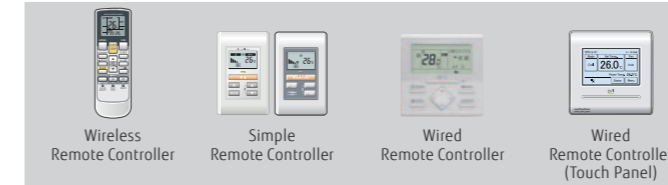

Central Controller



* The temperature setting is discharged air temperature setting. The air volume is set to a constant speed.

Model : ARXH054GTAH / ARXH072GTAH / ARXH096GTAH Production by order



ARXH054GTAH



ARXH072GTAH



ARXH096GTAH

Specifications

Model name			ARXH054GTAH	ARXH072GTAH	ARXH096GTAH
Power source	V/Ø/Hz		230/1/50	230/1/50	230/1/50
	Capacity	Cooling	14.0	22.4	28.0
Input Power	Cooling/Heating	Heating	8.9	13.9	17.4
		W	179	292	370
Airflow Rate		m ³ /h	1,080	1,680	2,100
Static Pressure	Standard (range)		185 (50-185)	200 (50-200)	200 (50-240)
		Pa			
Sound Pressure Level		dB (A)	42	44	47
Dimensions (H x W x D)		mm	425×1,367×572	425×1,367×572	450×1,583×700
Weight		kg	48	55	71
Connection Pipe Diameter (Small / Large)			Ø9.52/Ø19.05	Ø12.70/Ø22.22	Ø12.70/Ø22.22
		mm			
Operation Range	Cooling	°CDB	5 to 43	5 to 43	5 to 43
		Heating	-7 to 21	-7 to 21	-7 to 21
Refrigerant			R410A	R410A	R410A

Note : Specifications are based on the following conditions.

Cooling : Outdoor temperature of 33°CDB / 28°CWB.
Heating : Outdoor temperature of 0°CDB / -2.9°CWB.

Pipe length : 7.5 m Voltage : 230 [V].

Dimensions

(Unit : mm)

ARXH054GTAH

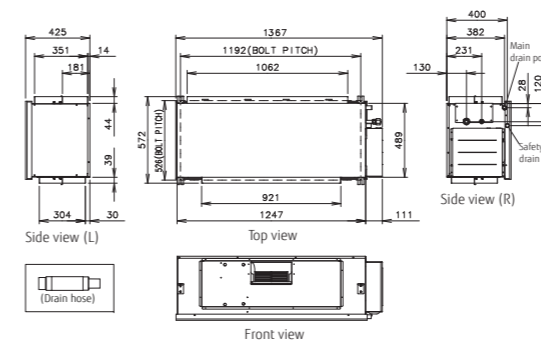

ARXH072GTAH

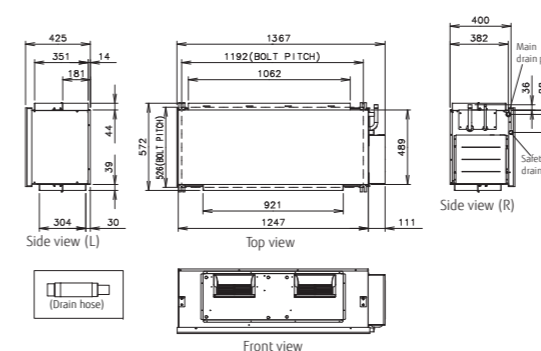

ARXH096GTAH

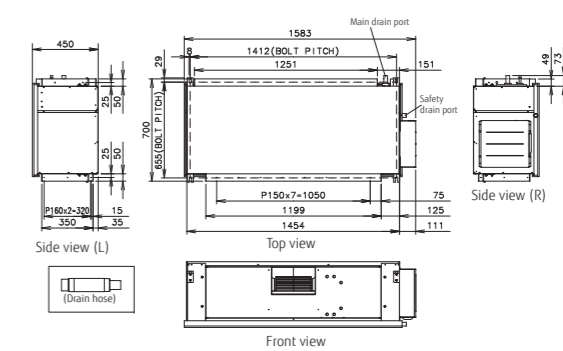

DX-Kit For Air Handling Applications

These kits enable other manufacturers air handling units (AHU) and fan coil units (FCU) to be incorporated into a Fujitsu VRF system or, be connected to a dedicated Fujitsu VRF outdoor unit as a 1:1 system to control outside air ventilation (AHU) or room temperature (FCU).

Features

Multiple temperature sensors optimally control the air handling unit and fan coil unit.

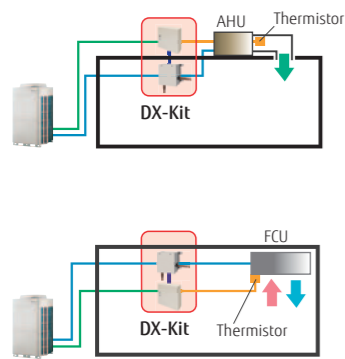

When connecting to an air handling unit, the supply air temperature is controlled by the discharge sensor.

When connecting to a fan coil unit, the room temperature is controlled by the return air temperature sensor.

Arrangement as part of a VRF system

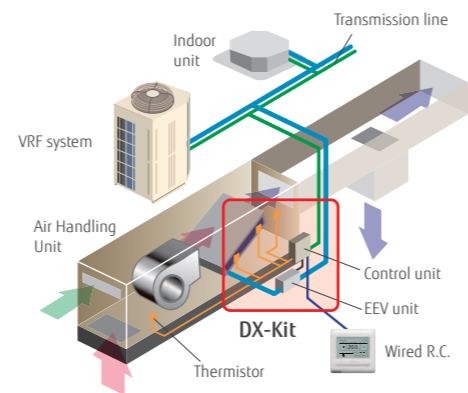

Supports a wide range of capacity classes

- 2 EEV units can be connected in parallel and up to 20 HP (50 kW) large capacity units. (Separation Tube of UTP-LX180A is required.)
- Connectable capacity range: 5 kW to 50 kW

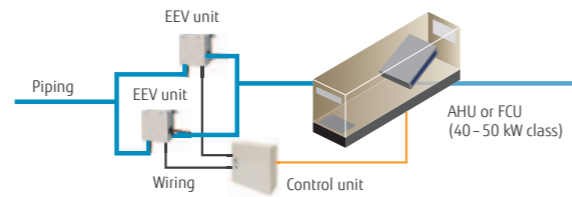

A variety of controls to match the application

Central control using our VRF controllers or central management controllers

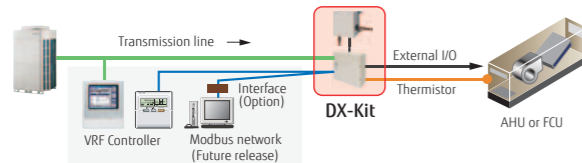

Central control from external controllers

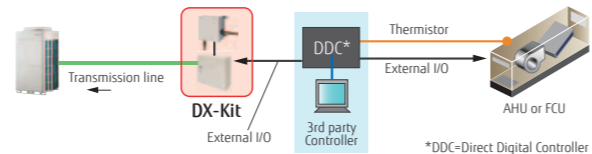

Functions Summary

Inputs

- ON/OFF
- Setting temperature
- Capacity demand
- Heating / Cooling operation mode
- Fault information

Outputs

- ON/OFF indication
- Fan ON/OFF indication
- Thermo ON/OFF indication
- Defrost indication
- Fault indication

MODBUS® Control

Possible to control via a MODBUS enabled BMS by using optional interface.

For 2EEV units connection (option) Separation Tube: UTP-LX180A



Installation Limitation

- Connectable VRF series: J-IIS, J-II, V-II, VR-II
- Connectable DX-Kit system capacity range: 50 to 100% of the outdoor unit capacity
- Connectable DX-Kit system capacity range with indoor units: 30% or less of the outdoor unit capacity
- Max. wiring length from control unit: 10 m
- Max. piping length between EEV unit and indoor unit: 5 m
- Outdoor installation: Control unit (IP54 class) and EEV unit can be installed at an outdoor space.

Connectable capacity

• Single connection



• Mixed connection

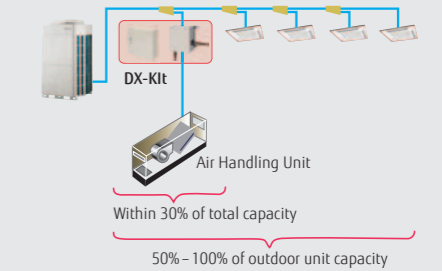

Piping and wiring length

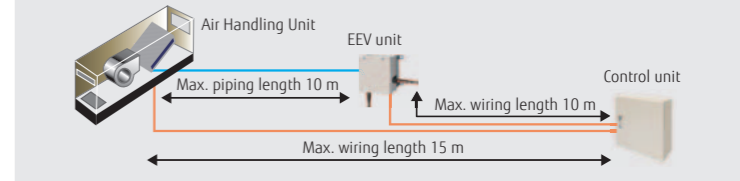

Control unit: UTY-VDGX EEV unit: UTP-VX30A / UTP-VX60A / UTP-VX90A

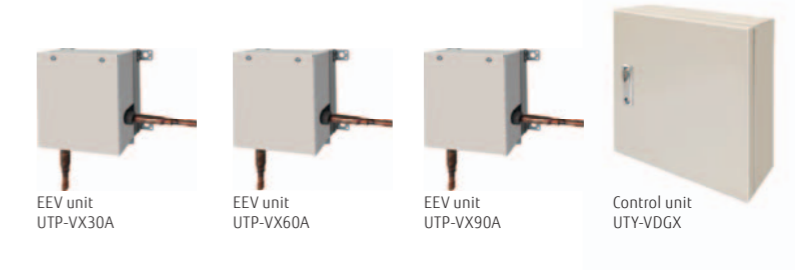

Specifications



Connectable Capacity class		5.0 kW	6.3 kW	8.0 kW	10.0 kW	12.5 kW	14.0 kW	20.0 kW	25.0 kW	40.0 kW	50.0 kW
Capacity	Cooling	5.6	6.3	8.0	10.0	12.5	14.0	22.4	25.0	40.0	50.4
	Heating	6.3	7.1	9.0	11.2	14.0	16.0	25.0	28.0	45.0	56.5
Control unit		UTY-VDGX									
Power source	V/Ø/Hz	230/1/50									
Dimensions (H × W × D)	mm	400 × 400 × 120									
EEV unit		UTP-VX30A		UTP-VX60A		UTP-VX90A		UTP-VX90A×2			
Connection pipe diameter (Liquid)	mm	Ø9.53		Ø12.7		Ø12.7		Ø12.7			
Dimensions (H × W × D)	mm	160 × 220 × 90									

Note: Specifications are based on the following conditions.
Cooling: Indoor temperature of 27°CDB / 19°CWB, and outdoor temperature of 35°CDB / 24°CWB.
Heating: Indoor temperature of 20°CDB / (15°CWB), and outdoor temperature of 7°CDB / 6°CWB.
Pipe length: 7.5 m Voltage: 230 [V].

OPTIONAL PARTS FOR VRF

Connection Units

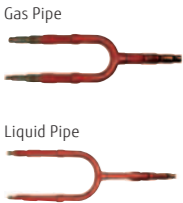
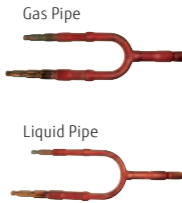
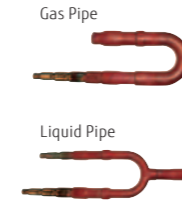
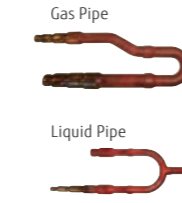
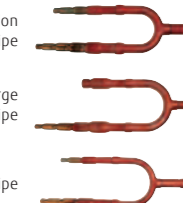
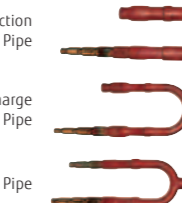
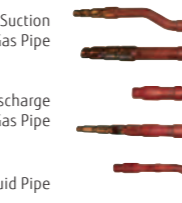
Separation Tube

 <p>Gas Pipe</p> <p>Liquid Pipe</p> <p>UTP-AX054A</p>	 <p>Gas Pipe</p> <p>Liquid Pipe</p> <p>UTP-AX090A</p>	 <p>Gas Pipe</p> <p>Liquid Pipe</p> <p>UTP-AX180A</p>	 <p>Gas Pipe</p> <p>Liquid Pipe</p> <p>UTP-AX567A</p>
 <p>Suction Gas Pipe</p> <p>Discharge Gas Pipe</p> <p>Liquid Pipe</p> <p>UTP-BX090A</p>	 <p>Suction Gas Pipe</p> <p>Discharge Gas Pipe</p> <p>Liquid Pipe</p> <p>UTP-BX180A</p>	 <p>Suction Gas Pipe</p> <p>Discharge Gas Pipe</p> <p>Liquid Pipe</p> <p>UTP-BX567A</p>	<p>For DX-Kit</p>  <p>UTP-LX180A</p>

Header

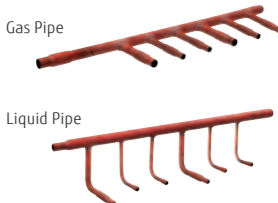
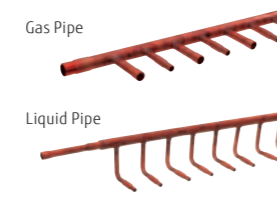
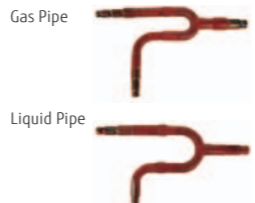
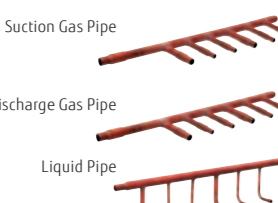
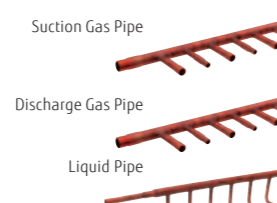
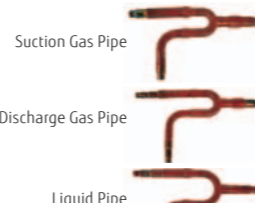
 <p>Gas Pipe</p> <p>Liquid Pipe</p> <p>UTR-H0906L / UTR-H1806L</p>	 <p>Gas Pipe</p> <p>Liquid Pipe</p> <p>UTR-H0908L / UTR-H1808L</p>	 <p>Gas Pipe</p> <p>Liquid Pipe</p> <p>UTP-CX567A</p>
 <p>Suction Gas Pipe</p> <p>Discharge Gas Pipe</p> <p>Liquid Pipe</p> <p>UTR-J0906A / UTR-J1806A</p>	 <p>Suction Gas Pipe</p> <p>Discharge Gas Pipe</p> <p>Liquid Pipe</p> <p>UTP-J0908A / UTP-J1808A</p>	 <p>Suction Gas Pipe</p> <p>Discharge Gas Pipe</p> <p>Liquid Pipe</p> <p>UTP-DX567A</p>

Outdoor Unit Branch Kit



EV Kit

For Compact Wall Mounted type



Model code ≦ 09 : UTR-EV09XB
Model code ≧ 12 : UTR-EV14XB

RB Unit

 <p>Single type</p> <p>UTP-RX01AH / UTP-RX01BH / UTP-RX01CH</p>	 <p>Multi type</p> <p>UTP-RX04BH</p>
--	--

Specifications

Separation Tube

Model name	UTP-AX054A	UTP-AX090A	UTP-AX180A	UTP-AX567A
Total cooling capacity of indoor unit (kW)	19.6 or less	28.0 or less	28.1 to 56.0	56.1 or more
Model name	UTP-BX090A		UTP-BX180A	UTP-BX567A
Total cooling capacity of indoor unit (kW)	28.0 or less		28.1 to 56.0	56.1 or more

Header

Model name	3-6 Branches	UTR-H0906L	UTR-H1806L
	3-8 Branches	UTR-H0908L	UTR-H1808L
Total cooling capacity of indoor unit (kW)	28.0 or less		28.1 to 56.0
Model name	3-6 Branches	UTP-J0906A	UTP-J1806A
	3-8 Branches	UTP-J0908A	UTP-J1808A
Total cooling capacity of indoor unit (kW)	28.0 or less		28.1 to 56.0

Outdoor unit Branch kit

Model name	UTP-CX567A (for V-II/V-III)		UTP-DX567A (for VR-II)
Number of outdoor unit	2 outdoor units	1	
	3 outdoor units	2	

EV Kit

Model name	UTR-EV09XB	UTR-EV14XB
Application model	ASYE04GACH ASYE07GACH ASYE09GACH	ASYE12GACH ASYE14GACH







RB Unit

Type	Single type			Multi type	
Model name	UTP-RX01AH	UTP-RX01BH	UTP-RX01CH	UTP-RX04BH	
Power source	V/∅/Hz	230/ 1 / 50			
Input power	W	17	24	31	96
Number of branches		1	1	1	4
Maximum capacity of connectable indoor units (Q)	kW	Q ≥ 8.0	Q ≤ 18.0	Q ≤ 28.0	Q ≤ 56.1*1
Maximum capacity of connectable indoor units per branch (Q)	kW	Q ≥ 8.0	Q ≤ 18.0	Q ≤ 28.0	Q ≤ 18.0
Maximum number of connectable indoor units per branch		3	8	8	8
Dimensions (H×W×D)	mm	198×298×268			260×658×428



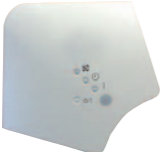

*1: In case of two RB units connected in series (total 8-branches), maximum capacity of connectable indoor units is up to 56.0 kW.

Controllers

For Individual Control





<p>Wired Remote Controller (Touch Panel) UTY-RNRYZ1 NEW</p> 	<p>Wired Remote Controller UTY-RLRY</p> 	<p>Simple Remote Controller UTY-RSKY With operation mode</p> 
<p>Simple Remote Controller UTY-RHKY Without operation mode</p> 	<p>Wireless Remote Controller UTY-LNHY</p> 	<p>IR Receiver Unit UTB-YWC For All Duct types except Large Airflow Duct</p> 
<p>IR Receiver Unit UTY-LRHYB1 For Cassette type</p> 		

For Centralized Control

<p>Group Remote Controller UTY-CGGY</p> 	<p>Central Remote Controller UTY-DCGY</p> 	<p>Touch Panel Controller UTY-DTGYZ1 NEW</p> <p>Option UTY-PTGXA</p> 
<p>System Controller Lite Software UTY-ALGX</p> <p>Option UTY-PLGXA1 UTY-PLGXR1 UTY-PLGXE1</p> 	<p>System Controller Software UTY-APGX</p> <p>Option UTY-PEGX</p> 	

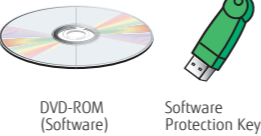
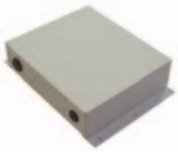
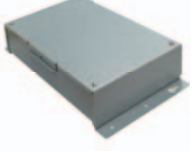
Converters / Adaptors

For External device

<p>BACnet® Gateway Software UTY-ABGX</p>  <p>DVD-ROM (Software) Software Protection Key</p>	<p>Network Converter for LONWORKS® UTY-VLGX</p> 	<p>MODBUS® Converter for VRF UTY-VMGX NEW</p> 
<p>MODBUS® Interface FJ-RC-MBS-1</p> 	<p>KNX® Interface FJ-RC-KNX-1i</p> 	<p>Wireless LAN Interface FJ-RC-WIFI-1</p> 

For System expansion

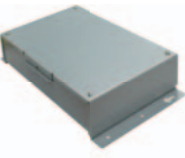
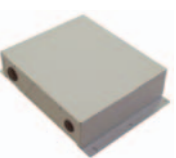
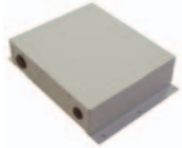
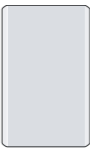
<p>Network Converter for single split UTY-VTGX NEW</p> 	<p>Network Converter for single split UTY-VTGXV NEW AC power supply type</p> 	<p>Network Converter for Group Remote Controller UTY-VGGXZ1</p> 
<p>Signal Amplifier UTY-VSGXZ1</p> 	<p>External Switch Controller UTY-TEKX</p> 	

Panels

For Cassette type

<p>Cassette Grille UTG-UFYC-W For Compact Cassette type</p> 	<p>Cassette Grille UTG-UGYA-W For Cassette type</p> 
--	--

Others

Communication system: External Connect Kit

For Indoor unit		For Outdoor unit	
UTY-XWZXZ7		UTY-XWZXZD	
UTY-XWZXZB		UTY-XWZXZE	
UTY-XWZXZC			

For RB unit		For Central Remote Controller		For Touch Panel Controller	
UTY-XWZXZ6		UTY-XWZXZ7		UTY-XWZXZA	
UTY-XWZXZB		UTY-XWZXZ8			
		UTY-XWZXZA			

Function list

	Indoor unit	Outdoor unit	Controller		Other RB Unit
			Central Remote Controller	Touch Panel Controller	
Operation / Stop	●UTY-XWZXZD ○UTY-XWZXZB	—	—	—	—
All On / All Off	—	—	●UTY-XWZXZ7 ○UTY-XWZXZB	●*3 ○*3	—
Batch Stop	—	●UTY-XWZXZ6	—	—	—
Forced Stop	●UTY-XWZXZD ○UTY-XWZXZB	—	—	—	—
Emergency Stop	●UTY-XWZXZD ○UTY-XWZXZB	●UTY-XWZXZ6	●UTY-XWZXZ7 ○UTY-XWZXZB	●*3 ○*3	—
Forced Thermostat off	●UTY-XWZXZE ○UTY-XWZXZ7	—	—	—	—
Low Noise Mode Operation	—	●UTY-XWZXZ6	—	—	—
Cooling / Heating Priority	—	●UTY-XWZXZ6*1	—	—	●UTY-XWZXZ6 ○UTY-XWZXZB
Outdoor Unit Operation Peak Control	—	●UTY-XWZXZ6	—	—	—
Power Usage Information from Electricity Meter	—	●UTY-XWZXZF	—	●*3 ○*3	—
Operation Status	●UTY-XWZXZC	○UTY-XWZXZ6	○UTY-XWZXZA	○UTY-XWZXZA	—
Error Status	●UTY-XWZXZC	○UTY-XWZXZ6	○UTY-XWZXZA	○UTY-XWZXZA	—
Indoor Unit Fun Operation Status	●UTY-XWZXZC	—	—	—	—
Auxiliary Heater Output	●UTY-XWZXZC*2	—	—	—	—
Base Heater	—	●UTY-XWZXZ9	—	—	—

*1. Heat Pump type only
 *2. Duct type only
 *3. Touch Panel Controller has these functions for Dry contact and Apply voltage, however, above External Connect Kit is not necessary because Touch Panel Controller has an external input terminal block.

●: Dry Contact ○: Apply Voltage

For Duct type

Flange (Round) UTD-RF204 For Medium Static Pressure Duct type / Ceiling type 	Flange (Square) UTD-SF045T For Medium Static Pressure Duct type 	Remote Sensor Unit UTY-XSZX For All Duct type New amenity space can be offered by installing the Remote sensor.
Long-Life Filter UTD-LF25NA For Medium Static Pressure Duct type 	UTD-LF60KA For High Static Pressure Duct type 	Auto Louver Grille Kit UTD-GXTA-W (for ARXD04/07/09/12/14GALH) (for ARXK07/09/12/14GCLH) UTD-GXTB-W (for ARXD18GALH) (for ARXK18GCLH) UTD-GXTC-W (for ARXD24GALH) (for ARXK24GCLH) For Slim Duct type / Mini Duct type
		Drain Pump Unit UTZ-PX1BBA For Low Static Pressure Duct type UTZ-PX1NBA For Medium Static Pressure Duct type

For Cassette type

Wide Panel UTG-AKXA-W For Cassette type 	Panel Spacer UTG-BKXA-W For Cassette type 	Insulation Kit for High Humidity UTZ-KXRA For Cassette type UTZ-KXGC For Compact Cassette type
Fresh Air Intake Kit UTZ-VXAA For Compact Cassette type 	UTZ-VXRA For Cassette type 	Air Outlet Shutter Plate UTR-YDZB For Compact Cassette type Shuts the air outlet when only using as 3 blow out.
		Air Outlet Shutter Plate UTR-YDZK For Cassette type Shuts the air outlet when only using as 3 blow out.

For Ceiling type

Drain Pump Unit UTR-DPB24T For Ceiling type
--

AIR TO WATER



WATERSTAGE™ makes an Economical and Clean hot water heating system by Heat Pump





















Complete Solution meets various needs

The clean energy produced by WATERSTAGE™ reliably delivers “comfort” to all spaces in the home up to the living room, bedrooms, bath, and swimming pool.

WATERSTAGE™

- 216 All Type Lineup
- 218 Split Type
- 218 Split DHW Integrated Type
- 220 Monobloc Type
- 221 Smart & Comfort Control
- 222 Case Studies
- 224 Optional Parts
- 226 Installation Limitations
- 227 Specifications & Dimensions

All Type Lineup

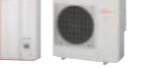
Capacity (kW)	5	6	8	10	11	14	16
Split	High Power series Single phase Page 218 Hydraulic Indoor Unit / Outdoor Unit						
	High Power series 3 phase Page 218 Hydraulic Indoor Unit / Outdoor Unit						
	Comfort series Page 218 Hydraulic Indoor Unit / Outdoor Unit						
Split DHW integrated	High Power series Single phase Page 218 Hydraulic Indoor Unit / Outdoor Unit						
	High Power series 3 phase Page 218 Hydraulic Indoor Unit / Outdoor Unit						
	Comfort series Page 218 Hydraulic Indoor Unit / Outdoor Unit						
Monobloc	Compact series with hydraulic unit Page 220 Hydraulic Indoor Unit / Outdoor Unit						

EHPA Quality label



Fujitsu General's WATERSTAGE* have obtained the EHPA Quality Label** by tests according to the international Standards EN14511 and EN17025. The EHPA Quality Label** is a label that shows the end-consumer a quality heat pump unit on the market.

*: High Power split model
**: Check the validity of label at www.ehpa.org/QL

SG-Ready Label



SG-Ready is a defined standard by BWP***, which makes it possible that the device can be integrated into a smart grid. Heat pumps, which are equipped with the SG-Ready Label, can receive signals from the power grid (and e.g. also from PV systems) about the available (unused renewable) energy (from wind, sun & water). Fujitsu General provides the SG-Ready compatibility to all new Heat Pumps series.

***BWP: the Federal German Heat Pump Association

What's a Heat Pump ?

Absorbing free energy from the atmosphere. Heat pump system requires only 1 kW of electricity to generate 3 to 5 kW thermal energy.

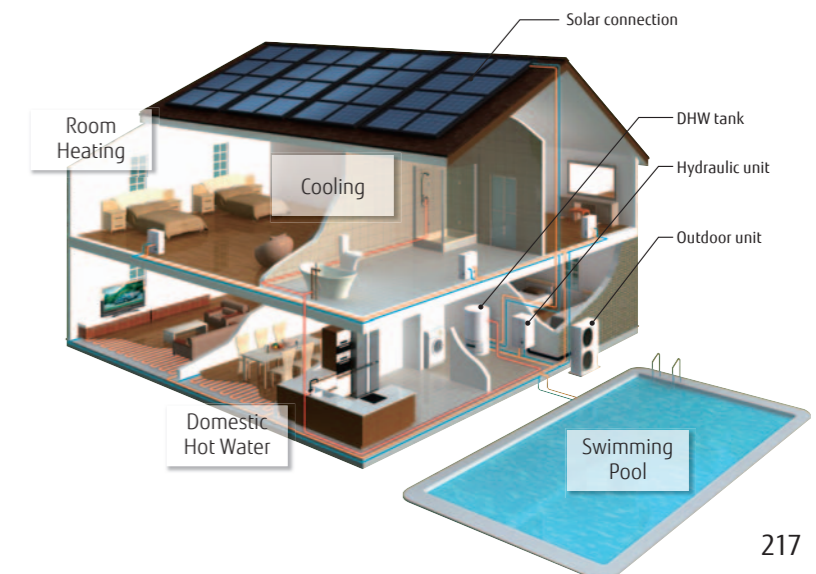
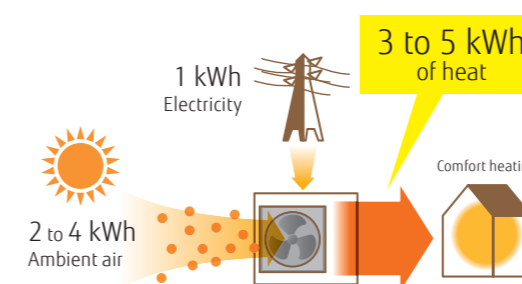

Split Type High power Series/Comfort series



High power series
 Hydraulic indoor unit: WSYG140DG6/[3phase] WSYK160DG9
 Outdoor unit: WOYG112LCTA/WOYG140LCTA [3phase] WOYK112LCTA/WOYK140LCTA/WOYK160LCTA

Comfort series
 Hydraulic indoor unit: WSYA050DG6/WSYA100DG6
 Outdoor unit: WOYA060LFCA/WOYA080LFCA/WOYA100LFTA



Split DHW Integrated Type High power Series/Comfort series

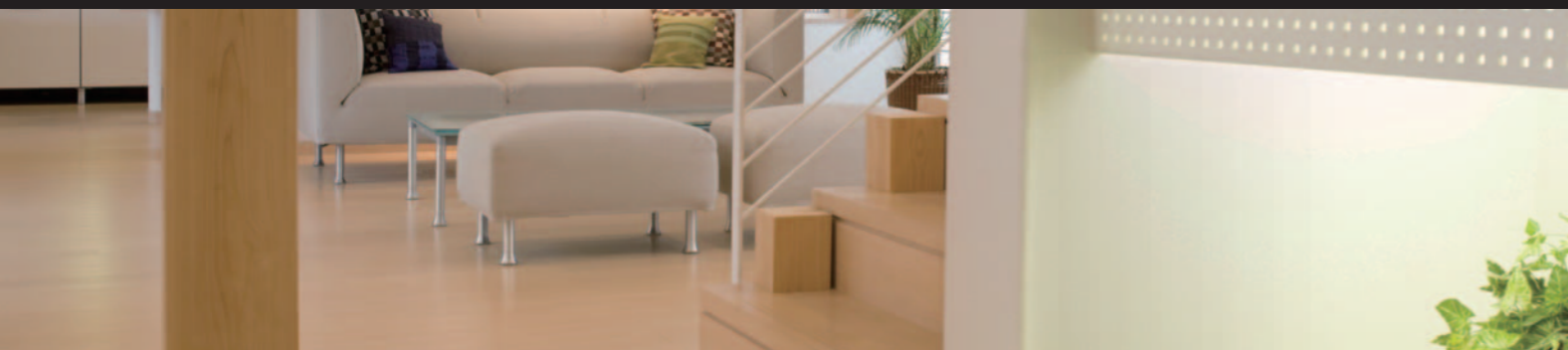

High power series
 Hydraulic indoor unit: WGYG140DG6/[3phase] WGYK160DG9
 Outdoor unit: WOYG112LCTA/WOYG140LCTA [3phase] WOYK112LCTA/WOYK140LCTA/WOYK160LCTA

Comfort series
 Hydraulic indoor unit: WGYA050DG6/WGYA100DG6
 Outdoor unit: WOYA060LFCA/WOYA080LFCA/WOYA100LFTA

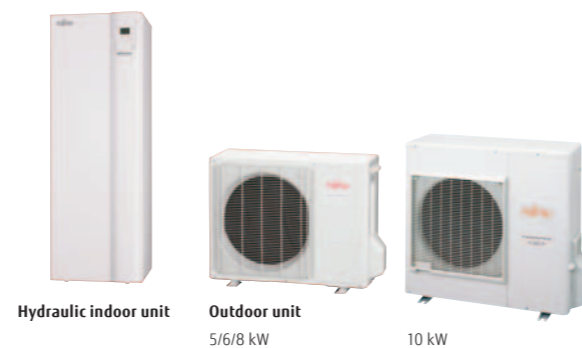

Features

High leaving water temperature

High power series: High leaving water temperature of 60°C is kept even when outdoor temperature is down to -20°C without using backup heaters.

Comfort series: Maximum leaving water temperature is 55°C without backup heater. Hot water supply temperature can be maintained even at -10°C outdoor temperature.

At -20°C outdoor temperature: 60°C Hot water

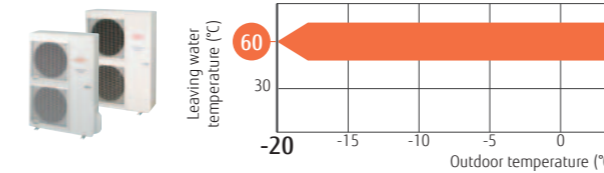

At -10°C outdoor temperature: 55°C Hot water

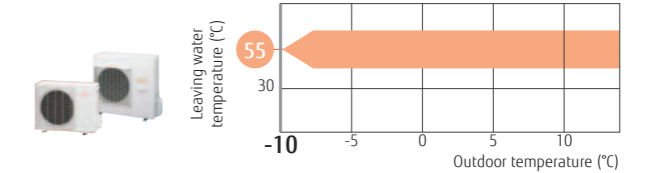

* If you want to raise the hot water supply temperature, backup heaters can be used for auxiliary operation.

High COP

Air to water heat pumps work with much more efficiency and save more energy than a traditional heating system.



Condition : Outdoor Temp. 7°C Heating Temp. 35°C

2 Zone individual control*

2 Zone individual control (2 under floor heating zones or under floor heating + radiator zone, etc.)*

*: Optional parts are required.

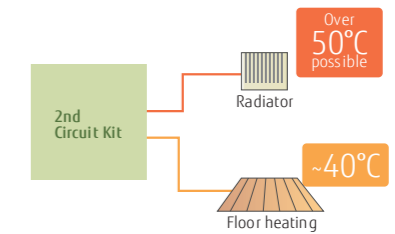

Automatic heating curve control

Automatic temperature regulation in accordance with heating curve (Depends on heating terminal and outdoor temperature)

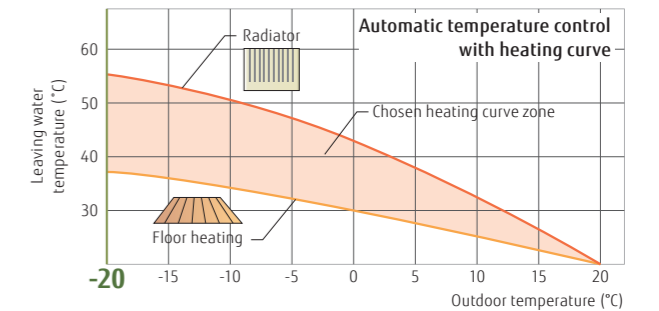

High durability

- Corrosion protected
- No flow switch necessary
- Anti-freeze-protection is unnecessary

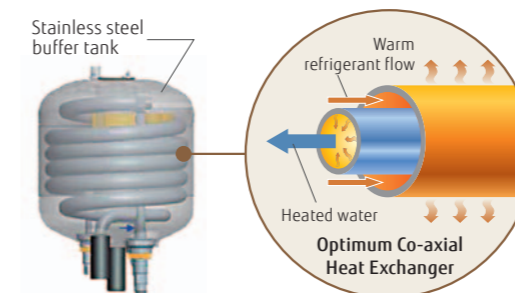

Emergency operation

System can continuously supply hot water by built in back up heater or boiler, as emergency, even if an error has occurred.

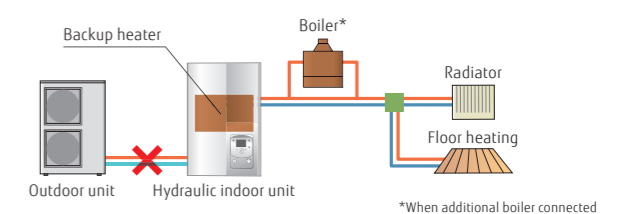

*When additional boiler connected

Monobloc Type Comfort series



Compact series
Hydraulic indoor unit: WSYP100DG6
Outdoor unit : WPYA050LG / WPYA080LG / WPYA100LG



Features

High leaving water temperature

High leaving water temperature of 55°C keeps to -20°C outdoor temperature without additional heater.

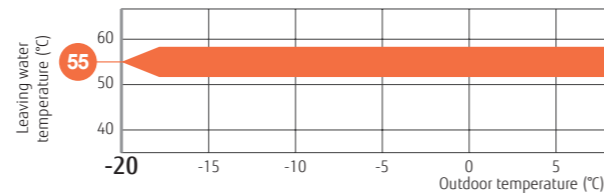

High COP

High COP is realized by using a DC twin rotary compressor, inverter technology, and high efficient water heat exchanger.

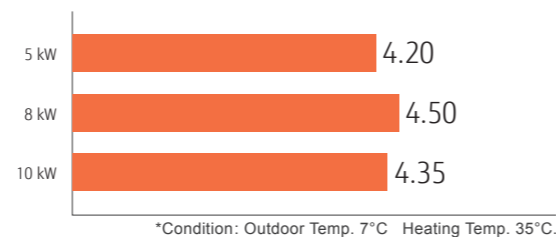

Compact & light weight design

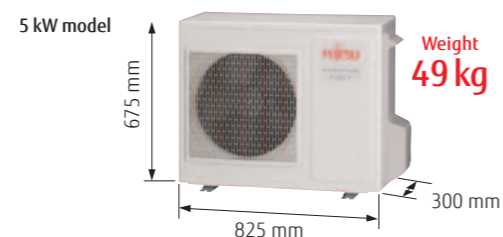

Features of the hydraulic indoor unit

- The compact Indoor unit provides two electrical back up heater, each with 3kW capacity.
- 12 L expansion vessel included
- No waste of space. DHW Kit installation inside the hydraulic unit possible.
- New generation controller. Connection by MODBUS protocol possible.
- Integrated heat metering (flow sensor included).



Common Features

Smart & Comfort Control



Navigation and setting

- Selecting the heating menu
- Setting program timer

Large LCD panel

- Operation status display
- Error display
- Plain text

Simple operation mode setting

- Selecting the heating mode and Domestic hot water operation

Heating mode

- Auto** Automatic mode
Comfort/Reduce mode switching automatically according to outdoor temperature
- Reduce mode**
Constant reduce temperature
- Comfort mode**
Constant comfort temperature
- Protection mode**
Stand-by mode with anti-frost protection

Automatic heating curve operation

Automatic heating curve control based on outdoor temperature and setting room temperature. This can be adjusted when too warm or too cold.

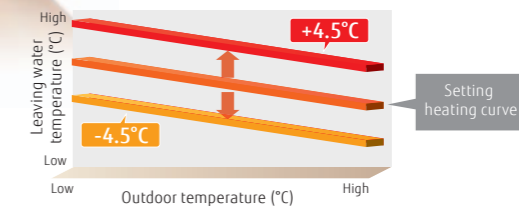

Programmable timer

- The setting of timer operation can easily be adjusted.
- Changing the heating mode linked with time is possible.

Day-Weekly timer setting

- The day-weekly timer can be set up for up to 3 times per day.
- Allows separate settings for each day of the week.

Day-Weekly timer setting

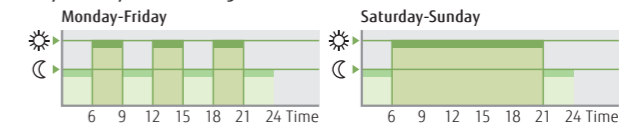

Holiday timer setting

- The holiday timer can be set for up to 8 periods
- If you are absent for a long time in the winter, freezing of room can be prevented.

Holiday timer setting

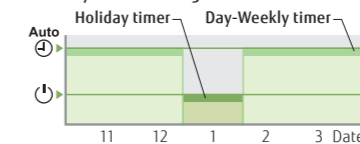

Auto-changeover

If the cooling operation function is set, the system can automatically switch to cooling or heating, depending on the outdoor temperature to provide all-season comfortable air conditioner.

Remote control-extension

Various remote controls are available on your hands. Remote control is also available via Web. All kinds of life styles are supported.

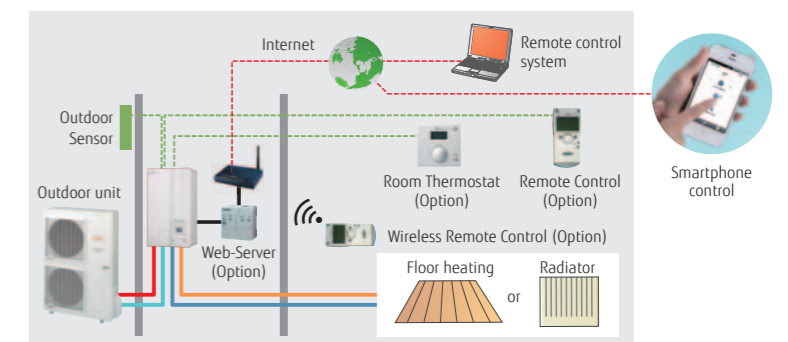

Case Studies

Split Case studies

2 emitter simultaneous heating (Individual control)

Floor heating + Radiator

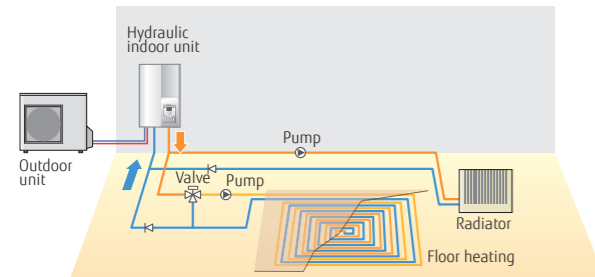

3 types of heat distribution

Floor heating + Radiator + Domestic Hot Water

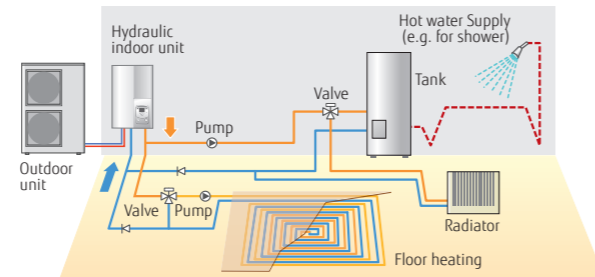

Boiler connected to heating (Boiler + Heating)

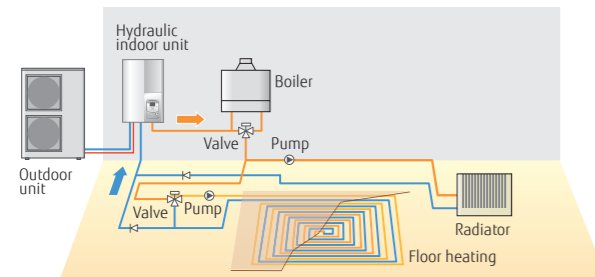

Split DHW integrated Case studies

Single heating & Domestic Hot Water

Radiator + Domestic Hot Water

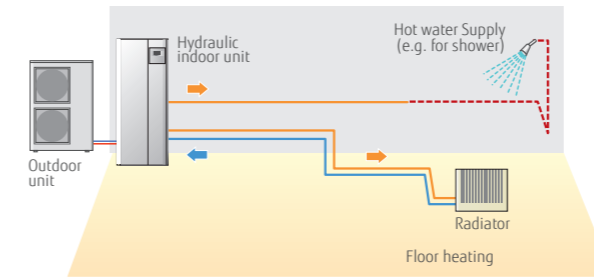

Boiler connected to heating (Boiler + Heating) & Domestic Hot Water

Radiator + Domestic Hot Water

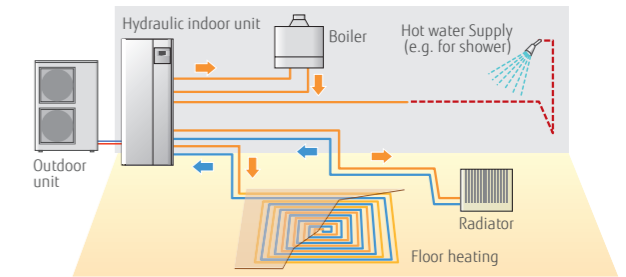

2 emitter simultaneous heating (Individual control) & Domestic Hot Water

Radiator + Domestic Hot Water

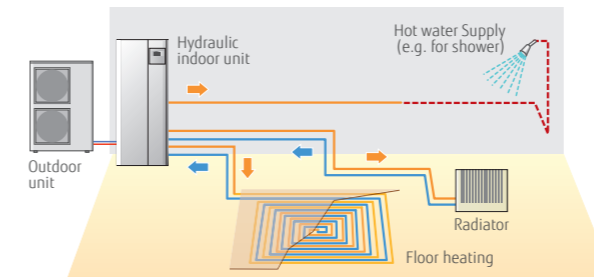

Split Cascade System Case studies

2 emitter simultaneous heating (Individual control)

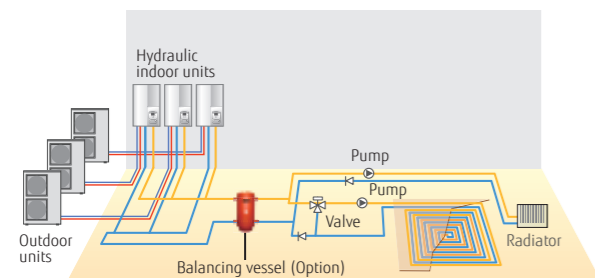

2 emitter simultaneous heating & Domestic Hot Water (type A)

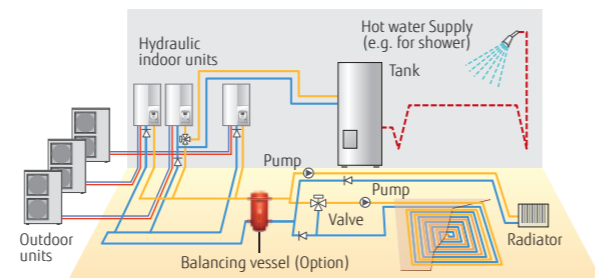

Boiler connected to heating (Boiler + Heating)

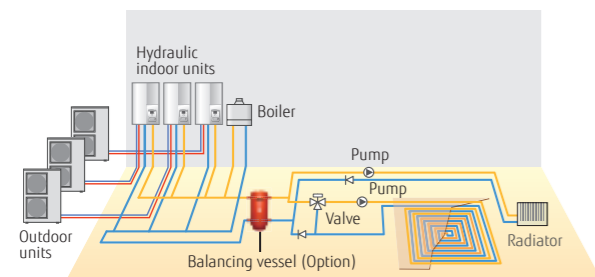

2 emitter simultaneous heating & Domestic Hot Water (type B)

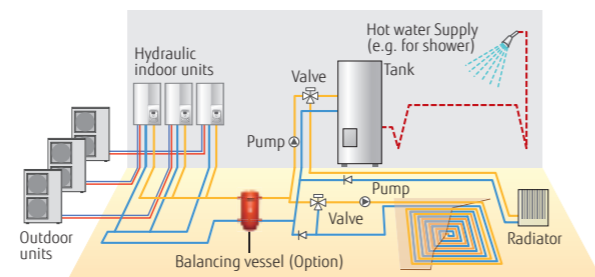

Monobloc Case studies

Single heating system

Floor heating

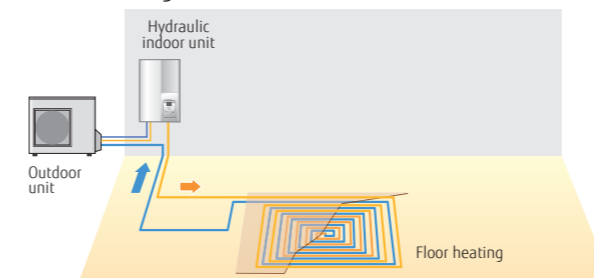

2 types of heat distribution

Floor heating + Domestic Hot Water

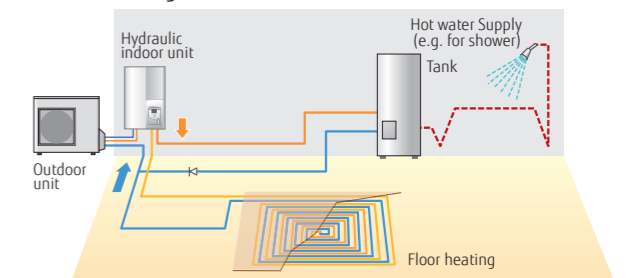

Boiler connected to heating (Boiler + Heating)

Floor heating

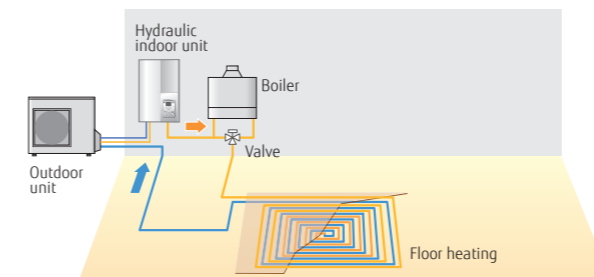

Optional Parts

Product Name	Model Name	Split										Split DHW integrated type										Monobloc									
		High Power					Comfort					High Power					Comfort					Compact									
		1Ø		3Ø			1Ø		3Ø			1Ø		3Ø			1Ø		1Ø												
		11	14	11	14	16	5	6	8	10	11	14	11	14	16	5	6	8	10	11	14	11	14	16	5	6	8	10	5	8	10
2nd Circuit Kit	 UTW-KZSXE	●	●	●	●	●	●	●	●	●	-	-	-	-	-	-	-	-	-	-	-	-	-	-	-	-	-	-	-	-	-
	 UTW-KZDXE	-	-	-	-	-	-	-	-	-	●	●	●	●	●	●	●	●	●	●	-	-	-	-	-	-	-	-	-	-	-
Boiler Connection kit	 UTW-KBSXD	●	●	●	●	●	●	●	●	-	-	-	-	-	-	-	-	-	-	-	-	-	-	-	-	-	-	-	-	-	-
	 UTW-KBDXD	-	-	-	-	-	-	-	-	-	●	●	●	●	●	●	●	●	●	●	-	-	-	-	-	-	-	-	-	-	-
Balancing vessel	 UTW-TEVXA	●	●	●	●	●	●	●	●	●	●	●	●	●	●	●	●	●	●	●	●	●	●	●	●	●	●	●	●	●	●
DHW kit	 UTW-KDWXG (Internal)	-	-	-	-	-	-	-	-	-	-	-	-	-	-	-	-	-	-	-	-	-	-	-	-	-	-	●	●	●	
	 UTW-KDWXD (External)	●	●	●	●	●	●	●	●	●	_*1	_*1	_*1	_*1	_*1	_*1	_*1	_*1	_*1	_*1	_*1	_*1	_*1	_*1	_*1	_*1	_*1	_*1	_*1	_*1	_*1
DHW tank	 200 Liter 300 Liter UTW-T20XA UTW-T30XA	●	●	●	●	●	●	●	●	●	_*1	_*1	_*1	_*1	_*1	_*1	_*1	_*1	_*1	_*1	_*1	_*1	_*1	_*1	_*1	_*1	_*1	_*1	_*1	_*1	_*1
	 300 Liter UTW-T30XD	●	●	●	●	●	●	●	●	●	_*1	_*1	_*1	_*1	_*1	_*1	_*1	_*1	_*1	_*1	_*1	_*1	_*1	_*1	_*1	_*1	_*1	_*1	_*1	_*1	_*1
Circulating pump	 UTW-PHFXG	●	●	●	●	●	-	-	-	-	●	●	●	●	●	-	-	-	-	-	-	-	-	-	-	-	-	-	-	-	-
Swimming Pool kit	 UTW-KSPXD	●	●	●	●	●	●	●	●	●	●	●	●	●	●	●	●	●	●	●	●	●	●	●	●	●	●	●	●	●	●
Heat Exchanger for swimming pool kit	 UTW-ESPPXA	●	●	●	●	●	●	●	●	●	●	●	●	●	●	●	●	●	●	●	●	●	●	●	●	●	●	●	●	●	●
Cooling kit	 UTW-KCLXD	●	●	●	●	●	●	●	●	●	●	●	●	●	●	●	●	●	●	●	●	●	●	●	●	●	●	_*2	_*2	_*2	_*2
Regulation Extension Kit	 UTW-KREXD	●	●	●	●	●	●	●	●	●	●	●	●	●	●	●	●	●	●	●	●	●	●	●	●	●	●	●	●	●	●
Low Noise Kit	 UTW-KLNXE	●	●	●	●	●	-	-	-	-	●	●	●	●	●	-	-	-	-	-	-	-	-	-	-	-	-	-	-	-	-
Drain Pan	 UTW-KDPXA	-	-	-	-	-	●	●	●	-	-	-	-	-	-	-	-	-	-	-	-	-	-	-	-	-	-	-	-	-	-
Cascade Master Kit (incl. LPB Clip)	 UTW-KCMXE	●	●	●	●	●	-	-	-	●	-	-	-	-	-	-	-	-	-	-	-	-	-	-	-	-	-	-	-	-	-
Cascade Slave Kit (incl. LPB Clip)	 UTW-KCSXE	●	●	●	●	●	-	-	-	●	-	-	-	-	-	-	-	-	-	-	-	-	-	-	-	-	-	-	-	-	-

Product Name	Model Name	Split										Split DHW integrated type										Monobloc									
		High Power					Comfort					High Power					Comfort					Compact									
		1Ø		3Ø			1Ø		3Ø			1Ø		3Ø			1Ø		1Ø												
		11	14	11	14	16	5	6	8	10	11	14	11	14	16	5	6	8	10	11	14	11	14	16	5	6	8	10	5	8	10
HMI Kit	 UTW-KHMXE*3	●	●	●	●	●	●	●	●	●	●	●	●	●	●	●	●	●	●	●	●	●	●	●	●	●	●	●	●	●	●
	 UTW-C74TXF*3	●	●	●	●	●	●	●	●	●	●	●	●	●	●	●	●	●	●	●	●	●	●	●	●	●	●	●	●	●	●
Remote Controller	 Wired UTW-C74HXF*3	●	●	●	●	●	●	●	●	●	●	●	●	●	●	●	●	●	●	●	●	●	●	●	●	●	●	●	●	●	●
	 Wireless UTW-C78XD	●	●	●	●	●	●	●	●	●	●	●	●	●	●	●	●	●	●	●	●	●	●	●	●	●	●	●	●	●	●
Room Thermostat	 UTW-C78XD-E*4	●	●	●	●	●	●	●	●	●	●	●	●	●	●	●	●	●	●	●	●	●	●	●	●	●	●	●	●	●	●
	 Wired UTW-C55XA	●	●	●	●	●	●	●	●	●	●	●	●	●	●	●	●	●	●	●	●	●	●	●	●	●	●	●	●	●	●
RF Modules for BSB-Port	 Wireless UTW-C58XD	●	●	●	●	●	●	●	●	●	●	●	●	●	●	●	●	●	●	●	●	●	●	●	●	●	●	●	●	●	●
	 UTW-MOSXD	●	●	●	●	●	●	●	●	●	●	●	●	●	●	●	●	●	●	●	●	●	●	●	●	●	●	●	●	●	●
Web server	 UTW-MRCXD	●	●	●	●	●	●	●	●	●	●	●	●	●	●	●	●	●	●	●	●	●	●	●	●	●	●	●	●	●	●
LPB Clip	 UTW-KW1XD	●	●	●	●	●	●	●	●	●	●	●	●	●	●	●	●	●	●	●	●	●	●	●	●	●	●	●	●	●	●
	 UTW-KW4XD	●	●	●	●	●	●	●	●	●	●	●	●	●	●	●	●	●	●	●	●	●	●	●	●	●	●	●	●	●	●
MODBUS Clip	 UTW-KL1XD	_*7	_*7	_*7	_*7	_*7	_*7	_*7	_*7	_*7	_*7	_*7	_*7	_*7	_*7	_*7	_*7	_*7	_*7	_*7	_*7	_*7	_*7	_*7	_*7	_*7	_*7	_*7	_*7	_*7	_*7
Base Heater	 UTW-KMBXE	-	-	-	-	-	-	-	-	-	-	-	-	-	-	-	-	-	-	-	-	-	-	-	-	-	-	-	-	-	-
	 UTW-HAMXE	-	-	-	-	-	-	-	-	-	-	-	-	-	-	-	-	-	-	-	-	-	-	-	-	-	-	-	-	-	-
Service Tool (incl. OC1700 adaptor)	 UTW-HAMXF	-	-	-	-	-	-	-	-	-	-	-	-	-	-	-	-	-	-	-	-	-	-	-	-	-	-	-	-	-	-
	 UTW-KSTXD	_*5	_*5	_*5	_*5	_*5	_*5	_*5	_*5	_*5	_*5	_*5	_*5	_*5	_*5	_*5	_*5	_*5	_*5	_*5	_*5	_*5	_*5	_*5	_*5	_*5	_*5	_*5	_*5	_*5	_*5
Service Tool Software	 UTW-KPSXD	_*6	_*6	_*6	_*6	_*6	_*6	_*6	_*6	_*6	_*6	_*6	_*6	_*6	_*6	_*6	_*6	_*6	_*6	_*6	_*6	_*6	_*6	_*6	_*6	_*6	_*6	_*6	_*6	_*6	_*6
External connect kit	 UTW-KWZXD	●	●	●	●	●	-	-	-	-	●	●	●	●	●	-	-	-	-	●	●	●	●	●	-	-	-	-	-	-	

*1: DHW operation is possible without DHW Kit and DHW Tank. ●: Available -: Not Available
 *2: Cooling operation is possible without cooling kit
 *3: 19 Languages included, no separate Eastern European RC necessary. C74TXF: Built in Room Temperature sensor C74HXF: Built in Room temperature and Humidity sensor
 *4: Eastern European Language(English, Czech Republic, Slovakia, Poland, Turkey, Hungary, Russia, Slovenia, Greece, Serbia)
 *5: UTW-KL1XD is required for the connection.
 *6: UTW-KW1XD or UTW-KW4XD is required for the connection.
 *7: Additional optional part necessary

Installation Limitations

Equipment Installation

Split type Hydraulic indoor unit

- Hydraulic indoor unit is to be hang on the wall
- Weight < 65 kg (including water)
- Space for maintenance should be respected

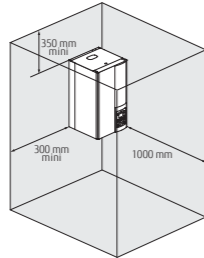

Split DHW integrated type Hydraulic indoor unit

- Floor stand
- Weight 366 kg (including water)
- Space for maintenance should be respected.

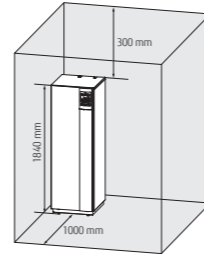

Monobloc Type Hydraulic indoor unit

- Hydraulic indoor unit is to be hang on the wall
- Weight < 62 kg (including water)
- Distances for maintenance should be respected

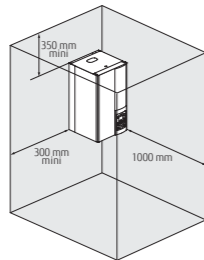

Monobloc type Outdoor unit

- Floor stand
- Weight 72 kg (without water): WPYA080LG, WPYA100LG
- 49 kg (without water): WPYA050LG
- Distances for maintenance should be kept

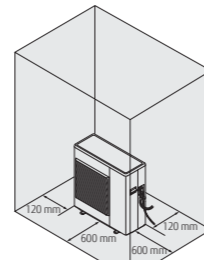

Piping and Wiring

Split type

Series	Capacity range(kW)	H (m)	L (m)
Comfort	5	±20	5-30
	6		
	8		
	10		
High power	11	±15	5-20
	14		
	16		

Electrical wiring

Split type

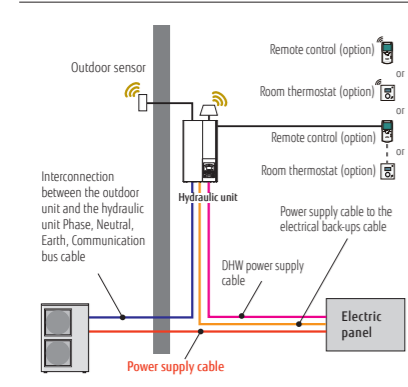

Split DHW integrated type

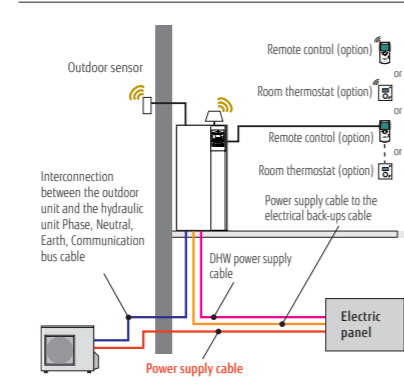

Monobloc Type with Hydraulic indoor unit

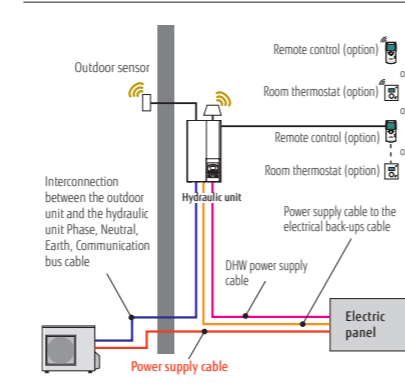

Specifications & Dimensions

Split type Specifications (High power series)

Model Name	Hydraulic indoor unit	WSYG140DG6	WSYG140DG6	WSYK160DG9	WSYK160DG9	WSYK160DG9
Capacity range	Outdoor unit	WOYG112LCTA	WOYG140LCTA	WOYK112LCTA	WOYK140LCTA	WOYK160LCTA
7°C/35°C floor heating *1	Heating capacity	11	14	11	14	16
	Input power	10.80	13.50	10.80	13.50	15.17
	COP	2.54	3.23	2.51	3.20	3.70
2°C/35°C floor heating *1	Heating capacity	4.25	4.18	4.30	4.22	4.10
	Input power	10.77	12.00	10.77	13.00	13.50
	COP	3.44	3.87	3.40	4.15	4.34
-7°C/35°C floor heating*1	Heating capacity	3.13	3.10	3.17	3.13	3.11
	Input power	10.38	11.54	10.38	12.20	13.50
	COP	4.32	5.08	4.28	5.13	5.40
Space heating characteristics*2						
Temperature application	°C	55	35	55	35	55
Energy efficiency class		A+	A++	A+	A+	A+
Rated heat output(P _{rated})	kW	9	11	11	13	14
Seasonal space heating energy efficiency(η _s)	%	109	151	113	148	112
Annual energy consumption	kWh	6842	6062	8041	6824	6669
Sound power level	Hydraulic indoor unit	46				
	Outdoor unit	68				
Hydraulic indoor unit Specification		1 Ø 230 V 50 Hz				
Power source		3 N 400 V 50 Hz				
Dimensions H×W×D	mm	800 × 450 × 457				
Weight (Net)	kg	42				
Water circulation	Min/Max	19.5/39.0				
Buffer tank capacity	L	24.4/48.7				
Expansion vessel capacity	L	19.5/39.0				
Leaving water temperature range	Max	16				
Water pipe connection diameter	Flow/Return	8				
Backup heater	Capacity	60				
Outdoor unit specification		1 Ø 230 V 50 Hz				
Power source		3 N 400 V 50 Hz				
Current	Max	22.0				
Dimensions H × W × D	mm	25.0				
Weight (Net)	kg	1,290 × 900 × 330				
Refrigerant	Type (Global Warming Potential)	R410A (2,088)				
Charge	kg	2.50				
Additional refrigerant charge amount	g/m	50				
Connection pipe	Diameter	Ø 9.52				
	Length	Ø 15.88				
	Length(Pre-charge)	5/20				
	Height difference	15				
Operation range	Max	15				
	Heating	-25 to 35				

*1:The values of heating capacity/input power/COP are based on measurement of EN14511 standard. Usage environment, such as operation of the heating equipment, room temperature, and controller adjustments, may cause disparities between practically determined values and these values.

*2:All information of ErP can be available for downloaded from www.fujitsu-general.com/global/products/erp-ecodesign/index.html.

Split type Dimensions (High power series)

Outdoor Unit : WOYG112LCTA/WOYG140LCTA

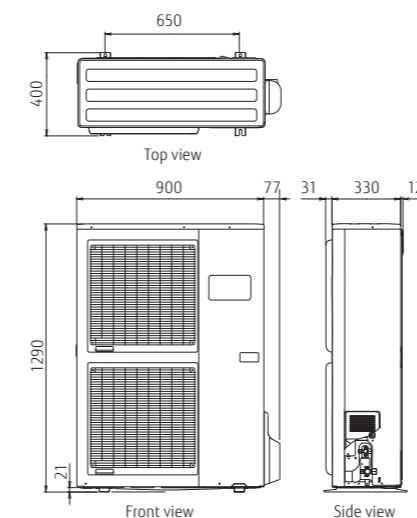

Outdoor Unit : WOYK112LCTA/WOYK140LCTA/WOYK160LCTA

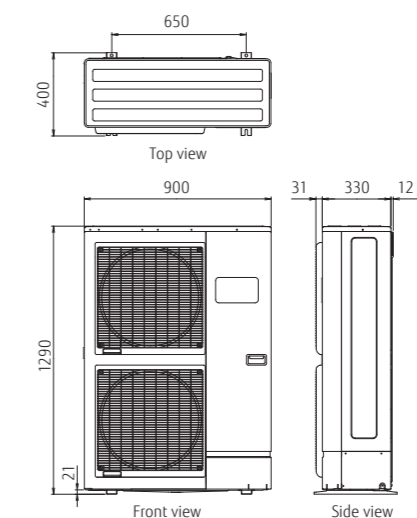

Hydraulic Indoor Unit : WSYG140DG6/WSYK160DG9

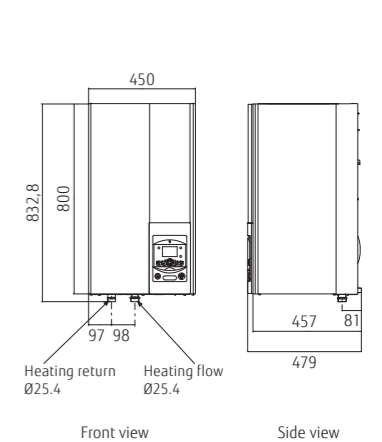

Split type Specifications (Comfort series)

Model Name	Hydraulic indoor unit Outdoor unit	WSYA050DG6 WOYA060LFCA	WSYA100DG6 WOYA060LFCA	WSYA100DG6 WOYA080LFCA	WSYA100DG6 WOYA100LFTA				
Capacity range		5	6	8	10				
7°C/35°C floor heating *1	Heating capacity	4.50	6.00	7.50	10.00				
	Input power	0.996	1.41	1.84	2.49				
	COP	4.52	4.27	4.08	4.02				
2°C/35°C floor heating *1	Heating capacity	4.50	4.95	5.65	7.70				
	Input power	1.39	1.53	1.78	2.47				
	COP	3.24	3.24	3.17	3.12				
-7°C/35°C floor heating*1	Heating capacity	4.10	4.60	5.70	7.40				
	Input power	1.47	1.74	2.23	2.97				
	COP	2.79	2.64	2.56	2.49				
Space heating characteristics*2									
Temperature application	°C	55	35	55	35	55	35	55	35
Energy efficiency class		A+	A++	A+	A++	A+	A++	A+	A++
Rated heat output (P _{rated})	kW	4	4	5	5	6	7	8	8
Seasonal space heating energy efficiency (η _s)	%	115	169	115	169	118	156	113	155
Annual energy consumption	kWh	3026	2160	3180	2505	3886	3375	5415	4415
Sound power level	Hydraulic indoor unit	46		46		46		46	
	Outdoor unit	65	60	65	63	65	69	68	69
Hydraulic indoor unit Specification									
Power source		1 Ø 230 V 50 Hz							
Dimensions H×W×D	mm	800 × 450 × 457							
Weight (Net)	kg	42							
Water circulation	Min/Max	L/min		L/min					
Buffer tank capacity	L	16							
Expansion vessel capacity	L	8							
Leaving water temperature range	Max	°C							
Water pipe connection diameter	Flow/Return	mm							
Backup heater	Capacity	kW							
Outdoor unit specification									
Power source		1 Ø 230 V 50 Hz							
Current	Max	A		A					
Dimensions H × W × D	mm	620 × 790 × 290		830 × 900 × 330					
Weight (Net)	kg	41		42					
Refrigerant	Type (Global Warming Potential)	R410A (2,088)							
Additional refrigerant charge amount	Charge	kg		kg					
		1.10		1.40					
Connection pipe	Diameter	Liquid	mm		mm				
		Gas	mm		mm				
	Length	Min/Max	m		m				
Operation range	Heating	°C							
		-20 to 35							

*1: The values of heating capacity/input power/COP are based on measurement of EN14511 standard. Usage environment, such as operation of the heating equipment, room temperature, and controller adjustments, may cause disparities between practically determined values and these values.

*2: All information of ErP can be available for downloaded from www.fujitsu-general.com/global/products/erp-ecodesign/index.html.

Split type Dimensions (Comfort series)

Outdoor Unit :
WOYA060LFCA/WOYA080LFCA

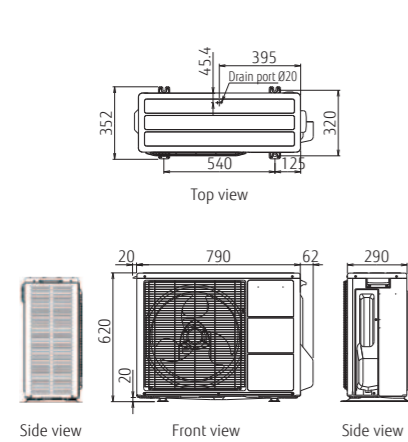

Outdoor Unit :
WOYA100LFTA

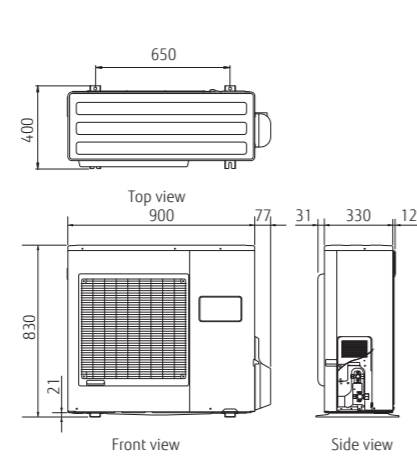

Hydraulic Indoor Unit :
WSYA050DG6/WSYA100DG6

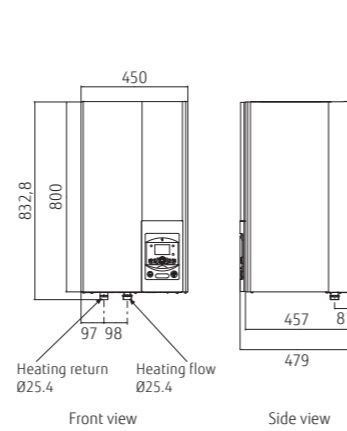

Split DHW Integrated type Specifications (High power series)

Model Name	Hydraulic indoor unit Outdoor unit	WYG140DG6 WOYG112LCTA	WYG140DG6 WOYG140LCTA	WGYK160DG9 WOYK112LCTA	WGYK160DG9 WOYK140LCTA	WGYK160DG9 WOYK160LCTA	
Capacity range		11	14	11	14	16	
7°C/35°C floor heating *1	Heating capacity	10.80	13.50	10.80	13.50	15.17	
	Input power	2.54	3.23	2.51	3.20	3.70	
	COP	4.25	4.18	4.30	4.22	4.10	
2°C/35°C floor heating *1	Heating capacity	10.77	12.00	10.77	13.00	13.50	
	Input power	3.44	3.87	3.40	4.15	4.34	
	COP	3.13	3.10	3.17	3.13	3.11	
-7°C/35°C floor heating*1	Heating capacity	10.38	11.54	10.38	12.20	13.50	
	Input power	4.32	5.08	4.28	5.13	5.40	
	COP	2.40	2.27	2.43	2.38	2.50	
Space heating characteristics*2							
Temperature application	°C	55	35	55	35	55	35
Energy efficiency class		A+	A++	A+	A+	A+	A+
Rated heat output (P _{rated})	kW	9	11	11	13	9	11
Seasonal space heating energy efficiency (η _s)	%	109	151	113	148	112	154
Annual energy consumption	kWh	6842	6062	8041	6824	6669	5930
Sound power level	Hydraulic indoor unit	46		46		46	
	Outdoor unit	68	69	69	68	70	68
Domestic hot water characteristics*2							
Load profile		L					
Energy efficiency class		A					
Energy efficiency (η _{wh})	%	88					
Annual electricity consumption	kWh	1166					
Hydraulic indoor unit Specification							
Power source		1 Ø 230 V 50 Hz			3 N 400 V 50 Hz		
Dimensions H×W×D	mm	1,840 × 648 × 698			1,840 × 648 × 698		
Weight (Net)	kg	152					
Water circulation	L/min	19.5/39.0	24.4/28.7	19.5/39.0	24.4/48.7	27.4/54.8	
DHW capacity	L	190					
Hot water heater capacity	kW	1.5					
Expansion vessel capacity	L	12					
Leaving water temperature range	Max	°C					
Water pipe connection diameter	Flow/Return	mm					
Hot water pipe connection diameter		mm					
Backup heater	Capacity	6.0(3.0kW×2pcs.)		9.0(3.0kW×3pcs.)			
Outdoor unit specification							
Power source		1 Ø 230 V 50 Hz			3 N 400 V 50 Hz		
Current	Max	A		A			
Dimensions H × W × D	mm	22.0		25.0			
Weight (Net)	kg	92		99			
Refrigerant	Type (Global Warming Potential)	R410A (2,088)					
Additional refrigerant charge amount	Charge	kg		kg			
		2.50		2.50			
Connection pipe	Diameter	Liquid	mm		mm		
		Gas	mm		mm		
	Length	Min/Max	m		m		
Operation range	Heating	°C					
		-25 to 35					

*1: The values of heating capacity/input power/COP are based on measurement of EN14511 standard. Usage environment, such as operation of the heating equipment, room temperature, and controller adjustments, may cause disparities between practically determined values and these values.

*2: All information of ErP can be available for downloaded from www.fujitsu-general.com/global/products/erp-ecodesign/index.html.

Split DHW Integrated type Dimensions (High power series)

Outdoor Unit :
WOYG112LCTA/WOYG140LCTA

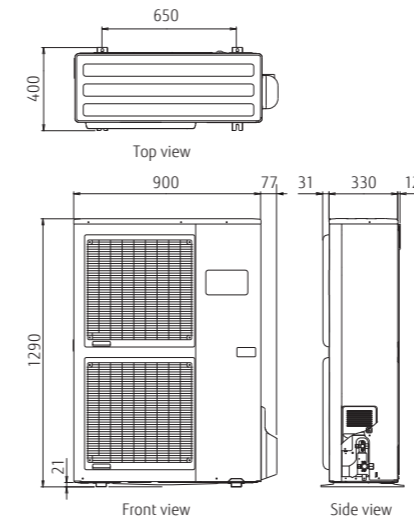

Outdoor Unit :
WOYK112LCTA/WOYK140LCTA/WOYK160LCTA

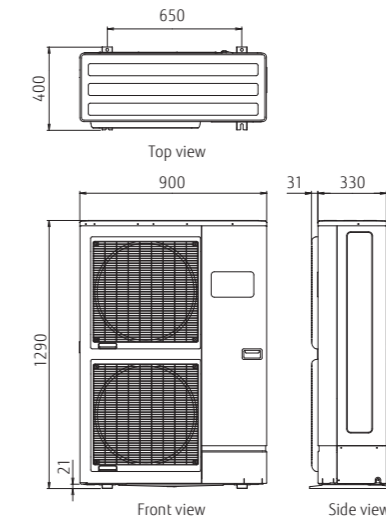

Hydraulic Indoor Unit :
WYG140DG6/WGYK160DG9

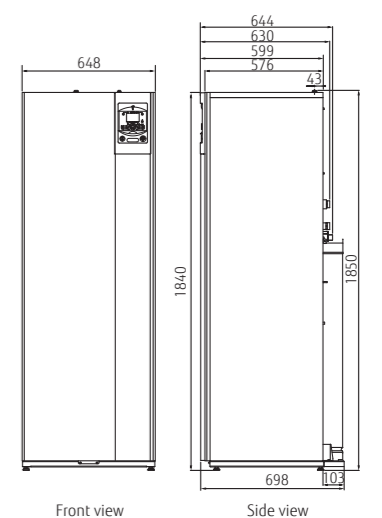

Split DHW Integrated type Specifications (Comfort series)

Model Name	Hydraulic indoor unit	WGYA050DG6		WGYA100DG6		WGYA100DG6		WGYA100DG6		
	Outdoor unit	WOYA060LFCA		WOYA060LFCA		WOYA080LFCA		WOYA100LFTA		
Capacity range		5		6		8		10		
7°C/35°C floor heating *1	Heating capacity	4.50		6.00		7.50		10.00		
	Input power	0.996		1.41		1.84		2.49		
	COP	4.52		4.27		4.08		4.02		
2°C/35°C floor heating *1	Heating capacity	4.50		4.95		5.65		7.70		
	Input power	1.39		1.53		1.78		2.47		
	COP	3.24		3.24		3.17		3.12		
-7°C/35°C floor heating*1	Heating capacity	4.10		4.60		5.70		7.40		
	Input power	1.47		1.74		2.23		2.97		
	COP	2.79		2.64		2.56		2.49		
Space heating characteristics*2										
Temperature application	°C	55	35	55	35	55	35	55	35	
Energy efficiency class		A+	A++	A+	A++	A+	A++	A+	A++	
Rated heat output(P _{rated})	kW	4	4	5	5	6	7	8	8	
Seasonal space heating energy efficiency(η _s)	%	115	169	115	169	118	156	113	155	
Annual energy consumption	kWh	3026	2160	3180	2505	3886	3375	5415	4415	
Sound power level	Hydraulic indoor unit	46		46		46		46		
	Outdoor unit	65	60	65	63	65	69	68	69	
Domestic hot water characteristics*2										
Load profile		L								
Energy efficiency class		A+								
Energy efficiency(η _{wh})	%	120								
Annual electricity consumption	kWh	880								
Hydraulic indoor unit Specification										
Power source		1 Ø 230 V 50 Hz								
Dimensions H×W×D	mm	1,840× 648 × 698								
Weight (Net)	kg	152								
Water circulation	L/min	8.1/16.2		10.8/21.7		13.5/27.1		18.1/36.1		
DHW capacity	L	190								
Hot water heater capacity	kW	1.5								
Expansion vessel capacity	L	12								
Leaving water temperature range	Max °C	55								
Water pipe connection diameter	Flow/Return mm	Ø 25.4/Ø 25.4								
Hot water pipe connection diameter	mm	Ø 19.05								
Backup heater	Capacity mm	6.0(3.0kW×2pcs.)								
Outdoor unit specification										
Power source		1 Ø 230 V 50 Hz								
Current	Max A	11.0		12.5		17.5		18.5		
Dimensions H × W × D	mm	620 × 790 × 290								
Weight (Net)	kg	41								
Refrigerant	Type (Global Warming Potential)	R410A (2,088)								
	Charge kg	1.10		1.40		1.40		1.80		
Additional refrigerant charge amount	g/m	25								
Connection pipe	Diameter	Liquid mm	Ø 12.70						Ø 6.35	
		Gas mm	Ø 12.70						Ø 9.52	
	Length	Min/Max m	5/30						15	
	Height difference	Max m	20							
Operation range	Heating °C	-20 to 35								

*1:The values of heating capacity/input power/COP are based on measurement of EN14511 standard. Usage environment, such as operation of the heating equipment, room temperature, and controller adjustments, may cause disparities between practically determined values and these values.

*2:All information of ErP can be available for downloaded from www.fujitsu-general.com/global/products/erp-ecodesign/index.html.

Split type Dimensions (Comfort series)

Outdoor Unit :
WOYA060LFCA/WOYA080LFCA

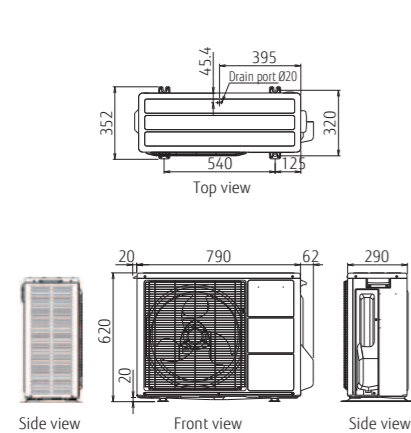

Outdoor Unit :
WOYA100LFTA

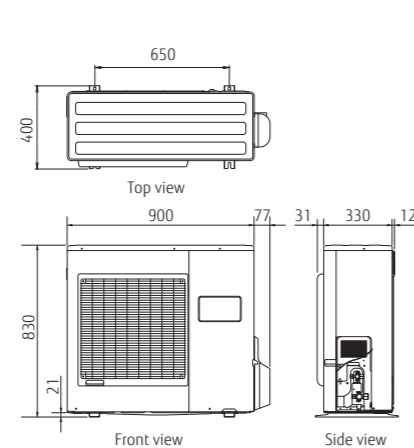

Hydraulic Indoor Unit :
WGYA050DG6/WGYA100DG6

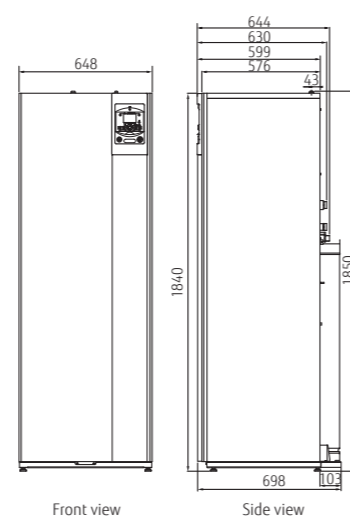

Monobloc type Specifications

Model Name	Hydraulic indoor unit	WSPY100DG6		WSPY100DG6		WSPY100DG6	
	Outdoor unit	WPYA050LG		WPYA080LG		WPYA100LG	
Capacity range		5		8		10	
7°C/35°C floor heating *1	Heating capacity	5.00		8.00		10.00	
	Input power	1.19		1.78		2.30	
	COP	4.20		4.50		4.35	
2°C/35°C floor heating *1	Heating capacity	3.65		4.35		4.90	
	Input power	1.07		1.23		1.44	
	COP	3.40		3.55		3.40	
-7°C/35°C floor heating*1	Heating capacity	3.55		7.10		8.00	
	Input power	1.38		2.93		3.32	
	COP	2.57		2.42		2.41	
Space heating characteristics*2							
Temperature application	°C	55	35	55	35	55	35
Energy efficiency class		A+	A++	A+	A++	A+	A++
Rated heat output(P _{rated})	kW	4	4	6	7	7	8
Seasonal space heating energy efficiency(η _s)	%	118	171	123	168	118	167
Annual energy consumption	kWh	3055	1952	3828	3580	4491	3700
Sound power level	Outdoor unit	62		61		65	
	Indoor unit	65		68		68	
Hydraulic indoor unit Specification							
Power source		1 Ø 230 V 50 Hz					
Dimensions H×W×D	mm	803 × 450 × 457					
Weight (Net)	kg	40					
Buffer tank capacity	L	22					
Expansion vessel capacity	L	12					
Water pipe connection diameter	Flow/Return mm	Ø 25.4/Ø 25.4					
Backup heater	Capacity kW	6.0(3.0kW×2pcs.)					
Outdoor unit specification							
Power source		1 Ø 230 V 50 Hz					
Dimensions H × W × D	mm	675 × 825 × 300		882 × 850 × 330			
Weight (Net)	kg	49		72			
Current	Max A	10.9		15.2		17.5	
Water circulation	Min/Max L/min	5.0/20.0		10.0/30.0			
Water pipe connection diameter	Flow/Return mm	Ø 19.05/Ø 19.05		Ø 25.4/Ø 25.4			
Refrigerant	Type (Global Warming Potential)	R410A (2,088)					
	Charge kg	1.05		1.72		1.72	
Leaving water temperature range	Max °C	55					
Operation range	Heating °C	-20 to 35					

*1:The values of heating capacity/input power/COP are based on measurement of EN14511 standard. Usage environment, such as operation of the heating equipment, room temperature, and controller adjustments, may cause disparities between practically determined values and these values.

*2:All information of ErP can be available for downloaded from www.fujitsu-general.com/global/products/erp-ecodesign/index.html.

Monobloc type Dimensions

Outdoor Unit :
WPYA050LG

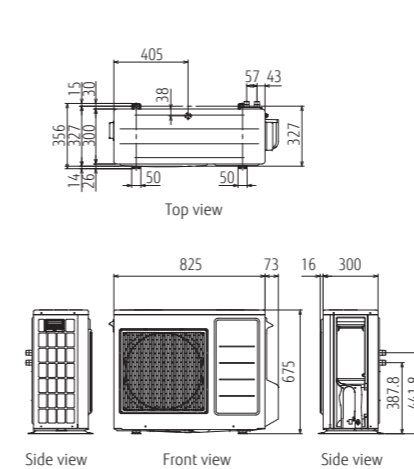

Outdoor Unit :
WPYA080LG/WPYA100LG

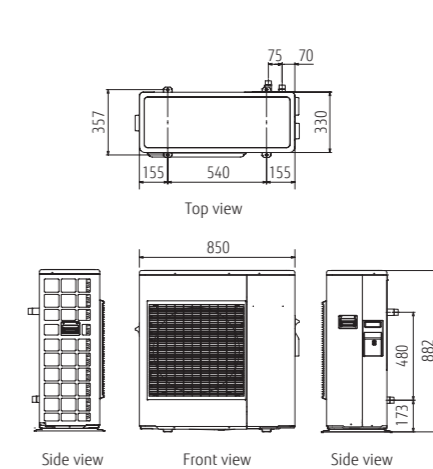

Hydraulic Indoor Unit :
WSPY100DG6

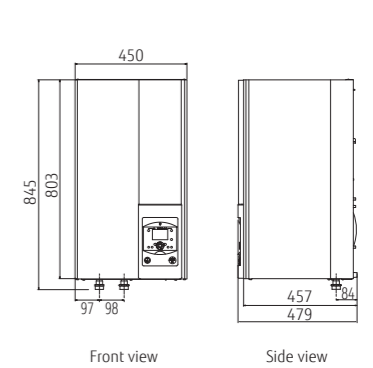

FUJITSU GENERAL LIMITED

3-3-17, Suenaga, Takatsu-ku, Kawasaki 213-8502, Japan
<http://www.fujitsu-general.com/>



Notice for specifications

I.U.=Indoor Unit O.U.=Outdoor Unit Qu=Quiet *=Not decided yet

- Specifications and design are subject to change without notice for future improvement.
- For further details, please check with our authorised dealer.
- Cooling / Heating capacities are based on the following conditions.

Cooling	Indoor temp. : 27°C DB/19°C WB	Heating	Indoor temp. : 20°C DB
	Outdoor temp.: 35°C DB/24°C WB		Outdoor temp.: 7°C DB/6°C WB

- Performance test is in accordance with EN14511
- Seasonal efficiency test is on accordance with EN14825
- Sound power test is in accordance with EN12102

- The products or equipments in this catalogue contain fluorinated greenhouse gases.
- **AIRSTAGE**™ and **WATERSTAGE**™ are worldwide trademarks of FUJITSU GENERAL LIMITED and are registered trademarks in Japan and other countries or areas.
- **nocria**™ is a worldwide trademark of FUJITSU GENERAL LIMITED.
- iPhone and iPad are trademarks of Apple Inc., registered in the U.S. and other countries.
- Other company and product names mentioned herein may be registered trademarks, trademarks or trade names of their respective owners.

• Actual products' colors may be different from the colors shown in this printed material.

Distributed by:

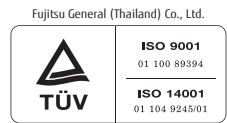

ISO 9001 Certified number: 01 100 89394
 ISO 14001 Certified number: 01 104 9245/01

Fujitsu General (Shanghai) Co., Ltd.



ISO 9001 Certified number: 01 100 79269



ISO 14001 Certified number: CNB311153-UK

Fujitsu General Central Air-conditioner (Wuxi) Co., Ltd.



ISO 9001 Certified number: 15914Q10065R4M
 ISO 14001 Certified number: 15912E10022R3M